

A guidebook intended for use by first responders
during the initial phase of a transportation incident
involving hazardous materials/dangerous goods

2020

EMERGENCY RESPONSE GUIDEBOOK



U.S. Department
of Transportation
**Pipeline and
Hazardous Materials
Safety Administration**



Transport
Canada

Transports
Canada



SCT
SECRETARÍA DE
COMUNICACIONES
Y TRANSPORTES

SHIPPING PAPERS (DOCUMENTS)

For the purpose of this guidebook, shipping documents and shipping papers are synonymous. Shipping papers provide vital information regarding the hazardous materials/dangerous goods to initiate protective actions. A consolidated version of the information found on shipping papers may be found as follows:

- Road – kept in the cab of a motor vehicle
- Rail – kept in possession of a crew member
- Aviation – kept in possession of the pilot or aircraft employees
- Marine – kept in a holder on the bridge of a vessel

Information provided:

- 4-digit identification number, UN or NA (go to yellow pages)
- Proper shipping name (go to blue pages)
- Hazard class or division number of material
- Packing group
- Emergency response telephone number
- Information describing the hazards of the material (entered on or attached to the shipping paper)*

EMERGENCY CONTACT 1-000-000-0000	EXAMPLE OF EMERGENCY CONTACT TELEPHONE NUMBER
CONTRACT #: XX-XXXX-X **	HAZARD CLASS OR DIVISION NO.
UN1219	ISOPROPANOL
3	II
12 000 LITERS	1 TANKTRUCK
ID NUMBER	SHIPPING NAME
	PACKING GROUP

EXAMPLE OF PLACARD AND PANEL WITH ID NUMBER

The 4-digit ID Number may be shown on the diamond-shaped placard or on an adjacent orange panel displayed on the ends and sides of a cargo tank, vehicle or rail car.



A Numbered Placard

OR

A Placard and an Orange Panel



1219

* In the United States, this requirement may be satisfied by attaching a guide from the ERG2020 to the shipping paper, or by having the entire guidebook available for reference.

** In the United States, a registration or contract number may be required on a shipping paper.

HOW TO USE THIS GUIDEBOOK

RESIST RUSHING IN!

APPROACH INCIDENT FROM UPWIND, AND UPHILL AND/OR UPSTREAM

STAY CLEAR OF ALL SPILLS, VAPORS, FUMES, SMOKE, AND POTENTIAL HAZARDS

WARNING: DO NOT USE THIS FLOWCHART if more than one hazardous material/dangerous good is involved. Immediately call the appropriate emergency response agency telephone number listed on the inside back cover of this guidebook.

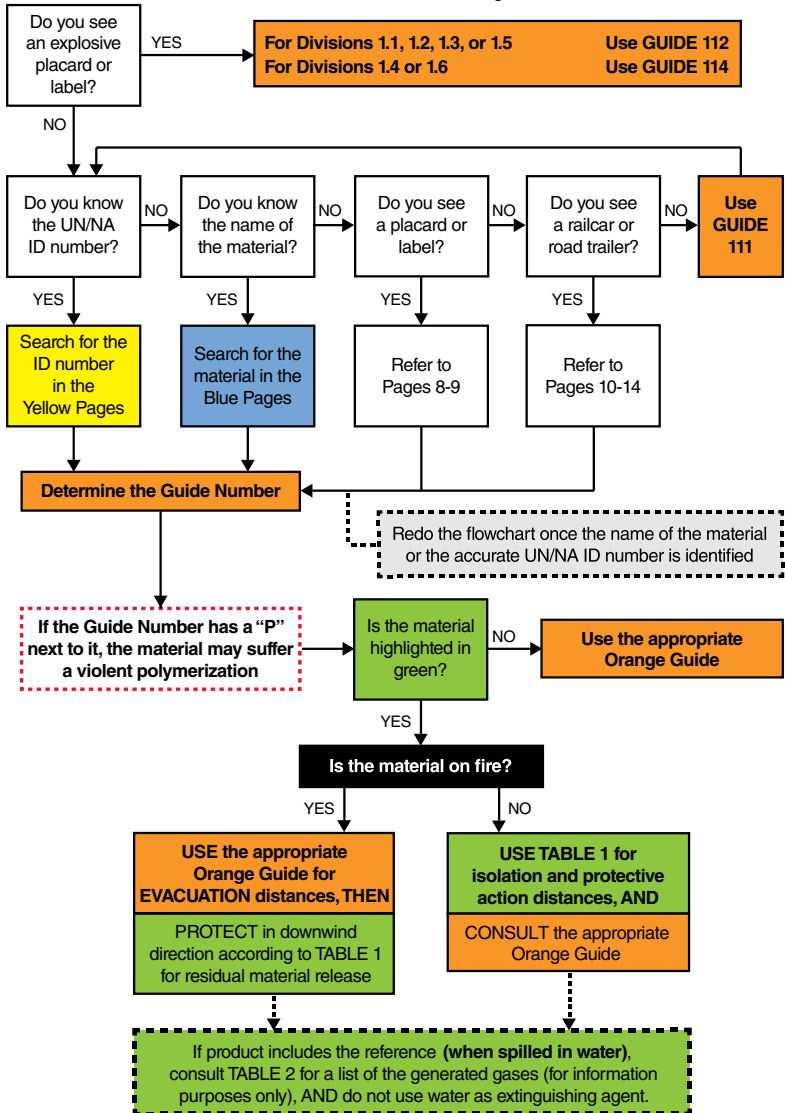

BEFORE AN EMERGENCY - BECOME FAMILIAR WITH THIS GUIDEBOOK!

First responders must be trained in the use of this guidebook.

LOCAL EMERGENCY TELEPHONE NUMBERS

Please populate this page with emergency telephone numbers
for local assistance:

HAZMAT CONTRACTORS

RAIL COMPANIES

FEDERAL/STATE/PROVINCIAL AGENCIES

OTHERS

TABLE OF CONTENTS

Shipping Papers (Documents)	Inside front cover
How to Use this Guidebook	1
Local Emergency Telephone Numbers	2
Safety Precautions	4
Notification and Request for Technical Information	5
Hazard Classification System	6
Introduction to the Table of Markings, Labels And Placards	7
Table of Markings, Labels, and Placards and Initial Response Guide to Use On-scene	8
Rail Car Identification Chart	10
Road Trailer Identification Chart	12
Globally Harmonized System of Classification and Labeling of Chemicals (GHS)	16
Hazard Identification Numbers Displayed On Some Intermodal Containers	18
Pipeline Transportation	22
ID Number Index (yellow pages)	28
Name of Material Index (blue pages)	92
Guides (orange pages)	156
Introduction to Green Tables	286
Protective Actions	289
Protective Action Decision Factors to Consider	291
Background on Table 1 – Initial Isolation and Protective Action Distances	292
Table 1 – Initial Isolation and Protective Action Distances	294
Table 2 – Water-Reactive Materials That Produce Toxic Gases	344
Table 3 – Initial Isolation and Protective Action Distances for Large Spills for Different Quantities of Six Common TIH (PIH in the US) Gases	350
ERG2020 User's Guide	354
Protective Clothing	360
Decontamination	362
Fire and Spill Control	363
BLEVE and Heat Induced Tear	365
BLEVE – Safety Precautions	366
Criminal or Terrorist Use of Chemical, Biological and Radiological Agents	368
Improvised Explosive Device (IED) Safe Stand-Off Distance	373
Glossary	375
Publication Data	386
Canada and United States National Response Centers	389
24-Hour Emergency Response Telephone Numbers	392

SAFETY PRECAUTIONS

RESIST RUSHING IN!

APPROACH CAUTIOUSLY FROM *UPWIND, UPHILL AND/OR UPSTREAM*:

- Stay clear of ***Vapor, Fumes, Smoke and Spills***.
- Keep vehicle at a safe distance from the scene.

SECURE THE SCENE:

- Isolate the area and protect yourself and others.

IDENTIFY THE HAZARDS USING ANY OF THE FOLLOWING:

- Placards
- Container labels
- Shipping papers
- Rail Car and Road Trailer Identification Chart
- Safety Data Sheets (SDS)
- Knowledge of persons on scene
- Consult applicable guide page

ASSESS THE SITUATION:

- Is there a fire, a spill or a leak?
- What are the weather conditions?
- What is the terrain like?
- Who/what is at risk: people, property or the environment?
- What actions should be taken – evacuation, shelter-in-place or dike?
- What resources (human and equipment) are required?
- What can be done immediately?

OBTAIN HELP:

- Advise your headquarters to notify responsible agencies and call for assistance from qualified personnel.

RESPOND:

- Enter only when wearing appropriate protective gear.
- Rescue attempts and protecting property must be weighed against you becoming part of the problem.
- Establish a command post and lines of communication.
- Continually reassess the situation and modify response accordingly.
- Consider safety of people in the immediate area first, including your own safety.

ABOVE ALL: Do not assume that gases or vapors are harmless because of lack of a smell – odorless gases or vapors may be harmful. Use **CAUTION** when handling empty containers because they may still present hazards until they are cleaned and purged of all residues.

NOTIFICATION AND REQUEST FOR TECHNICAL INFORMATION

Follow the steps outlined in your organization's standard operating procedures and/or local emergency response plan for obtaining qualified assistance. Generally, the notification sequence and requests for technical information beyond what is available in this guidebook should occur in the following order:

1. NOTIFY YOUR ORGANIZATION/AGENCY:

- Based on information provided, this will set in motion a series of events. Actions may range from dispatching additional trained personnel to the scene, to activating the local emergency response plan.
- Ensure that local fire and police departments have been notified.

2. CALL THE EMERGENCY RESPONSE TELEPHONE NUMBER ON THE SHIPPING PAPER

- If shipping paper is not available, use guidance under next section "**NATIONAL ASSISTANCE**".

3. NATIONAL ASSISTANCE

- Contact the appropriate emergency response agency listed on the inside back cover of this guidebook.
- Provide as much information about the hazardous material/dangerous good and the nature of the incident.
- The agency will provide immediate advice on handling the early stages of the incident.
- The agency will also contact the shipper or manufacturer of the material for more detailed information if necessary.
- The agency will request on-scene assistance when necessary.

4. PROVIDE AS MUCH OF THE FOLLOWING INFORMATION AS POSSIBLE:

- Your name, call-back telephone number, fax number
- Location and nature of problem (spill, fire, etc.)
- Name and identification number of material(s) involved
- Shipper/consignee/point-of-origin
- Carrier name, rail car or truck number
- Container type and size
- Quantity of material transported/released
- Local conditions (weather, terrain)
- Proximity to schools, hospitals, waterways, etc.
- Injuries and exposures
- Local emergency services that have been notified

HAZARD CLASSIFICATION SYSTEM

The hazard class of hazardous materials/dangerous goods is indicated either by its class (or division) number or name. Placards are used to identify the class or division of a material. The hazard class or division number must be displayed in the lower corner of a placard and is required for both primary and subsidiary hazard classes and divisions, if applicable. For other than Class 7 placards, text indicating a hazard (for example, "CORROSIVE") is not required. Text is shown only in the U.S. The hazard class or division number and subsidiary hazard classes or division numbers placed in parentheses (when applicable), must appear on the shipping paper after each proper shipping name.

Class 1 - Explosives

Division 1.1	Explosives which have a mass explosion hazard
Division 1.2	Explosives which have a projection hazard but not a mass explosion hazard
Division 1.3	Explosives which have a fire hazard and either a minor blast hazard or a minor projection hazard or both, but not a mass explosion hazard
Division 1.4	Explosives which present no significant hazard
Division 1.5	Very insensitive explosives with a mass explosion hazard
Division 1.6	Extremely insensitive articles which do not have a mass explosion hazard

Class 2 - Gases

Division 2.1	Flammable gases
Division 2.2	Non-flammable, non-toxic* gases
Division 2.3	Toxic* gases

Class 3 - Flammable liquids (and Combustible liquids [U.S.]

Class 4 - Flammable solids; Substances liable to spontaneous combustion; Substances which, on contact with water, emit flammable gases

Division 4.1	Flammable solids, self-reactive substances and solid desensitized explosives
Division 4.2	Substances liable to spontaneous combustion
Division 4.3	Substances which in contact with water emit flammable gases

Class 5 - Oxidizing substances and Organic peroxides

Division 5.1	Oxidizing substances
Division 5.2	Organic peroxides

Class 6 - Toxic* substances and Infectious substances

Division 6.1	Toxic* substances
Division 6.2	Infectious substances

Class 7 - Radioactive materials

Class 8 - Corrosive substances

Class 9 - Miscellaneous hazardous materials/dangerous goods and articles

* The words "poison" or "poisonous" are synonymous with the word "toxic".

INTRODUCTION TO THE TABLE OF MARKINGS, LABELS AND PLACARDS

USE THIS TABLE ONLY WHEN THE ID NUMBER OR PROPER SHIPPING NAME IS NOT AVAILABLE.

The next two pages display the placards used on transport vehicles carrying hazardous materials/dangerous goods with the applicable reference GUIDE circled. Follow these steps:

- 1. Approach scene from upwind, uphill and/or upstream at a safe distance to safely identify and/or read the placard or orange panel. Use binoculars if available.**
- 2. Match the vehicle placard(s) with one of the placards displayed on the next two pages.**
- 3. Consult the circled guide number associated with the placard. Use that guide information for now. For example:**

- Use GUIDE **127** for a FLAMMABLE (Class 3) placard



- Use GUIDE **153** for a CORROSIVE (Class 8) placard



- Use GUIDE **111** when the DANGER or DANGEROUS placard is displayed or the nature of the spilled, leaking or burning material is not known. Also use this GUIDE when the presence of hazardous materials/dangerous goods is suspected but no placards can be seen.

If multiple placards point to more than one guide, initially use the most conservative guide (i.e., the guide requiring the greatest degree of protective actions).

- 4. Guides associated with the placards provide the most significant risk and/or hazard information.**
- 5. When specific information, such as ID number or proper shipping name, becomes available, the more specific Guide recommended for that material must be consulted.**
- 6. A single asterisk (*) on orange placards represents an explosive's compatibility group letter. The asterisk must be replaced with the appropriate compatibility group letter. Refer to the Glossary (page 375).**
- 7. Double asterisks (**) on orange placards represent the division of the explosive. The double asterisks must be replaced with the appropriate division number.**

TABLE OF MARKINGS, LABELS, AND PLACARDS

USE THIS TABLE ONLY IF MATERIALS CANNOT BE SPECIFICALLY IDENTIFIED BY

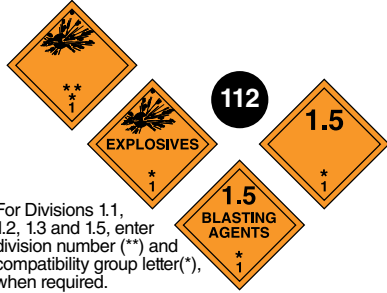
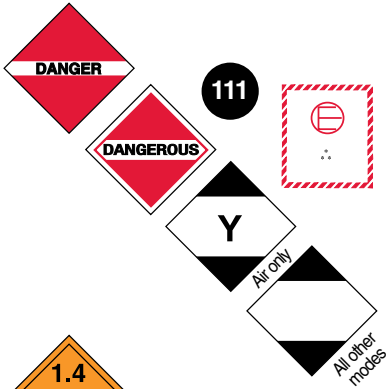

For Divisions 1.1, 1.2, 1.3 and 1.5, enter division number (**) and compatibility group letter(*), when required.

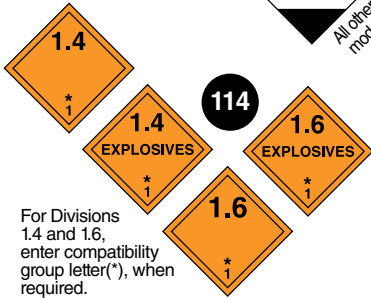

For Divisions 1.4 and 1.6, enter compatibility group letter(*), when required.

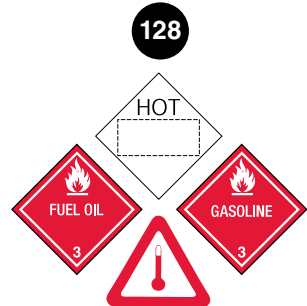
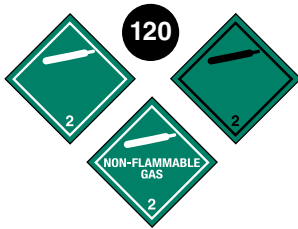
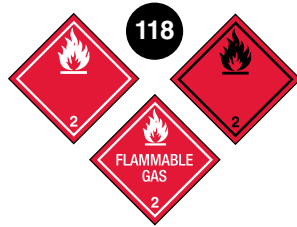

AND INITIAL RESPONSE GUIDE TO USE ON-SCENE

USING THE SHIPPING PAPER, NUMBERED PLACARD, OR ORANGE PANEL NUMBER

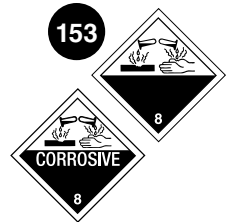
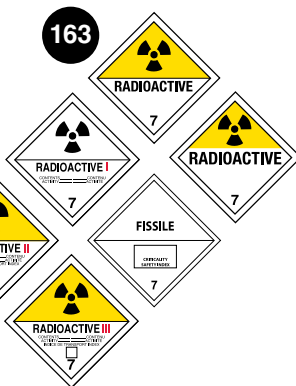
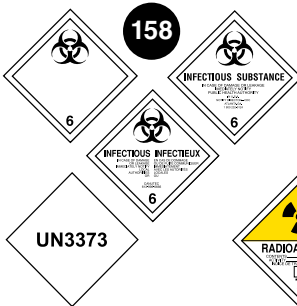
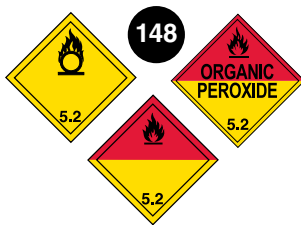

138 Lithium metal batteries (UN3090, UN3091)

147 Lithium ion batteries (UN3480, UN3481)

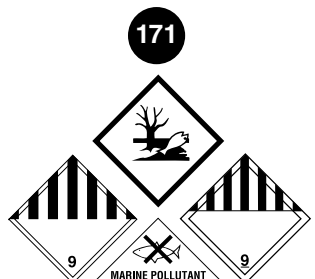

RAIL CAR IDENTIFICATION CHART

CAUTION: Emergency response personnel must be aware that rail tank cars vary widely in construction, fittings and purpose. Tank cars could transport products that may be solids, liquids or gases. The products may be under pressure. It is essential that products be identified by consulting shipping papers or train consist or contacting dispatch centers before emergency response is initiated. The information stenciled on the sides or ends of tank cars, as illustrated below, may be used to identify the product utilizing:

- a. the commodity name shown;
- b. the other information shown, especially reporting marks and car number which, when supplied to a dispatch center, will facilitate the identification of the product.

The recommended guides should be considered as last resort if the material cannot be identified by any other means.

117 Pressure tank car

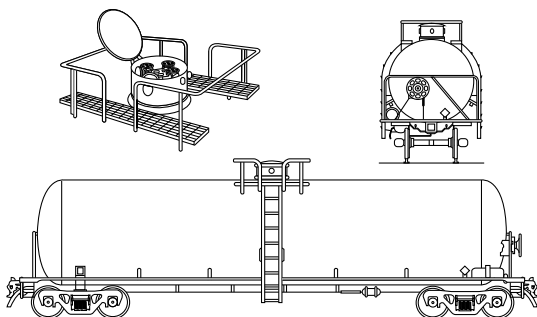

- For flammable, non-flammable, toxic and/or liquefied compressed gases
- Protective housing
- No bottom fittings
- Pressures usually above 40 psi

131 Non-pressure / low pressure tank car

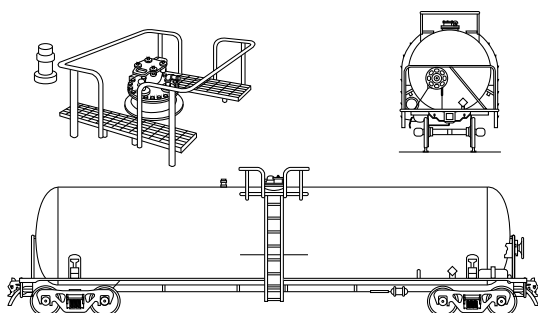

- Known as **general service tank car**
- For variety of hazardous and non-hazardous materials
- Fittings and valves normally visible at the top of the tank
- Some may have bottom outlet valve
- Pressures usually below 25 psi

RAIL CAR IDENTIFICATION CHART

128 Non-pressure / low pressure tank car (TC117, DOT117)

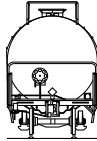
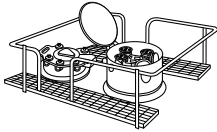

- For flammable liquids (e.g., Petroleum crude oil, ethanol)
- Protective housing separate from manway
- Bottom outlet valve
- Pressures usually below 25 psi

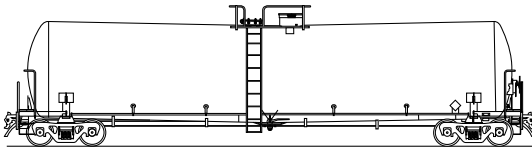

111 Box car

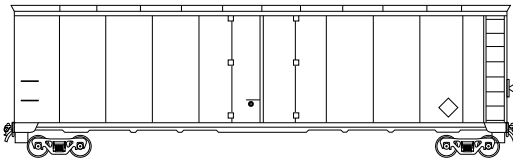

- For general freight that carry bulk or non-bulk packages
- May transport hazardous materials/dangerous goods in small packages or "tote bins"
- Single or double sliding door

140 Hopper car

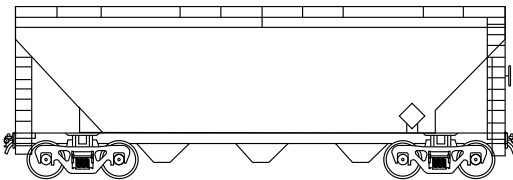

- For bulk commodities and bulk cargo (e.g., coal, ore, cement and solid granular materials)
- Bulk lading discharged by gravity through the hopper bottom doors when doors opened

COMMON MARKINGS ON RAIL CARS: reporting marks and car number, load limit (pounds or kilograms), empty weight of car, placard, tank qualification and pressure relief device information, car specification, and commodity name.

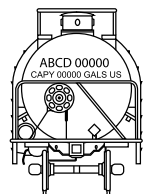
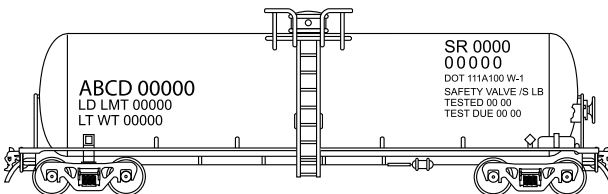

ROAD TRAILER IDENTIFICATION CHART

CAUTION: This chart depicts only the most general shapes of road trailers and cargo transport units. Emergency response personnel must be aware that there are many variations of road trailers, not illustrated below, that are used for shipping chemical products. Many intermodal tanks that transport liquids, solids, liquefied compressed gases, and refrigerated liquefied gases have similar silhouettes. The suggested guides are for the most hazardous products that may be transported in these trailer types.

WARNING: Road trailers may be jacketed, the cross-section may look different than shown and external ring stiffeners would be invisible.

NOTE: An emergency shut-off valve is commonly found at the front of the tank, near the driver door.

The recommended guides should be considered as last resort if the material cannot be identified by any other means.

MAWP: Maximum Allowable Working Pressure.

117 MC331, TC331, SCT331

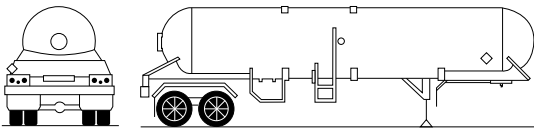

- For liquefied compressed gases (e.g., LPG, ammonia)
- Rounded heads
- Design pressure between 100-500 psi

117 MC338, TC338, SCT338, TC341, CGA341

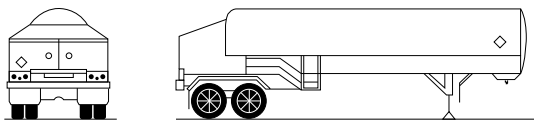

- For refrigerated liquefied gases (cryogenic liquids)
- Similar to a "giant thermo-bottle"
- Fitting compartments located in a cabinet at the rear of the tank
- MAWP between 25-500 psi

131 DOT406, TC406, SCT306, MC306, TC306

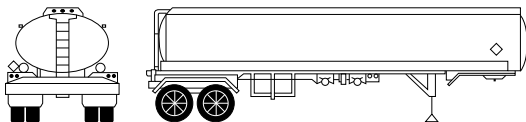

- For flammable liquids (e.g., gasoline, diesel)
- Elliptical cross-section
- Rollover protection at the top
- Bottom outlet valves
- MAWP between 3-15 psi

ROAD TRAILER IDENTIFICATION CHART

137 DOT407, TC407, SCT307, MC307, TC307

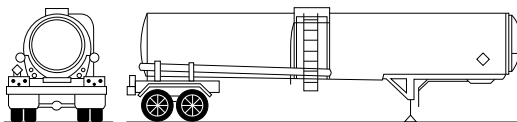

- For toxic, corrosive, and flammable liquids
- Circular cross-section
- May have external ring stiffeners
- MAWP of at least 25 psi

137 DOT412, TC412, SCT312, MC312, TC312

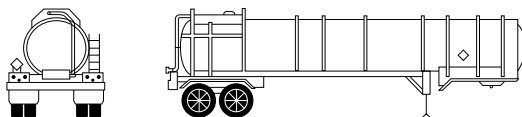

- Usually for corrosive liquids
- Circular cross-section
- External ring stiffeners
- Tank diameter is relatively small
- MAWP of at least 15 psi

112 TC423

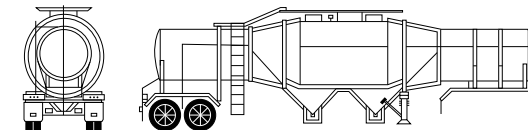

- For emulsion and water-gel explosives
- Hopper-style configuration
- MAWP between 5-15 psi

117 Compressed Gas/Tube Trailer

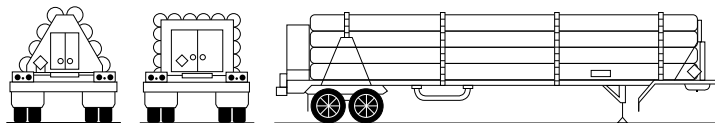

ROAD TRAILER IDENTIFICATION CHART

134 Dry Bulk Cargo Trailer

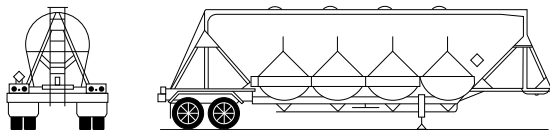

137 Vacuum Tanker

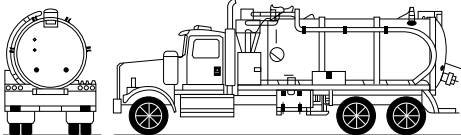

111 Mixed Cargo

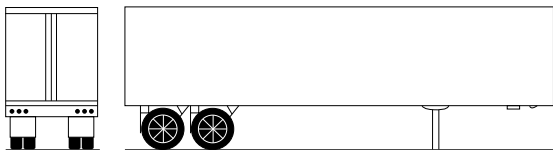

111 Intermodal Freight Container

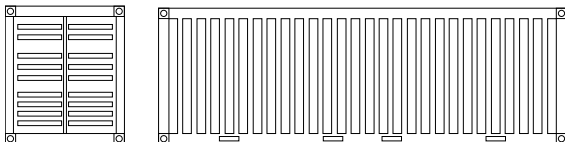

117 Intermodal Tank

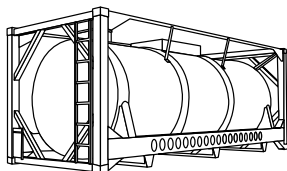

NOTES

GLOBALLY HARMONIZED SYSTEM OF CLASSIFICATION AND LABELING OF CHEMICALS (GHS)

(May be found on means of containment during transport)

The Globally Harmonized System of Classification and Labeling of Chemicals (GHS) is an international guideline published by the United Nations. The GHS aims to harmonize the classification and labeling systems for all sectors involved in the life cycle of a chemical (production, storage, transport, workplace use, consumer use and presence in the environment).

The GHS has nine symbols used to convey specific physical, health and environmental hazard information. These symbols are part of a pictogram that is diamond shaped and includes the GHS symbol in black on a white background with a red frame. The pictogram is part of the GHS label, which also includes the following information:

- **Signal word**
- **Hazard statement**
- **Precautionary statements**
- **Product identifier**
- **Supplier identification**

GHS pictograms are similar in shape to transport labels; however, transport labels have backgrounds of different colors.

The elements of the GHS that address signal words and hazard statements are not expected to be adopted in the transport sector. For substances and mixtures covered by the UN Recommendations on the Transport of Dangerous Goods, Model Regulations, the transport labels for physical hazards will have precedence. In transport, a GHS pictogram for the same (or lesser) hazard as the one reflected by the transport label or placard should not be present, but it could exist on the package.

Examples of GHS labeling:

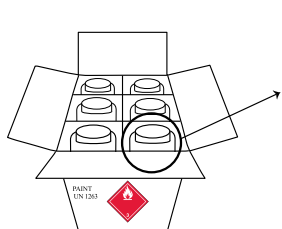

Outer Packaging: Box with flammable liquid transport label

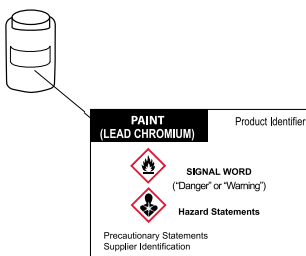



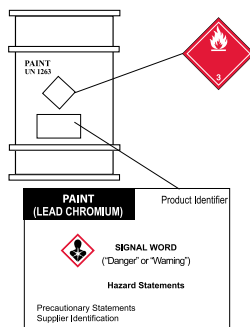







Inner Packaging: Plastic bottle with GHS hazard warning label



Single Packaging: 200 L (55 US gallons) drum with a flammable liquid transport label combined with GHS hazard warning label

In some cases, such as on drums or international bulk containers (IBCs), which must address information for all sectors, the GHS label may be found in addition to the required transport labels and placards. Both types of labels (GHS and transport) will differ in a way that will make them easy to identify during an emergency.

GHS Pictograms	Physical hazards	GHS Pictograms	Health and Environmental hazards
	Explosive; Self-reactive; Organic peroxide		Skin corrosion; Serious eye damage
	Flammable; Pyrophoric; Self-reactive; Organic peroxide; Self-heating; Emits flammable gases when in contact with water		Acute toxicity (harmful); Skin sensitizer; Irritant (skin and eye); Narcotic effect; Respiratory tract irritant; Hazardous to ozone layer (environment)
	Oxidizer		Respiratory sensitizer; Mutagen; Carcinogen; Reproductive toxicity; Target organ toxicity; Aspiration hazard
	Gas under pressure		Hazardous to aquatic environment
	Corrosive to metals		Acute toxicity (fatal or toxic)

HAZARD IDENTIFICATION NUMBERS DISPLAYED ON SOME INTERMODAL CONTAINERS

Hazard identification numbers, utilized under European and some South American regulations, may be found in the top half of an orange panel on some intermodal bulk containers. The 4-digit ID number is in the bottom half of the orange panel.



The hazard identification number in the top half of the orange panel consists of two or three digits. In general, the digits indicate the following hazards:

- 2 - Emission of gas due to pressure or chemical reaction
- 3 - Flammability of liquids (vapors) and gases or self-heating liquid
- 4 - Flammability of solids or self-heating solid
- 5 - Oxidizing (fire-intensifying) effect
- 6 - Toxicity or risk of infection
- 7 - Radioactivity
- 8 - Corrosivity
- 9 - Risk of spontaneous violent reaction

NOTE: The risk of spontaneous violent reaction within the meaning of digit 9 includes the possibility, due to the nature of a substance, of a risk of explosion, disintegration and polymerization reaction followed by the release of considerable heat or flammable and/or toxic gases.

- Doubling of a digit indicates an intensification of that particular hazard (i.e., 33, 66, 88).
- Where the hazard associated with a substance can be adequately indicated by a single digit, the digit is followed by a zero (i.e., 30, 40, 50).
- A hazard identification number prefixed by the letter "X" indicates that the substance will react dangerously with water (i.e., X88).

HAZARD IDENTIFICATION NUMBERS
DISPLAYED ON SOME INTERMODAL CONTAINERS

The hazard identification numbers listed below have the following meanings:

20	Asphyxiant gas or gas with no subsidiary hazard
22	Refrigerated liquefied gas, asphyxiant
223	Refrigerated liquefied gas, flammable
225	Refrigerated liquefied gas, oxidizing (fire-intensifying)
23	Flammable gas
238	Gas, flammable corrosive
239	Flammable gas which can spontaneously lead to violent reaction
25	Oxidizing (fire-intensifying) gas
26	Toxic gas
263	Toxic gas, flammable
265	Toxic gas, oxidizing (fire-intensifying)
268	Toxic gas, corrosive
28	Gas, corrosive
<hr/>	
30	Flammable liquid (flash-point between 23°C and 60°C, inclusive), or flammable liquid or solid in the molten state with a flash-point above 60°C, heated to a temperature equal to or above its flash point, or self-heating liquid
323	Flammable liquid which reacts with water, emitting flammable gases
X323	Flammable liquid which reacts dangerously with water, emitting flammable gases
33	Highly flammable liquid (flash-point below 23°C)
333	Pyrophoric liquid
X333	Pyrophoric liquid which reacts dangerously with water
336	Highly flammable liquid, toxic
338	Highly flammable liquid, corrosive
X338	Highly flammable liquid, corrosive, which reacts dangerously with water
339	Highly flammable liquid which can spontaneously lead to violent reaction
36	Flammable liquid (flash-point between 23°C and 60°C, inclusive), slightly toxic, or self-heating liquid, toxic
362	Flammable liquid, toxic, which reacts with water, emitting flammable gas
X362	Flammable liquid, toxic, which reacts dangerously with water, emitting flammable gases
368	Flammable liquid, toxic, corrosive
38	Flammable liquid (flash-point between 23°C and 60°C, inclusive), slightly corrosive or self-heating liquid, corrosive
382	Flammable liquid, corrosive, which reacts with water, emitting flammable gases
X382	Flammable liquid, corrosive, which reacts dangerously with water, emitting flammable gases
39	Flammable liquid, which can spontaneously lead to violent reaction
<hr/>	
40	Flammable solid, or self-reactive substance, or self-heating substance, or polymerizing substance

HAZARD IDENTIFICATION NUMBERS
DISPLAYED ON SOME INTERMODAL CONTAINERS

423	Solid which reacts with water, emitting flammable gases, or flammable solid which reacts with water, emitting flammable gases, or self-heating solid which reacts with water, emitting flammable gases
X423	Solid which reacts dangerously with water, emitting flammable gases, or flammable solid which reacts dangerously with water, emitting flammable gases, or self-heating solid which reacts dangerously with water, emitting flammable gases
43	Spontaneously flammable (pyrophoric) solid
X432	Spontaneously flammable (pyrophoric) solid which reacts dangerously with water, emitting flammable gases
44	Flammable solid, in the molten state at an elevated temperature
446	Flammable solid, toxic, in the molten state at an elevated temperature
46	Flammable or self-heating solid, toxic
462	Toxic solid which reacts with water, emitting flammable gases
X462	Solid which reacts dangerously with water, emitting toxic gases
48	Flammable or self-heating solid, corrosive
482	Corrosive solid which reacts with water, emitting flammable gases
X482	Solid which reacts dangerously with water, emitting corrosive gases
<hr/>	
50	Oxidizing (fire-intensifying) substance
539	Flammable organic peroxide
55	Strongly oxidizing (fire-intensifying) substance
556	Strongly oxidizing (fire-intensifying) substance, toxic
558	Strongly oxidizing (fire-intensifying) substance, corrosive
559	Strongly oxidizing (fire-intensifying) substance which can spontaneously lead to violent reaction
56	Oxidizing substance (fire-intensifying), toxic
568	Oxidizing substance (fire-intensifying), toxic, corrosive
58	Oxidizing substance (fire-intensifying), corrosive
59	Oxidizing substance (fire-intensifying), which can spontaneously lead to violent reaction
<hr/>	
60	Toxic or slightly toxic substance
606	Infectious substance
623	Toxic liquid, which reacts with water, emitting flammable gases
63	Toxic substance, flammable (flash-point between 23°C and 60°C, inclusive)
638	Toxic substance, flammable, (flash-point between 23°C and 60°C, inclusive), corrosive
639	Toxic substance, flammable, (flash-point not above 60°C) which can spontaneously lead to violent reaction
64	Toxic solid, flammable or self-heating
642	Toxic solid which reacts with water, emitting flammable gases
65	Toxic substance, oxidizing (fire-intensifying)
66	Highly toxic substance

HAZARD IDENTIFICATION NUMBERS
DISPLAYED ON SOME INTERMODAL CONTAINERS

663	Highly toxic substance, flammable (flash-point not above 60°C)
664	Highly toxic solid, flammable or self-heating
665	Highly toxic substance, oxidizing (fire-intensifying)
668	Highly toxic substance, corrosive
X668	Highly toxic substance, corrosive, which reacts dangerously with water
669	Highly toxic substance which can spontaneously lead to violent reaction
68	Toxic substance, corrosive
69	Toxic or slightly toxic substance which can spontaneously lead to violent reaction
<hr/>	
70	Radioactive material
768	Radioactive material, toxic, corrosive
78	Radioactive material, corrosive
<hr/>	
80	Corrosive or slightly corrosive substance
X80	Corrosive or slightly corrosive substance which reacts dangerously with water
823	Corrosive liquid which reacts with water, emitting flammable gases
83	Corrosive or slightly corrosive substance, flammable (flash-point between 23°C and 60°C, inclusive)
X83	Corrosive or slightly corrosive substance, flammable (flash-point between 23°C and 60°C, inclusive), which reacts dangerously with water
839	Corrosive or slightly corrosive substance, flammable (flash-point between 23°C and 60°C, inclusive), which can spontaneously lead to violent reaction
X839	Corrosive or slightly corrosive substance, flammable (flash-point between 23°C and 60°C, inclusive), which can spontaneously lead to violent reaction and which reacts dangerously with water
84	Corrosive solid, flammable or self-heating
842	Corrosive solid which reacts with water, emitting flammable gases
85	Corrosive or slightly corrosive substance, oxidizing (fire-intensifying)
856	Corrosive or slightly corrosive substance, oxidizing (fire-intensifying) and toxic
86	Corrosive or slightly corrosive substance, toxic
88	Highly corrosive substance
X88	Highly corrosive substance which reacts dangerously with water
883	Highly corrosive substance, flammable (flash-point between 23°C and 60°C, inclusive)
884	Highly corrosive solid, flammable or self-heating
885	Highly corrosive substance, oxidizing (fire-intensifying)
886	Highly corrosive substance, toxic
X886	Highly corrosive substance, toxic, which reacts dangerously with water
89	Corrosive or slightly corrosive substance which can spontaneously lead to violent reaction
<hr/>	
90	Environmentally hazardous substance; miscellaneous dangerous substances
99	Miscellaneous dangerous substance carried at an elevated temperature

PIPELINE TRANSPORTATION

In North America, hazardous materials/dangerous goods are commonly transported through millions of miles of pipelines and related structures. Products transported include natural gas, natural gas liquids, crude oil, gasoline, diesel fuel, anhydrous ammonia, carbon dioxide, jet fuel, and other commodities. Although most pipelines are buried, often there are aboveground structures and markers indicating the presence of pipelines. First responders should be aware of the pipelines in their jurisdictions, the products they transport, and the operators responsible for those pipelines. Proactive relationships can be beneficial in the safe and effective management of pipeline emergencies.

Types of Pipelines

Natural Gas Pipelines

Natural Gas Transmission Pipelines

Large-diameter, steel pipelines transport flammable natural gas (toxic and non-toxic) at very high pressures ranging from 200 to 1,500 psi*. Natural gas in transmission pipelines is odorless — generally *not odorized* with mercaptan (the “rotten egg” smell); however, natural gas containing hydrogen sulfide (H₂S) will have a distinct “rotten egg” odor.

Natural Gas Distribution Pipelines

Natural gas is delivered directly to customers via distribution pipelines. These pipelines are typically smaller-diameter, lower-pressure pipelines constructed of steel, plastic, or cast iron. Natural gas in distribution pipelines *is odorized* with mercaptan (the “rotten egg” smell).

Natural Gas-Gathering and Natural Gas Well Production Pipelines

Natural gas-gathering/well production pipelines collect “raw” natural gas from wellheads and transport the product to gas-processing and/or gas-treating plants. These gathering pipelines carry natural gas mixed with some quantity of natural gas liquids, water, and, in some areas, contaminants such as toxic hydrogen sulfide (H₂S). Natural gas in these pipelines is *not odorized* with mercaptan (the “rotten egg” smell); however, natural gas that contains hydrogen sulfide (H₂S) will have a distinct “rotten egg” odor.

Hazardous Liquid and Highly Volatile Liquid Pipelines

Hazardous Liquid Pipelines

Crude oil, refined petroleum products (e.g. gasoline, kerosene, jet fuel or diesel) and hazardous liquids (e.g. anhydrous ammonia or ethanol) are often transported by pipelines.

Many liquid petroleum pipelines transport different types of liquid petroleum in the same pipeline. To do so, the pipeline operator sends different products in “batches.” For example, an operator could send gasoline for several hours, and then switch to jet fuels, before switching to diesel fuel.

*Data from <http://naturalgas.org/naturalgas/transport/>

Highly Volatile Liquid (HVL) Pipelines

HVL pipelines transport hazardous liquids which will form a vapor cloud when released to the atmosphere and which have a vapor pressure exceeding 276 KPa (40 psia) at 37.8°C (100°F). An example of an HVL is liquid propane.

Pipeline Markers

Since pipelines are usually buried underground, pipeline markers are used to indicate their presence in an area along the pipeline route. Of the three types of pipelines typically buried underground — distribution, gathering, and transmission — only transmission pipelines are marked with the following above-ground markers used to indicate their route.



Markers warn that a transmission pipeline is located in the area, identify the product transported in the line, and provide the name and telephone number of the pipeline operator to call. Markers and warning signs are located at frequent intervals along natural gas and liquid transmission pipeline rights-of-way, and are located at prominent points such as where pipelines intersect streets, highways, railways, or waterways.

Pipeline markers only indicate the presence of a pipeline—they do not indicate the exact location of the pipeline. Pipeline locations within a right-of-way may vary along its length and there may be multiple pipelines located in the same right-of-way.

NOTE:

- Markers for pipelines transporting materials containing dangerous levels of hydrogen sulfide (H₂S) may have markers that say: “Sour” or “Poison.”
- Natural gas distribution pipelines are not marked with above-ground signs.
- Gathering/production pipelines are often not marked with above-ground signs.

Pipeline Structures (Above Ground)

Natural Gas Transmission Pipelines:	Compressor stations, valves, metering stations.
Natural Gas Distribution Pipelines:	Regulator stations, customer meters and regulators, valve box covers.
Natural Gas Gathering/Well Production Pipelines:	Compressor stations, valves, metering stations, wellheads, piping, manifolds.
Petroleum and Hazardous Liquids Pipelines:	Storage tanks, valves, pump stations, loading racks.

Indications of Pipeline Leaks and Ruptures

Pipeline releases can range from relatively minor leaks to catastrophic ruptures. It is important to remember that gases and liquids behave differently once they are released from a pipeline. Generally, the following could be indications of a pipeline leak or rupture:

- Hissing, roaring, or explosive sound
- Flames appearing from the ground or water (perhaps very large flames)
- Vapor cloud/fog/mist
- Dirt/debris/water blowing out of the ground
- Liquids bubbling up from the ground or bubbling in water
- Distinctive, unusually strong odor of rotten eggs, mercaptan (an odorant in some natural gas pipelines), skunk, or petroleum
- Discolored/dead vegetation or discolored snow above a pipeline right-of-way
- Oil slick or sheen on flowing/standing water
- An area of frozen ground in the summer
- An unusual area of melted snow in the winter

General Considerations for Responding to a Pipeline Emergency

- **Safety First!** Your safety and the safety of the community you protect is top priority. Remember to approach a pipeline incident from upwind, uphill, and upstream while using air monitoring equipment to detect for the presence of explosive and/or toxic levels of hazardous materials/dangerous goods.
 - Always wear proper personal protective equipment. Be prepared for a flash fire. Use shielding to protect first responders in the event of an explosion. Use respiratory protection.
 - Never operate pipeline valves (except in coordination with the pipeline operator); this could make the incident worse and put you and others in danger.
 - Never attempt to extinguish a pipeline fire before supply is shut off; this could result in the accumulation of a large flammable/explosive vapor cloud or liquid pool that could make the incident worse and put you and others in danger.
 - Do not walk or drive into a vapor cloud in an attempt to identify the product(s) involved.
 - Do not park over manholes or storm drains.
 - Do not approach the scene with vehicles or mechanical equipment until the isolation zones have been established (vehicles are a potential ignition source).
- **Secure the site** and determine a plan to evacuate or shelter-in-place. Work with other responders to deny entry to an area.
- **Identify the product and the operator.** If safe to do so, you may be able to identify the product based on its characteristics or other external clues. Look for pipeline markers indicating the product, operator of the pipeline, and their emergency contact information. Pipelines transport many different types of products, including gases, liquids, and highly volatile liquids that are in a liquid state inside the pipeline but in a gaseous state if released from the pipeline. The vapor density of gases determines if they rise or sink in air. Viscosity and specific gravity also are important characteristics of hazardous liquids to consider. Identification of the product also will help you determine the appropriate distance for isolation of the affected area.
- **Notify the pipeline operator** using the emergency contact information on the pipeline marker or other contact information you may have received from the pipeline operator. The pipeline operator will be a resource to you in the response.
- **Establish a command post.** Implement the Incident Command Structure, as needed, and be prepared to implement a Unified Command as additional stakeholders and resources arrive.

Other Important Considerations

- If no flames are present, do not introduce ignition sources such as open flames, running vehicles, or electrical equipment (cell phones, pagers, two-way radios, lights, garage door openers, fans, door bells, etc.).
- Abandon any equipment used in or near the area of the pipeline release.
- If there is no risk to your safety or the safety of others, move far enough away from any noise coming from the pipeline to allow for normal conversation.
- Pipelines often are close to other public utilities, railroads, and highways; these can be impacted by pipeline releases or may be potential ignition sources.
- Natural gas can migrate underground from the source of a release to other areas via the path of least resistance (including through sewers, water lines, and geologic formations).

Considerations for Establishing Protective Action Distances

- Type of product
 - If you know the material involved, identify the three-digit guide number by looking up the name in the alphabetical list (blue-bordered pages), then using the three-digit guide number, consult the recommendations in the assigned guide.
- Pressure and diameter of pipe (the pipeline operator can tell you this if you don't already know it)
- Timing of valve closure by the pipeline operator (quickly for automated valves; longer for manually operated valves)
- Dissipation time of the product in the pipeline once valves are closed
- Ability to conduct atmospheric monitoring and/or air sampling
- Weather (wind direction, etc.)
- Local variables such as topography, population density, demographics, and fire suppression methods available
- Nearby building construction material/density
- Natural and man-made barriers (such as highways, railroads, rivers, etc.)

U.S. Pipeline Resources

U.S. Pipeline Locations: The National Pipeline Mapping System (NPMS) <http://www.npms.phmsa.dot.gov> indicates the general locations of hazardous liquids and natural gas transmission pipelines found within the U.S. The pipelines depicted in the NPMS are within 500 feet of their actual locations. Emergency responders may apply for an NPMS web viewer account that will allow access to more detailed information than is available to the general public. The NPMS does not contain gathering/production or natural gas distribution pipelines.

U.S. Pipeline Emergency Response Training: Where appropriate, reference pipeline emergencies training materials produced by the Pipeline and Hazardous Materials Safety Administration. Your state or jurisdiction also may provide training on how to handle the response to a pipeline incident.

Other Resources:

Pipeline Association for Public Awareness

<http://www.pipelineawareness.org/>

U.S. DOT, Pipeline and Hazardous Materials Safety Administration

<https://www.phmsa.dot.gov/safety-awareness/pipeline/safety-awareness-overview>

Pipeline Emergency Responders Initiative (PERI)

<https://www.phmsa.dot.gov/pipeline/peri/pipeline-emergency-responders-initiative-peri>

Canadian Pipeline Resources

Canadian Pipeline Locations: The Canadian Energy Pipeline Association (CEPA) provides the general locations of natural gas and liquid pipelines found within Canada.

<https://www.cepa.com>

INTRODUCTION TO YELLOW PAGES

For entries **highlighted in green** follow these steps:

- **IF THERE IS NO FIRE:**

- Go directly to **Table 1** (**green-bordered pages**)
- Look up the ID number and name of material
- Identify initial isolation and protective action distances
- Also consult the appropriate Orange Guide

- **IF A FIRE IS INVOLVED:**

- Use the appropriate Orange Guide for **EVACUATION** distances
- Also protect in downwind direction according to Table 1 for residual material release

Note 1: If the name in **Table 1** is shown with **(when spilled in water)**, these materials produce large amounts of Toxic Inhalation Hazard (TIH) (PIH in the US) gases when spilled in water. Some Water Reactive materials are also TIH materials themselves (e.g., UN1746 (Bromine trifluoride), UN1836 (Thionyl chloride)). In these instances, two entries are provided in **Table 1** for land-based and water-based spills. If a water-reactive material only has one entry in Table 1 for **(when spilled in water)** and the product is NOT spilled in water, Table 1 and Table 2 do not apply. You will find safe distances in the appropriate orange-bordered guide.

Note 2: Explosives are not individually listed by their ID number because in an emergency situation, the response will be based only on the division of the explosive, not on the individual explosive.

For divisions 1.1, 1.2, 1.3 and 1.5, refer to GUIDE 112.

For divisions 1.4 and 1.6, refer to GUIDE 114.

Note 3: Chemical warfare agents do not have an assigned ID number because they are not commercially transported. In an emergency situation, the assigned orange guide will provide guidance for the initial response. Also consult "Criminal or Terrorist Use of Chemical, Biological and Radiological Agents", pp. 368 to 372.

ID Guide Name of Material
No. No.

---	117	AC
---	154	Adamsite
---	112	Ammonium nitrate-fuel oil mixtures
---	158	Biological agents
---	112	Blasting agent, n.o.s.
---	153	Buzz
---	153	BZ
---	159	CA
---	125	CG
---	125	CK
---	153	CN
---	153	CS
---	154	CX
---	151	DA
---	153	DC
---	154	DM
---	125	DP
---	151	ED
---	112	Explosives, division 1.1, 1.2, 1.3 or 1.5
---	114	Explosives, division 1.4 or 1.6
---	153	GA
---	153	GB
---	153	GD
---	153	GF
---	153	H
---	153	HD
---	153	HL
---	153	HN-1
---	153	HN-2
---	153	HN-3

ID Guide Name of Material
No. No.

---	153	L (Lewisite)
---	153	Lewisite
---	152	MD
---	153	Mustard
---	153	Mustard Lewisite
---	152	PD
---	119	SA
---	153	Sarin
---	153	Soman
---	153	Tabun
---	153	Thickened GD
---	153	Toxins
---	153	VX
1001	116	Acetylene, dissolved
1002	122	Air, compressed
1003	122	Air, refrigerated liquid (cryogenic liquid)
1005	125	Ammonia, anhydrous
1005	125	Anhydrous ammonia
1006	120	Argon
1006	120	Argon, compressed
1008	125	Boron trifluoride
1008	125	Boron trifluoride, compressed
1009	126	Bromotrifluoromethane
1009	126	Refrigerant gas R-13B1
1010	116P	Butadienes, stabilized
1010	116P	Butadienes and hydrocarbon mixture, stabilized
1010	116P	Hydrocarbon and butadienes mixture, stabilized
1011	115	Butane
1012	115	Butylene

ID Guide Name of Material
No. No.

1013	120	Carbon dioxide
1013	120	Carbon dioxide, compressed
1014	122	Carbon dioxide and Oxygen mixture, compressed
1014	122	Oxygen and Carbon dioxide mixture, compressed
1015	126	Carbon dioxide and Nitrous oxide mixture
1015	126	Nitrous oxide and Carbon dioxide mixture
1016	119	Carbon monoxide
1016	119	Carbon monoxide, compressed
1017	124	Chlorine
1018	126	Chlorodifluoromethane
1018	126	Refrigerant gas R-22
1020	126	Chloropentafluoroethane
1020	126	Refrigerant gas R-115
1021	126	1-Chloro-1,2,2,2-tetrafluoroethane
1021	126	Refrigerant gas R-124
1022	126	Chlorotrifluoromethane
1022	126	Refrigerant gas R-13
1023	119	Coal gas
1023	119	Coal gas, compressed
1026	119	Cyanogen
1027	115	Cyclopropane
1028	126	Dichlorodifluoromethane
1028	126	Refrigerant gas R-12
1029	126	Dichlorofluoromethane
1029	126	Refrigerant gas R-21
1030	115	1,1-Difluoroethane
1030	115	Refrigerant gas R-152a
1032	118	Dimethylamine, anhydrous

ID Guide Name of Material
No. No.

1033	115	Dimethyl ether
1035	115	Ethane
1035	115	Ethane, compressed
1036	118	Ethylamine
1037	115	Ethyl chloride
1038	115	Ethylene, refrigerated liquid (cryogenic liquid)
1039	115	Ethyl methyl ether
1039	115	Methyl ethyl ether
1040	119P	Ethylene oxide
1040	119P	Ethylene oxide with Nitrogen
1041	115	Carbon dioxide and Ethylene oxide mixture, with more than 9% but not more than 87% Ethylene oxide
1041	115	Ethylene oxide and Carbon dioxide mixture, with more than 9% but not more than 87% Ethylene oxide
1043	125	Fertilizer, ammoniating solution, with free Ammonia
1044	126	Fire extinguishers with compressed or liquefied gas
1045	124	Fluorine
1045	124	Fluorine, compressed
1046	120	Helium
1046	120	Helium, compressed
1048	125	Hydrogen bromide, anhydrous
1049	115	Hydrogen
1049	115	Hydrogen, compressed
1050	125	Hydrogen chloride, anhydrous
1051	117P	Hydrogen cyanide, anhydrous, stabilized
1051	117P	Hydrogen cyanide, stabilized
1052	125	Hydrogen fluoride, anhydrous

**ID Guide Name of Material
No. No.**

1053	117	Hydrogen sulfide
1053	117	Hydrogen sulphide
1055	115	Isobutylene
1056	120	Krypton
1056	120	Krypton, compressed
1057	115	Lighter refills containing flammable gas
1057	115	Lighters containing flammable gas
1057	128	Lighters, non-pressurized, containing flammable liquid
1058	120	Liquefied gases, non-flammable, charged with Nitrogen, Carbon dioxide or Air
1060	116P	Methylacetylene and Propadiene mixture, stabilized
1060	116P	Propadiene and Methylacetylene mixture, stabilized
1061	118	Methylamine, anhydrous
1062	123	Methyl bromide
1063	115	Methyl chloride
1063	115	Refrigerant gas R-40
1064	117	Methyl mercaptan
1065	120	Neon
1065	120	Neon, compressed
1066	120	Nitrogen
1066	120	Nitrogen, compressed
1067	124	Dinitrogen tetroxide
1067	124	Nitrogen dioxide
1069	125	Nitrosyl chloride
1070	122	Nitrous oxide
1070	122	Nitrous oxide, compressed

**ID Guide Name of Material
No. No.**

1071	119	Oil gas
1071	119	Oil gas, compressed
1072	122	Oxygen
1072	122	Oxygen, compressed
1073	122	Oxygen, refrigerated liquid (cryogenic liquid)
1075	115	Butane
1075	115	Butylene
1075	115	Isobutane
1075	115	Isobutylene
1075	115	Liquefied petroleum gas
1075	115	LPG
1075	115	Petroleum gases, liquefied
1075	115	Propane
1075	115	Propylene
1076	125	Phosgene
1077	115	Propylene
1078	126	Dispersant gas, n.o.s.
1078	126	Refrigerant gas, n.o.s.
1079	125	Sulfur dioxide
1079	125	Sulphur dioxide
1080	126	Sulfur hexafluoride
1080	126	Sulphur hexafluoride
1081	116P	Tetrafluoroethylene, stabilized
1082	119P	Refrigerant gas R-1113
1082	119P	Trifluorochloroethylene, stabilized
1083	118	Trimethylamine, anhydrous
1085	116P	Vinyl bromide, stabilized
1086	116P	Vinyl chloride, stabilized
1087	116P	Vinyl methyl ether, stabilized
1088	127	Acetal

**ID Guide Name of Material
No. No.**

1089 **129P** Acetaldehyde
1090 **127** Acetone
1091 **127** Acetone oils
1092 **131P** Acrolein, stabilized
1093 **131P** Acrylonitrile, stabilized
1098 **131** Allyl alcohol
1099 **131P** Allyl bromide
1100 **131P** Allyl chloride
1104 **129** Amyl acetates
1105 **129** Pentanols
1106 **132** Amylamine
1107 **129** Amyl chloride
1108 **128** n-Amylene
1108 **128** 1-Pentene
1109 **129** Amyl formates
1110 **127** n-Amyl methyl ketone
1110 **127** Methyl amyl ketone
1111 **130** Amyl mercaptan
1112 **128** Amyl nitrate
1113 **129** Amyl nitrite
1114 **130** Benzene
1120 **129** Butanols
1123 **129** Butyl acetates
1125 **132** n-Butylamine
1126 **130** 1-Bromobutane
1126 **130** n-Butyl bromide
1127 **130** n-Butyl chloride
1127 **130** Chlorobutanes
1128 **129** n-Butyl formate
1129 **129P** Butyraldehyde
1130 **128** Camphor oil

**ID Guide Name of Material
No. No.**

1131 **131** Carbon bisulfide
1131 **131** Carbon bisulphide
1131 **131** Carbon disulfide
1131 **131** Carbon disulphide
1133 **128** Adhesives (flammable)
1134 **130** Chlorobenzene
1135 **131** Ethylene chlorohydrin
1136 **128** Coal tar distillates, flammable
1139 **127** Coating solution
1143 **131P** Crotonaldehyde
1143 **131P** Crotonaldehyde, stabilized
1144 **128** Crotonylene
1145 **128** Cyclohexane
1146 **128** Cyclopentane
1147 **130** Decahydronaphthalene
1148 **129** Diacetone alcohol
1149 **128** Butyl ethers
1149 **128** Dibutyl ethers
1150 **130P** 1,2-Dichloroethylene
1152 **130** Dichloropentanes
1153 **127** Ethylene glycol diethyl ether
1154 **132** Diethylamine
1155 **127** Diethyl ether
1155 **127** Ethyl ether
1156 **127** Diethyl ketone
1157 **128** Diisobutyl ketone
1158 **132** Diisopropylamine
1159 **127** Diisopropyl ether
1160 **132** Dimethylamine, aqueous solution
1160 **132** Dimethylamine, solution
1161 **129** Dimethyl carbonate

ID Guide Name of Material
No. No.

1162	155	Dimethyldichlorosilane
1163	131	Dimethylhydrazine, unsymmetrical
1164	130	Dimethyl sulfide
1164	130	Dimethyl sulphide
1165	127	Dioxane
1166	127	Dioxolane
1167	128P	Divinyl ether, stabilized
1169	127	Extracts, aromatic, liquid
1170	127	Ethanol
1170	127	Ethanol, solution
1170	127	Ethyl alcohol
1170	127	Ethyl alcohol, solution
1171	127	Ethylene glycol monoethyl ether
1172	129	Ethylene glycol monoethyl ether acetate
1173	129	Ethyl acetate
1175	130	Ethylbenzene
1176	129	Ethyl borate
1177	130	2-Ethylbutyl acetate
1178	130	2-Ethylbutyraldehyde
1179	127	Ethyl butyl ether
1180	130	Ethyl butyrate
1181	155	Ethyl chloroacetate
1182	155	Ethyl chloroformate
1183	139	Ethyldichlorosilane
1184	131	Ethylene dichloride
1185	131P	Ethyleneimine, stabilized
1188	127	Ethylene glycol monomethyl ether
1189	129	Ethylene glycol monomethyl ether acetate
1190	129	Ethyl formate

ID Guide Name of Material
No. No.

1191	129	Ethylhexaldehydes
1191	129	Octyl aldehydes
1192	129	Ethyl lactate
1193	127	Ethyl methyl ketone
1193	127	Methyl ethyl ketone
1194	131	Ethyl nitrite, solution
1195	129	Ethyl propionate
1196	155	Ethyltrichlorosilane
1197	127	Extracts, flavoring, liquid
1197	127	Extracts, flavouring, liquid
1198	132	Formaldehyde, solution, flammable
1198	132	Formalin (flammable)
1199	153P	Furaldehydes
1201	127	Fusel oil
1202	128	Diesel fuel
1202	128	Fuel oil
1202	128	Gas oil
1202	128	Heating oil, light
1203	128	Gasohol
1203	128	Gasoline
1203	128	Motor spirit
1203	128	Petrol
1204	127	Nitroglycerin, solution in alcohol, with not more than 1% Nitroglycerin
1206	128	Heptanes
1207	130	Hexaldehyde
1208	128	Hexanes
1208	128	Neohexane
1210	129	Ink, printer's, flammable
1210	129	Printing ink, flammable

**ID Guide Name of Material
No. No.**

1210	129	Printing ink related material, flammable
1212	129	Isobutanol
1212	129	Isobutyl alcohol
1213	129	Isobutyl acetate
1214	132	Isobutylamine
1216	128	Isooctenes
1218	130P	Isoprene, stabilized
1219	129	Isopropanol
1219	129	Isopropyl alcohol
1220	129	Isopropyl acetate
1221	132	Isopropylamine
1222	130	Isopropyl nitrate
1223	128	Kerosene
1224	127	Ketones, liquid, n.o.s.
1228	131	Mercaptan mixture, liquid, flammable, poisonous, n.o.s.
1228	131	Mercaptan mixture, liquid, flammable, toxic, n.o.s.
1228	131	Mercaptans, liquid, flammable, poisonous, n.o.s.
1228	131	Mercaptans, liquid, flammable, toxic, n.o.s.
1229	129	Mesityl oxide
1230	131	Methanol
1230	131	Methyl alcohol
1231	129	Methyl acetate
1233	130	Methylamyl acetate
1234	127	Methylal
1235	132	Methylamine, aqueous solution
1237	129	Methyl butyrate
1238	155	Methyl chloroformate
1239	131	Methyl chloromethyl ether

**ID Guide Name of Material
No. No.**

1242	139	Methyldichlorosilane
1243	129	Methyl formate
1244	131	Methylhydrazine
1245	127	Methyl isobutyl ketone
1246	127P	Methyl isopropenyl ketone, stabilized
1247	129P	Methyl methacrylate monomer, stabilized
1248	129	Methyl propionate
1249	127	Methyl propyl ketone
1250	155	Methyltrichlorosilane
1251	131P	Methyl vinyl ketone, stabilized
1259	131	Nickel carbonyl
1261	129	Nitromethane
1262	128	Isooctane
1262	128	Octanes
1263	128	Paint (flammable)
1263	128	Paint related material (flammable)
1264	129	Paraldehyde
1265	128	Isopentane
1265	128	Pentanes
1266	127	Perfumery products, with flammable solvents
1267	128	Petroleum crude oil
1268	128	Petroleum distillates, n.o.s.
1268	128	Petroleum products, n.o.s.
1270	128	Oil, petroleum
1270	128	Petroleum oil
1272	129	Pine oil
1274	129	n-Propanol
1274	129	Propyl alcohol, normal
1275	129P	Propionaldehyde

**ID Guide Name of Material
No. No.**

1276	129	n-Propyl acetate
1277	132	Propylamine
1278	129	1-Chloropropane
1278	129	Propyl chloride
1279	130	1,2-Dichloropropane
1280	127P	Propylene oxide
1281	129	Propyl formates
1282	129	Pyridine
1286	127	Rosin oil
1287	127	Rubber solution
1288	128	Shale oil
1289	132	Sodium methylate, solution in alcohol
1292	129	Ethyl silicate
1292	129	Tetraethyl silicate
1293	127	Tinctures, medicinal
1294	130	Toluene
1295	139	Trichlorosilane
1296	132	Triethylamine
1297	132	Trimethylamine, aqueous solution
1298	155	Trimethylchlorosilane
1299	128	Turpentine
1300	128	Turpentine substitute
1301	129P	Vinyl acetate, stabilized
1302	127P	Vinyl ethyl ether, stabilized
1303	130P	Vinylidene chloride, stabilized
1304	127P	Vinyl isobutyl ether, stabilized
1305	155P	Vinyltrichlorosilane
1305	155P	Vinyltrichlorosilane, stabilized
1306	129	Wood preservatives, liquid
1307	130	Xylenes

**ID Guide Name of Material
No. No.**

1308	170	Zirconium suspended in a flammable liquid
1308	170	Zirconium suspended in a liquid (flammable)
1309	170	Aluminum powder, coated
1310	113	Ammonium picrate, wetted with not less than 10% water
1312	133	Borneol
1313	133	Calcium resinate
1314	133	Calcium resinate, fused
1318	133	Cobalt resinate, precipitated
1320	113	Dinitrophenol, wetted with not less than 15% water
1321	113	Dinitrophenolates, wetted with not less than 15% water
1322	113	Dinitroresorcinol, wetted with not less than 15% water
1323	170	Ferrocium
1324	133	Films, nitrocellulose base
1325	133	Flammable solid, organic, n.o.s.
1325	133	Fusee (railway or highway)
1326	170	Hafnium powder, wetted with not less than 25% water
1327	133	Bhusa, wet, damp or contaminated with oil
1327	133	Hay, wet, damp or contaminated with oil
1327	133	Straw, wet, damp or contaminated with oil
1328	133	Hexamethylenetetramine
1330	133	Manganese resinate
1331	133	Matches, "strike anywhere"
1332	133	Metaldehyde
1333	170	Cerium, slabs, ingots or rods
1334	133	Naphthalene, crude

ID Guide No. No. Name of Material

ID Guide No. No. Name of Material

1334 **133** Naphthalene, refined

1336 **113** Nitroguanidine, wetted with not less than 20% water

1336 **113** Picrite, wetted with not less than 20% water

1337 **113** Nitrostarch, wetted with not less than 20% water

1338 **133** Phosphorus, amorphous

1338 **133** Red phosphorus

1339 **139** Phosphorus heptasulfide, free from yellow and white Phosphorus

1339 **139** Phosphorus heptasulphide, free from yellow and white Phosphorus

1340 **139** Phosphorus pentasulfide, free from yellow and white Phosphorus

1340 **139** Phosphorus pentasulphide, free from yellow and white Phosphorus

1341 **139** Phosphorus sesquisulfide, free from yellow and white Phosphorus

1341 **139** Phosphorus sesquisulphide, free from yellow and white Phosphorus

1343 **139** Phosphorus trisulfide, free from yellow and white Phosphorus

1343 **139** Phosphorus trisulphide, free from yellow and white Phosphorus

1344 **113** Picric acid, wetted with not less than 30% water

1344 **113** Trinitrophenol, wetted with not less than 30% water

1345 **133** Rubber scrap, powdered or granulated

1345 **133** Rubber shoddy, powdered or granulated

1346 **170** Silicon powder, amorphous

1347 **113** Silver picrate, wetted with not less than 30% water

1348 **113** Sodium dinitro-o-cresolate, wetted with not less than 15% water

1349 **113** Sodium picramate, wetted with not less than 20% water

1350 **133** Sulfur

1350 **133** Sulphur

1352 **170** Titanium powder, wetted with not less than 25% water

1353 **133** Fabrics impregnated with weakly nitrated Nitrocellulose, n.o.s.

1353 **133** Fibers impregnated with weakly nitrated Nitrocellulose, n.o.s.

1353 **133** Fibres impregnated with weakly nitrated Nitrocellulose, n.o.s.

1354 **113** Trinitrobenzene, wetted with not less than 30% water

1355 **113** Trinitrobenzoic acid, wetted with not less than 30% water

1356 **113** TNT, wetted with not less than 30% water

1356 **113** Trinitrotoluene, wetted with not less than 30% water

1357 **113** Urea nitrate, wetted with not less than 20% water

1358 **170** Zirconium powder, wetted with not less than 25% water

1360 **139** Calcium phosphide

1361 **133** Carbon, animal or vegetable origin

1361 **133** Charcoal

1362 **133** Carbon, activated

1363 **135** Copra

1364 **133** Cotton waste, oily

ID Guide Name of Material
No. No.

1365	133	Cotton
1365	133	Cotton, wet
1366	135	Diethylzinc
1369	135	p-Nitrosodimethylaniline
1370	135	Dimethylzinc
1372	133	Fibers, animal or vegetable, burnt, wet or damp
1372	133	Fibres, animal or vegetable, burnt, wet or damp
1373	133	Fabrics, animal or vegetable or synthetic, n.o.s. with oil
1373	133	Fibers, animal or vegetable or synthetic, n.o.s. with oil
1373	133	Fibres, animal or vegetable or synthetic, n.o.s. with oil
1374	133	Fish meal, unstabilized
1374	133	Fish scrap, unstabilized
1376	135	Iron oxide, spent
1376	135	Iron sponge, spent
1378	170	Metal catalyst, wetted
1379	133	Paper, unsaturated oil treated
1380	135	Pentaborane
1381	136	Phosphorus, white, dry or under water or in solution
1381	136	Phosphorus, yellow, dry or under water or in solution
1381	136	White phosphorus, dry or under water or in solution
1381	136	Yellow phosphorus, dry or under water or in solution
1382	135	Potassium sulfide, anhydrous
1382	135	Potassium sulfide, with less than 30% water of crystallization
1382	135	Potassium sulphide, anhydrous

ID Guide Name of Material
No. No.

1382	135	Potassium sulphide, with less than 30% water of crystallization
1383	135	Aluminum powder, pyrophoric
1383	135	Pyrophoric alloy, n.o.s.
1383	135	Pyrophoric metal, n.o.s.
1384	135	Sodium dithionite
1384	135	Sodium hydrosulfite
1384	135	Sodium hydrosulphite
1385	135	Sodium sulfide, anhydrous
1385	135	Sodium sulfide, with less than 30% water of crystallization
1385	135	Sodium sulphide, anhydrous
1385	135	Sodium sulphide, with less than 30% water of crystallization
1386	135	Seed cake, with more than 1.5% oil and not more than 11% moisture
1387	133	Wool waste, wet
1389	138	Alkali metal amalgam, liquid
1390	139	Alkali metal amides
1391	138	Alkali metal dispersion
1391	138	Alkaline earth metal dispersion
1392	138	Alkaline earth metal amalgam, liquid
1393	138	Alkaline earth metal alloy, n.o.s.
1394	138	Aluminum carbide
1395	139	Aluminum ferrosilicon powder
1396	138	Aluminum powder, uncoated
1397	139	Aluminum phosphide
1398	138	Aluminum silicon powder, uncoated
1400	138	Barium
1401	138	Calcium

**ID Guide Name of Material
No. No.**

1402	138	Calcium carbide
1403	138	Calcium cyanamide, with more than 0.1% Calcium carbide
1404	138	Calcium hydride
1405	138	Calcium silicide
1407	138	Caesium
1407	138	Cesium
1408	139	Ferrosilicon
1409	138	Metal hydrides, water-reactive, n.o.s.
1410	138	Lithium aluminum hydride
1411	138	Lithium aluminum hydride, ethereal
1413	138	Lithium borohydride
1414	138	Lithium hydride
1415	138	Lithium
1417	138	Lithium silicon
1418	138	Magnesium alloys powder
1418	138	Magnesium powder
1419	139	Magnesium aluminum phosphide
1420	138	Potassium, metal alloys, liquid
1421	138	Alkali metal alloy, liquid, n.o.s.
1422	138	Potassium sodium alloys, liquid
1422	138	Sodium potassium alloys, liquid
1423	138	Rubidium
1426	138	Sodium borohydride
1427	138	Sodium hydride
1428	138	Sodium
1431	138	Sodium methylate, dry
1432	139	Sodium phosphide
1433	139	Stannic phosphides
1435	138	Zinc ashes

**ID Guide Name of Material
No. No.**

1435	138	Zinc dross
1435	138	Zinc residue
1435	138	Zinc skimmings
1436	138	Zinc dust
1436	138	Zinc powder
1437	138	Zirconium hydride
1438	140	Aluminum nitrate
1439	141	Ammonium dichromate
1442	143	Ammonium perchlorate
1444	140	Ammonium persulfate
1444	140	Ammonium persulphate
1445	141	Barium chlorate, solid
1446	141	Barium nitrate
1447	141	Barium perchlorate, solid
1448	141	Barium permanganate
1449	141	Barium peroxide
1450	140	Bromates, inorganic, n.o.s.
1451	140	Caesium nitrate
1451	140	Cesium nitrate
1452	140	Calcium chlorate
1453	140	Calcium chlorite
1454	140	Calcium nitrate
1455	140	Calcium perchlorate
1456	140	Calcium permanganate
1457	140	Calcium peroxide
1458	140	Borate and Chlorate mixture
1458	140	Chlorate and Borate mixture
1459	140	Chlorate and Magnesium chloride mixture, solid
1459	140	Magnesium chloride and Chlorate mixture, solid
1461	140	Chlorates, inorganic, n.o.s.

**ID Guide Name of Material
No. No.**

1462	143	Chlorites, inorganic, n.o.s.
1463	141	Chromium trioxide, anhydrous
1465	140	Didymium nitrate
1466	140	Ferric nitrate
1467	143	Guanidine nitrate
1469	141	Lead nitrate
1470	141	Lead perchlorate, solid
1471	140	Lithium hypochlorite, dry
1471	140	Lithium hypochlorite mixture
1471	140	Lithium hypochlorite mixtures, dry
1472	143	Lithium peroxide
1473	140	Magnesium bromate
1474	140	Magnesium nitrate
1475	140	Magnesium perchlorate
1476	140	Magnesium peroxide
1477	140	Nitrates, inorganic, n.o.s.
1479	140	Oxidizing solid, n.o.s.
1481	140	Perchlorates, inorganic, n.o.s.
1482	140	Permanganates, inorganic, n.o.s.
1483	140	Peroxides, inorganic, n.o.s.
1484	140	Potassium bromate
1485	140	Potassium chlorate
1486	140	Potassium nitrate
1487	140	Potassium nitrate and Sodium nitrite mixture
1487	140	Sodium nitrite and Potassium nitrate mixture
1488	140	Potassium nitrite
1489	140	Potassium perchlorate
1490	140	Potassium permanganate
1491	144	Potassium peroxide

**ID Guide Name of Material
No. No.**

1492	140	Potassium persulfate
1492	140	Potassium persulphate
1493	140	Silver nitrate
1494	140	Sodium bromate
1495	140	Sodium chlorate
1496	143	Sodium chlorite
1498	140	Sodium nitrate
1499	140	Potassium nitrate and Sodium nitrate mixture
1499	140	Sodium nitrate and Potassium nitrate mixture
1500	141	Sodium nitrite
1502	140	Sodium perchlorate
1503	140	Sodium permanganate
1504	144	Sodium peroxide
1505	140	Sodium persulfate
1505	140	Sodium persulphate
1506	143	Strontium chlorate
1507	140	Strontium nitrate
1508	140	Strontium perchlorate
1509	143	Strontium peroxide
1510	143	Tetranitromethane
1511	140	Urea hydrogen peroxide
1512	140	Zinc ammonium nitrite
1513	140	Zinc chlorate
1514	140	Zinc nitrate
1515	140	Zinc permanganate
1516	143	Zinc peroxide
1517	113	Zirconium picramate, wetted with not less than 20% water
1541	155	Acetone cyanohydrin, stabilized
1544	151	Alkaloids, solid, n.o.s. (poisonous)

**ID Guide Name of Material
No. No.**

1544	151	Alkaloid salts, solid, n.o.s. (poisonous)
1545	155	Allyl isothiocyanate, stabilized
1546	151	Ammonium arsenate
1547	153	Aniline
1548	153	Aniline hydrochloride
1549	157	Antimony compound, inorganic, solid, n.o.s.
1550	151	Antimony lactate
1551	151	Antimony potassium tartrate
1553	154	Arsenic acid, liquid
1554	154	Arsenic acid, solid
1555	151	Arsenic bromide
1556	152	Arsenic compound, liquid, n.o.s.
1556	152	Methyldichloroarsine
1557	152	Arsenic compound, solid, n.o.s.
1558	152	Arsenic
1559	151	Arsenic pentoxide
1560	157	Arsenic chloride
1560	157	Arsenic trichloride
1561	151	Arsenic trioxide
1562	152	Arsenical dust
1564	154	Barium compound, n.o.s.
1565	157	Barium cyanide
1566	154	Beryllium compound, n.o.s.
1567	134	Beryllium powder
1569	131	Bromoacetone
1570	152	Brucine
1571	113	Barium azide, wetted with not less than 50% water
1572	151	Cacodylic acid
1573	151	Calcium arsenate

**ID Guide Name of Material
No. No.**

1574	151	Calcium arsenate and Calcium arsenite mixture, solid
1574	151	Calcium arsenite and Calcium arsenate mixture, solid
1575	157	Calcium cyanide
1577	153	Chlorodinitrobenzenes, liquid
1578	152	Chloronitrobenzenes, solid
1579	153	4-Chloro-o-toluidine hydrochloride, solid
1580	154	Chloropicrin
1581	123	Chloropicrin and Methyl bromide mixture
1581	123	Methyl bromide and Chloropicrin mixture
1582	119	Chloropicrin and Methyl chloride mixture
1582	119	Methyl chloride and Chloropicrin mixture
1583	154	Chloropicrin mixture, n.o.s.
1585	151	Copper acetoarsenite
1586	151	Copper arsenite
1587	151	Copper cyanide
1588	157	Cyanides, inorganic, solid, n.o.s.
1589	125	Cyanogen chloride, stabilized
1590	153	Dichloroanilines, liquid
1591	152	o-Dichlorobenzene
1593	160	Dichloromethane
1593	160	Methylene chloride
1594	152	Diethyl sulfate
1594	152	Diethyl sulphate
1595	156	Dimethyl sulfate
1595	156	Dimethyl sulphate
1596	153	Dinitroanilines

ID Guide Name of Material
No. No.

1597	152	Dinitrobenzenes, liquid
1598	153	Dinitro-o-cresol
1599	153	Dinitrophenol, solution
1600	152	Dinitrotoluenes, molten
1601	151	Disinfectant, solid, poisonous, n.o.s.
1601	151	Disinfectant, solid, toxic, n.o.s.
1602	151	Dye, liquid, poisonous, n.o.s.
1602	151	Dye, liquid, toxic, n.o.s.
1602	151	Dye intermediate, liquid, poisonous, n.o.s.
1602	151	Dye intermediate, liquid, toxic, n.o.s.
1603	155	Ethyl bromoacetate
1604	132	Ethylenediamine
1605	154	Ethylene dibromide
1606	151	Ferric arsenate
1607	151	Ferric arsenite
1608	151	Ferrous arsenate
1611	151	Hexaethyl tetraphosphate
1612	123	Compressed gas and hexaethyl tetraphosphate mixture
1612	123	Hexaethyl tetraphosphate and compressed gas mixture
1613	154	Hydrocyanic acid, aqueous solution, with less than 5% Hydrogen cyanide
1613	154	Hydrocyanic acid, aqueous solution, with not more than 20% Hydrogen cyanide
1613	154	Hydrogen cyanide, aqueous solution, with not more than 20% Hydrogen cyanide
1614	152	Hydrogen cyanide, stabilized (absorbed)
1616	151	Lead acetate

ID Guide Name of Material
No. No.

1617	151	Lead arsenates
1618	151	Lead arsenites
1620	151	Lead cyanide
1621	151	London purple
1622	151	Magnesium arsenate
1623	151	Mercuric arsenate
1624	154	Mercuric chloride
1625	141	Mercuric nitrate
1626	157	Mercuric potassium cyanide
1627	141	Mercurous nitrate
1629	151	Mercury acetate
1630	151	Mercury ammonium chloride
1631	154	Mercury benzoate
1634	154	Mercury bromides
1636	154	Mercury cyanide
1637	151	Mercury gluconate
1638	151	Mercury iodide
1639	151	Mercury nucleate
1640	151	Mercury oleate
1641	151	Mercury oxide
1642	151	Mercury oxycyanide, desensitized
1643	151	Mercury potassium iodide
1644	151	Mercury salicylate
1645	151	Mercury sulfate
1645	151	Mercury sulphate
1646	151	Mercury thiocyanate
1647	151	Ethylene dibromide and Methyl bromide mixture, liquid
1647	151	Methyl bromide and Ethylene dibromide mixture, liquid
1648	127	Acetonitrile

ID Guide Name of Material
No. No.

ID Guide Name of Material
No. No.

1649 **152** Motor fuel anti-knock mixture
1650 **153** beta-Naphthylamine, solid
1650 **153** Naphthylamine (beta), solid
1651 **153** Naphthylthiourea
1652 **153** Naphthylurea
1653 **151** Nickel cyanide
1654 **151** Nicotine
1655 **151** Nicotine compound, solid, n.o.s.
1655 **151** Nicotine preparation, solid,
n.o.s.
1656 **151** Nicotine hydrochloride, liquid
1656 **151** Nicotine hydrochloride, solution
1657 **151** Nicotine salicylate
1658 **151** Nicotine sulfate, solution
1658 **151** Nicotine sulphate, solution
1659 **151** Nicotine tartrate
1660 124 Nitric oxide
1660 124 Nitric oxide, compressed
1661 **153** Nitroanilines
1662 **152** Nitrobenzene
1663 **153** Nitrophenols
1664 **152** Nitrotoluenes, liquid
1665 **152** Nitroxyls, liquid
1669 **151** Pentachloroethane
1670 157 Perchloromethyl mercaptan
1671 **153** Phenol, solid
1672 151 Phenylcarbylamine chloride
1673 **153** Phenylenediamines
1674 **151** Phenylmercuric acetate
1677 **151** Potassium arsenate
1678 **154** Potassium arsenite
1679 **157** Potassium cuprocyanide

1680 157 Potassium cyanide, solid
1683 **151** Silver arsenite
1684 **151** Silver cyanide
1685 **151** Sodium arsenate
1686 **154** Sodium arsenite, aqueous
solution
1687 **153** Sodium azide
1688 **152** Sodium cacodylate
1689 157 Sodium cyanide, solid
1690 **154** Sodium fluoride, solid
1691 **151** Strontium arsenite
1692 **151** Strychnine
1692 **151** Strychnine salts
1693 **159** Tear gas devices
1693 **159** Tear gas substance, liquid,
n.o.s.
1694 **159** Bromobenzyl cyanides, liquid
1695 131 Chloroacetone, stabilized
1697 **153** Chloroacetophenone, solid
1698 **154** Diphenylamine chloroarsine
1699 **151** Diphenylchloroarsine, liquid
1700 **159** Tear gas candles
1700 **159** Tear gas grenades
1701 **152** Xylyl bromide, liquid
1702 **151** 1,1,2,2-Tetrachloroethane
1704 **153** Tetraethyl dithiopyrophosphate
1707 **151** Thallium compound, n.o.s.
1708 **153** Tolidines, liquid
1709 **151** 2,4-Toluenediamine, solid
1709 **151** 2,4-Toluylenediamine, solid
1710 **160** Trichloroethylene
1711 **153** Xylidines, liquid

**ID Guide Name of Material
No. No.**

1712	151	Zinc arsenate
1712	151	Zinc arsenate and Zinc arsenite mixture
1712	151	Zinc arsenite
1712	151	Zinc arsenite and Zinc arsenate mixture
1713	151	Zinc cyanide
1714	139	Zinc phosphide
1715	137	Acetic anhydride
1716	156	Acetyl bromide
1717	155	Acetyl chloride
1718	153	Acid butyl phosphate
1718	153	Butyl acid phosphate
1719	154	Caustic alkali liquid, n.o.s.
1722	155	Allyl chlorocarbonate
1722	155	Allyl chloroformate
1723	132	Allyl iodide
1724	155	Allyltrichlorosilane, stabilized
1725	137	Aluminum bromide, anhydrous
1726	137	Aluminum chloride, anhydrous
1727	154	Ammonium bifluoride, solid
1727	154	Ammonium hydrogendifluoride, solid
1728	155	Amyltrichlorosilane
1729	156	Anisoyl chloride
1730	157	Antimony pentachloride, liquid
1731	157	Antimony pentachloride, solution
1732	157	Antimony pentafluoride
1733	157	Antimony trichloride
1733	157	Antimony trichloride, liquid
1733	157	Antimony trichloride, solid
1736	137	Benzoyl chloride

**ID Guide Name of Material
No. No.**

1737	156	Benzyl bromide
1738	156	Benzyl chloride
1739	137	Benzyl chloroformate
1740	154	Hydrogendifluorides, solid, n.o.s.
1741	125	Boron trichloride
1742	157	Boron trifluoride acetic acid complex, liquid
1743	157	Boron trifluoride propionic acid complex, liquid
1744	154	Bromine
1744	154	Bromine, solution
1744	154	Bromine, solution (Inhalation Hazard Zone A)
1744	154	Bromine, solution (Inhalation Hazard Zone B)
1745	144	Bromine pentafluoride
1746	144	Bromine trifluoride
1747	155	Butyltrichlorosilane
1748	140	Calcium hypochlorite, dry
1748	140	Calcium hypochlorite mixture, dry, with more than 39% available Chlorine (8.8% available Oxygen)
1749	124	Chlorine trifluoride
1750	153	Chloroacetic acid, solution
1751	153	Chloroacetic acid, solid
1752	156	Chloroacetyl chloride
1753	156	Chlorophenyltrichlorosilane
1754	137	Chlorosulfonic acid (with or without sulfur trioxide)
1754	137	Chlorosulphonic acid (with or without sulphur trioxide)
1755	154	Chromic acid, solution
1756	154	Chromic fluoride, solid

**ID Guide Name of Material
No. No.**

1757	154	Chromic fluoride, solution
1758	137	Chromium oxychloride
1759	154	Corrosive solid, n.o.s.
1759	154	Ferrous chloride, solid
1760	154	Chemical kit
1760	154	Compounds, cleaning liquid (corrosive)
1760	154	Compounds, tree or weed killing, liquid (corrosive)
1760	154	Corrosive liquid, n.o.s.
1760	154	Ferrous chloride, solution
1761	154	Cupriethylenediamine, solution
1762	156	Cyclohexenyltrichlorosilane
1763	156	Cyclohexyltrichlorosilane
1764	153	Dichloroacetic acid
1765	156	Dichloroacetyl chloride
1766	156	Dichlorophenyltrichlorosilane
1767	155	Diethyldichlorosilane
1768	154	Difluorophosphoric acid, anhydrous
1769	156	Diphenyldichlorosilane
1770	153	Diphenylmethyl bromide
1771	156	Dodecyltrichlorosilane
1773	157	Ferric chloride, anhydrous
1774	154	Fire extinguisher charges, corrosive liquid
1775	154	Fluoroboric acid
1776	154	Fluorophosphoric acid, anhydrous
1777	137	Fluorosulfonic acid
1777	137	Fluorosulphonic acid
1778	154	Fluorosilicic acid
1778	154	Hydrofluorosilicic acid

**ID Guide Name of Material
No. No.**

1779	153	Formic acid
1779	153	Formic acid, with more than 85% acid
1780	156	Fumaryl chloride
1781	156	Hexadecyltrichlorosilane
1782	154	Hexafluorophosphoric acid
1783	153	Hexamethylenediamine, solution
1784	156	Hexyltrichlorosilane
1786	157	Hydrofluoric acid and Sulfuric acid mixture
1786	157	Hydrofluoric acid and Sulphuric acid mixture
1786	157	Sulfuric acid and Hydrofluoric acid mixture
1786	157	Sulphuric acid and Hydrofluoric acid mixture
1787	154	Hydriodic acid
1788	154	Hydrobromic acid
1789	157	Hydrochloric acid
1789	157	Muriatic acid
1790	157	Hydrofluoric acid
1791	154	Hypochlorite solution
1791	154	Sodium hypochlorite
1792	157	Iodine monochloride, solid
1793	153	Isopropyl acid phosphate
1794	154	Lead sulfate, with more than 3% free acid
1794	154	Lead sulphate, with more than 3% free acid
1796	157	Nitrating acid mixture with more than 50% nitric acid
1796	157	Nitrating acid mixture with not more than 50% nitric acid
1798	157	Aqua regia
1798	157	Nitrohydrochloric acid

**ID Guide Name of Material
No. No.**

1799	156	Nonyltrichlorosilane
1800	156	Octadecyltrichlorosilane
1801	156	Octyltrichlorosilane
1802	157	Perchloric acid, with not more than 50% acid
1803	153	Phenolsulfonic acid, liquid
1803	153	Phenolsulphonic acid, liquid
1804	156	Phenyltrichlorosilane
1805	154	Phosphoric acid, solution
1806	137	Phosphorus pentachloride
1807	137	Phosphorus pentoxide
1808	137	Phosphorus tribromide
1809	137	Phosphorus trichloride
1810	137	Phosphorus oxychloride
1811	154	Potassium hydrogen difluoride, solid
1812	154	Potassium fluoride, solid
1813	154	Caustic potash, solid
1813	154	Potassium hydroxide, solid
1814	154	Caustic potash, solution
1814	154	Potassium hydroxide, solution
1815	132	Propionyl chloride
1816	155	Propyltrichlorosilane
1817	137	Pyrosulfuryl chloride
1817	137	Pyrosulphuryl chloride
1818	157	Silicon tetrachloride
1819	154	Sodium aluminate, solution
1823	154	Caustic soda, solid
1823	154	Sodium hydroxide, solid
1824	154	Caustic soda, solution
1824	154	Sodium hydroxide, solution
1825	157	Sodium monoxide

**ID Guide Name of Material
No. No.**

1826	157	Nitrating acid mixture, spent, with more than 50% nitric acid
1826	157	Nitrating acid mixture, spent, with not more than 50% nitric acid
1827	137	Stannic chloride, anhydrous
1827	137	Tin tetrachloride
1828	137	Sulfur chlorides
1828	137	Sulphur chlorides
1829	137	Sulfur trioxide, stabilized
1829	137	Sulphur trioxide, stabilized
1830	137	Sulfuric acid
1830	137	Sulfuric acid, with more than 51% acid
1830	137	Sulphuric acid
1830	137	Sulphuric acid, with more than 51% acid
1831	137	Sulfuric acid, fuming
1831	137	Sulphuric acid, fuming
1832	137	Sulfuric acid, spent
1832	137	Sulphuric acid, spent
1833	154	Sulfurous acid
1833	154	Sulphurous acid
1834	137	Sulfuryl chloride
1834	137	Sulphuryl chloride
1835	153	Tetramethylammonium hydroxide, solution
1836	137	Thionyl chloride
1837	157	Thiophosphoryl chloride
1838	137	Titanium tetrachloride
1839	153	Trichloroacetic acid
1840	154	Zinc chloride, solution
1841	171	Acetaldehyde ammonia

**ID Guide Name of Material
No. No.**

1843	141	Ammonium dinitro-o-cresolate, solid
1845	120	Carbon dioxide, solid
1845	120	Dry ice
1846	151	Carbon tetrachloride
1847	153	Potassium sulfide, hydrated, with not less than 30% water of crystallization
1847	153	Potassium sulphide, hydrated, with not less than 30% water of crystallization
1848	153	Propionic acid
1848	153	Propionic acid, with not less than 10% and less than 90% acid
1849	153	Sodium sulfide, hydrated, with not less than 30% water
1849	153	Sodium sulphide, hydrated, with not less than 30% water
1851	151	Medicine, liquid, poisonous, n.o.s.
1851	151	Medicine, liquid, toxic, n.o.s.
1854	135	Barium alloys, pyrophoric
1855	135	Calcium, pyrophoric
1855	135	Calcium alloys, pyrophoric
1856	133	Rags, oily
1857	133	Textile waste, wet
1858	126	Hexafluoropropylene
1858	126	Hexafluoropropylene, compressed
1858	126	Refrigerant gas R-1216
1859	125	Silicon tetrafluoride
1859	125	Silicon tetrafluoride, compressed
1860	116P	Vinyl fluoride, stabilized
1862	130	Ethyl crotonate

**ID Guide Name of Material
No. No.**

1863	128	Fuel, aviation, turbine engine
1865	128	n-Propyl nitrate
1866	127	Resin solution
1868	134	Decaborane
1869	138	Magnesium
1869	138	Magnesium, in pellets, turnings or ribbons
1869	138	Magnesium alloys, with more than 50% Magnesium, in pellets, turnings or ribbons
1870	138	Potassium borohydride
1871	170	Titanium hydride
1872	140	Lead dioxide
1873	143	Perchloric acid, with more than 50% but not more than 72% acid
1884	157	Barium oxide
1885	153	Benzidine
1886	156	Benzylidene chloride
1887	160	Bromochloromethane
1888	151	Chloroform
1889	157	Cyanogen bromide
1891	131	Ethyl bromide
1892	151	Ethylidichloroarsine
1894	151	Phenylmercuric hydroxide
1895	151	Phenylmercuric nitrate
1897	160	Perchloroethylene
1897	160	Tetrachloroethylene
1898	156	Acetyl iodide
1902	153	Diisooctyl acid phosphate
1903	153	Disinfectant, liquid, corrosive, n.o.s.
1905	154	Selenic acid
1906	153	Acid, sludge

**ID Guide Name of Material
No. No.**

1906	153	Sludge acid
1907	154	Soda lime, with more than 4% Sodium hydroxide
1908	154	Chlorite solution
1910	157	Calcium oxide
1911	119	Diborane
1911	119	Diborane, compressed
1911	119	Diborane mixtures
1912	115	Methyl chloride and Methylene chloride mixture
1912	115	Methylene chloride and Methyl chloride mixture
1913	120	Neon, refrigerated liquid (cryogenic liquid)
1914	130	Butyl propionates
1915	127	Cyclohexanone
1916	152	2,2'-Dichlorodiethyl ether
1916	152	Dichloroethyl ether
1917	129P	Ethyl acrylate, stabilized
1918	130	Cumene
1918	130	Isopropylbenzene
1919	129P	Methyl acrylate, stabilized
1920	128	Nonanes
1921	131P	Propyleneimine, stabilized
1922	132	Pyrrolidine
1923	135	Calcium dithionite
1923	135	Calcium hydrosulfite
1923	135	Calcium hydrosulphite
1928	138	Methyl magnesium bromide in Ethyl ether
1929	135	Potassium dithionite
1929	135	Potassium hydrosulfite
1929	135	Potassium hydrosulphite

**ID Guide Name of Material
No. No.**

1931	171	Zinc dithionite
1931	171	Zinc hydrosulfite
1931	171	Zinc hydrosulphite
1932	135	Zirconium scrap
1935	157	Cyanide solution, n.o.s.
1938	156	Bromoacetic acid, solution
1939	137	Phosphorus oxybromide, solid
1940	153	Thioglycolic acid
1941	171	Dibromodifluoromethane
1941	171	Refrigerant gas R-12B2
1942	140	Ammonium nitrate, with not more than 0.2% combustible substances
1944	133	Matches, safety
1945	133	Matches, wax "vesta"
1950	126	Aerosols
1951	120	Argon, refrigerated liquid (cryogenic liquid)
1952	126	Carbon dioxide and Ethylene oxide mixtures, with not more than 9% Ethylene oxide
1952	126	Ethylene oxide and Carbon dioxide mixtures, with not more than 9% Ethylene oxide
1953	119	Compressed gas, poisonous, flammable, n.o.s.
1953	119	Compressed gas, poisonous, flammable, n.o.s. (Inhalation Hazard Zone A)
1953	119	Compressed gas, poisonous, flammable, n.o.s. (Inhalation Hazard Zone B)
1953	119	Compressed gas, poisonous, flammable, n.o.s. (Inhalation Hazard Zone C)
1953	119	Compressed gas, poisonous, flammable, n.o.s. (Inhalation Hazard Zone D)

ID Guide No. No. Name of Material

ID Guide No. No. Name of Material

1953 119 Compressed gas, toxic, flammable, n.o.s.

1953 119 Compressed gas, toxic, flammable, n.o.s. (Inhalation Hazard Zone A)

1953 119 Compressed gas, toxic, flammable, n.o.s. (Inhalation Hazard Zone B)

1953 119 Compressed gas, toxic, flammable, n.o.s. (Inhalation Hazard Zone C)

1953 119 Compressed gas, toxic, flammable, n.o.s. (Inhalation Hazard Zone D)

1954 115 Compressed gas, flammable, n.o.s.

1954 115 Dispersant gases, n.o.s. (flammable)

1954 115 Refrigerant gases, n.o.s. (flammable)

1955 123 Compressed gas, poisonous, n.o.s.

1955 123 Compressed gas, poisonous, n.o.s. (Inhalation Hazard Zone A)

1955 123 Compressed gas, poisonous, n.o.s. (Inhalation Hazard Zone B)

1955 123 Compressed gas, poisonous, n.o.s. (Inhalation Hazard Zone C)

1955 123 Compressed gas, poisonous, n.o.s. (Inhalation Hazard Zone D)

1955 123 Compressed gas, toxic, n.o.s.

1955 123 Compressed gas, toxic, n.o.s. (Inhalation Hazard Zone A)

1955 123 Compressed gas, toxic, n.o.s. (Inhalation Hazard Zone B)

1955 123 Compressed gas, toxic, n.o.s. (Inhalation Hazard Zone C)

1955 123 Compressed gas, toxic, n.o.s. (Inhalation Hazard Zone D)

1955 123 Organic phosphate compound mixed with compressed gas

1955 123 Organic phosphate mixed with compressed gas

1955 123 Organic phosphorus compound mixed with compressed gas

1956 126 Compressed gas, n.o.s.

1957 115 Deuterium

1957 115 Deuterium, compressed

1958 126 1,2-Dichloro-1,1,2,2-tetrafluoroethane

1958 126 Refrigerant gas R-114

1959 116P 1,1-Difluoroethylene

1959 116P Refrigerant gas R-1132a

1961 115 Ethane, refrigerated liquid

1961 115 Ethane-Propane mixture, refrigerated liquid

1961 115 Propane-Ethane mixture, refrigerated liquid

1962 116P Ethylene

1962 116P Ethylene, compressed

1963 120 Helium, refrigerated liquid (cryogenic liquid)

1964 115 Hydrocarbon gas mixture, compressed, n.o.s.

1965 115 Hydrocarbon gas mixture, liquefied, n.o.s.

1966 115 Hydrogen, refrigerated liquid (cryogenic liquid)

1967 123 Insecticide gas, poisonous, n.o.s.

1967 123 Insecticide gas, toxic, n.o.s.

1967 123 Parathion and compressed gas mixture

ID Guide Name of Material
No. No.

1968	126	Insecticide gas, n.o.s.
1969	115	Isobutane
1970	120	Krypton, refrigerated liquid (cryogenic liquid)
1971	115	Methane
1971	115	Methane, compressed
1971	115	Natural gas, compressed
1972	115	Liquefied natural gas (cryogenic liquid)
1972	115	LNG (cryogenic liquid)
1972	115	Methane, refrigerated liquid (cryogenic liquid)
1972	115	Natural gas, refrigerated liquid (cryogenic liquid)
1973	126	Chlorodifluoromethane and Chloropentafluoroethane mixture
1973	126	Chloropentafluoroethane and Chlorodifluoromethane mixture
1973	126	Refrigerant gas R-502
1974	126	Chlorodifluorobromomethane
1974	126	Refrigerant gas R-12B1
1975	124	Dinitrogen tetroxide and Nitric oxide mixture
1975	124	Nitric oxide and Dinitrogen tetroxide mixture
1975	124	Nitric oxide and Nitrogen dioxide mixture
1975	124	Nitrogen dioxide and Nitric oxide mixture
1976	126	Octafluorocyclobutane
1976	126	Refrigerant gas RC-318
1977	120	Nitrogen, refrigerated liquid (cryogenic liquid)
1978	115	Propane

ID Guide Name of Material
No. No.

1982	126	Refrigerant gas R-14
1982	126	Refrigerant gas R-14, compressed
1982	126	Tetrafluoromethane
1982	126	Tetrafluoromethane, compressed
1983	126	1-Chloro-2,2,2-trifluoroethane
1983	126	Refrigerant gas R-133a
1984	126	Refrigerant gas R-23
1984	126	Trifluoromethane
1986	131	Alcohols, flammable, poisonous, n.o.s.
1986	131	Alcohols, flammable, toxic, n.o.s.
1987	127	Alcohols, n.o.s.
1987	127	Denatured alcohol
1988	131P	Aldehydes, flammable, poisonous, n.o.s.
1988	131P	Aldehydes, flammable, toxic, n.o.s.
1989	129P	Aldehydes, n.o.s.
1990	171	Benzaldehyde
1991	131P	Chloroprene, stabilized
1992	131	Flammable liquid, poisonous, n.o.s.
1992	131	Flammable liquid, toxic, n.o.s.
1993	128	Combustible liquid, n.o.s.
1993	128	Compounds, cleaning liquid (flammable)
1993	128	Compounds, tree or weed killing, liquid (flammable)
1993	128	Diesel fuel
1993	128	Flammable liquid, n.o.s.
1993	128	Fuel oil
1994	136	Iron pentacarbonyl

**ID Guide Name of Material
No. No.**

1999	130	Asphalt
1999	130	Asphalt, cut back
1999	130	Tars, liquid
2000	133	Celluloid, in blocks, rods, rolls, sheets, tubes, etc., except scrap
2001	133	Cobalt naphthenates, powder
2002	135	Celluloid, scrap
2004	135	Magnesium diamide
2005	135	Magnesium diphenyl
2006	135	Plastics, nitrocellulose-based, self-heating, n.o.s.
2008	135	Zirconium powder, dry
2009	135	Zirconium, dry, finished sheets, strips or coiled wire
2010	138	Magnesium hydride
2011	139	Magnesium phosphide
2012	139	Potassium phosphide
2013	139	Strontium phosphide
2014	140	Hydrogen peroxide, aqueous solution, with not less than 20% but not more than 60% Hydrogen peroxide (stabilized as necessary)
2015	143	Hydrogen peroxide, aqueous solution, stabilized, with more than 60% Hydrogen peroxide
2015	143	Hydrogen peroxide, stabilized
2016	151	Ammunition, poisonous, non-explosive
2016	151	Ammunition, toxic, non-explosive
2017	159	Ammunition, tear-producing, non-explosive
2018	152	Chloroanilines, solid
2019	152	Chloroanilines, liquid

**ID Guide Name of Material
No. No.**

2020	153	Chlorophenols, solid
2021	153	Chlorophenols, liquid
2022	153	Cresylic acid
2023	131P	Epichlorohydrin
2024	151	Mercury compound, liquid, n.o.s.
2025	151	Mercury compound, solid, n.o.s.
2026	151	Phenylmercuric compound, n.o.s.
2027	151	Sodium arsenite, solid
2028	153	Bombs, smoke, non-explosive, with corrosive liquid, without initiating device
2029	132	Hydrazine, anhydrous
2030	153	Hydrazine, aqueous solution, with more than 37% Hydrazine
2031	157	Nitric acid, other than red fuming, with more than 65% nitric acid
2031	157	Nitric acid, other than red fuming, with not more than 65% nitric acid
2032	157	Nitric acid, red fuming
2033	154	Potassium monoxide
2034	115	Hydrogen and Methane mixture, compressed
2034	115	Methane and Hydrogen mixture, compressed
2035	115	Refrigerant gas R-143a
2035	115	1,1,1-Trifluoroethane
2036	120	Xenon
2036	120	Xenon, compressed
2037	115	Gas cartridges
2037	115	Receptacles, small, containing gas

ID Guide Name of Material
No. No.

2038	152	Dinitrotoluenes, liquid
2044	115	2,2-Dimethylpropane
2045	130	Isobutyl aldehyde
2045	130	Isobutyraldehyde
2046	130	Cymenes
2047	129	Dichloropropenes
2048	130P	Dicyclopentadiene
2049	130	Diethylbenzene
2050	128	Diisobutylene, isomeric compounds
2051	132	2-Dimethylaminoethanol
2052	128	Dipentene
2053	129	Methylamyl alcohol
2053	129	Methyl isobutyl carbinol
2054	132	Morpholine
2055	128P	Styrene monomer, stabilized
2056	127	Tetrahydrofuran
2057	128	Tripropylene
2058	129	Valeraldehyde
2059	127	Nitrocellulose, solution, flammable
2067	140	Ammonium nitrate based fertilizer
2071	140	Ammonium nitrate based fertilizer
2073	125	Ammonia, solution, with more than 35% but not more than 50% Ammonia
2074	153P	Acrylamide, solid
2075	153	Chloral, anhydrous, stabilized
2076	153	Cresols, liquid
2077	153	alpha-Naphthylamine
2077	153	Naphthylamine (alpha)
2078	156	Toluene diisocyanate

ID Guide Name of Material
No. No.

2079	154	Diethylenetriamine
2186	125	Hydrogen chloride, refrigerated liquid
2187	120	Carbon dioxide, refrigerated liquid
2188	119	Arsine
2189	119	Dichlorosilane
2190	124	Oxygen difluoride
2190	124	Oxygen difluoride, compressed
2191	123	Sulfuryl fluoride
2191	123	Sulphuryl fluoride
2192	119	Germane
2193	126	Hexafluoroethane
2193	126	Hexafluoroethane, compressed
2193	126	Refrigerant gas R-116
2193	126	Refrigerant gas R-116, compressed
2194	125	Selenium hexafluoride
2195	125	Tellurium hexafluoride
2196	125	Tungsten hexafluoride
2197	125	Hydrogen iodide, anhydrous
2198	125	Phosphorus pentafluoride
2198	125	Phosphorus pentafluoride, compressed
2199	119	Phosphine
2200	116P	Propadiene, stabilized
2201	122	Nitrous oxide, refrigerated liquid
2202	117	Hydrogen selenide, anhydrous
2203	116	Silane
2203	116	Silane, compressed
2204	119	Carbonyl sulfide
2204	119	Carbonyl sulphide
2205	153	Adiponitrile

**ID Guide Name of Material
No. No.**

2206	155	Isocyanate solution, poisonous, n.o.s.
2206	155	Isocyanate solution, toxic, n.o.s.
2206	155	Isocyanates, poisonous, n.o.s.
2206	155	Isocyanates, toxic, n.o.s.
2208	140	Bleaching powder
2208	140	Calcium hypochlorite mixture, dry, with more than 10% but not more than 39% available Chlorine
2209	153	Formaldehyde, solution (corrosive)
2209	153	Formalin (corrosive)
2210	135	Maneb
2210	135	Maneb preparation, with not less than 60% Maneb
2211	171	Polymeric beads, expandable
2212	171	Asbestos
2212	171	Asbestos, amphibole
2212	171	Asbestos, blue
2212	171	Asbestos, brown
2212	171	Blue asbestos
2212	171	Brown asbestos
2213	133	Paraformaldehyde
2214	156	Phthalic anhydride
2215	156	Maleic anhydride
2215	156	Maleic anhydride, molten
2216	171	Fish meal, stabilized
2216	171	Fish scrap, stabilized
2217	135	Seed cake, with not more than 1.5% oil and not more than 11% moisture
2218	132P	Acrylic acid, stabilized
2219	129	Allyl glycidyl ether

**ID Guide Name of Material
No. No.**

2222	128	Anisole
2224	152	Benzonitrile
2225	156	Benzenesulfonyl chloride
2225	156	Benzenesulphonyl chloride
2226	156	Benzotrichloride
2227	130P	n-Butyl methacrylate, stabilized
2232	153	Chloroacetaldehyde
2232	153	2-Chloroethanal
2233	152	Chloroanisidines
2234	130	Chlorobenzotrifluorides
2235	153	Chlorobenzyl chlorides, liquid
2236	156	3-Chloro-4-methylphenyl isocyanate, liquid
2237	153	Chloronitroanilines
2238	129	Chlorotoluenes
2239	153	Chlorotoluidines, solid
2240	154	Chromosulfuric acid
2240	154	Chromosulphuric acid
2241	128	Cycloheptane
2242	128	Cycloheptene
2243	130	Cyclohexyl acetate
2244	129	Cyclopentanol
2245	128	Cyclopentanone
2246	128	Cyclopentene
2247	128	n-Decane
2248	132	Di-n-butylamine
2249	131	Dichlorodimethyl ether, symmetrical
2250	156	Dichlorophenyl isocyanates
2251	128P	Bicyclo[2.2.1]hepta-2,5-diene, stabilized
2251	128P	2,5-Norbornadiene, stabilized

**ID Guide Name of Material
No. No.**

2252	127	1,2-Dimethoxyethane
2253	153	N,N-Dimethylaniline
2254	133	Matches, fusee
2256	130	Cyclohexene
2257	138	Potassium
2258	132	1,2-Propylenediamine
2259	153	Triethylenetetramine
2260	132	Tripropylamine
2261	153	Xylenols, solid
2262	156	Dimethylcarbamoyl chloride
2263	128	Dimethylcyclohexanes
2264	132	N,N-Dimethylcyclohexylamine
2264	132	Dimethylcyclohexylamine
2265	129	N,N-Dimethylformamide
2266	132	Dimethyl-N-propylamine
2267	156	Dimethyl thiophosphoryl chloride
2269	153	3,3'-Iminodipropylamine
2270	132	Ethylamine, aqueous solution, with not less than 50% but not more than 70% Ethylamine
2271	128	Ethyl amyl ketone
2272	153	N-Ethylaniline
2273	153	2-Ethylaniline
2274	153	N-Ethyl-N-benzylaniline
2275	129	2-Ethylbutanol
2276	132	2-Ethylhexylamine
2277	130P	Ethyl methacrylate, stabilized
2278	128	n-Heptene
2279	151	Hexachlorobutadiene
2280	153	Hexamethylenediamine, solid
2281	156	Hexamethylene diisocyanate

**ID Guide Name of Material
No. No.**

2282	129	Hexanols
2283	130P	Isobutyl methacrylate, stabilized
2284	131	Isobutyronitrile
2285	156	Isocyanatobenzotrifluorides
2286	128	Pentamethylheptane
2287	128	Isoheptenes
2288	128	Isohexenes
2289	153	Isophoronediamine
2290	156	Isophorone diisocyanate
2291	151	Lead compound, soluble, n.o.s.
2293	128	4-Methoxy-4-methylpentan-2- one
2294	153	N-Methylaniline
2295	155	Methyl chloroacetate
2296	128	Methylcyclohexane
2297	128	Methylcyclohexanone
2298	128	Methylcyclopentane
2299	155	Methyl dichloroacetate
2300	153	2-Methyl-5-ethylpyridine
2301	128	2-Methylfuran
2302	127	5-Methylhexan-2-one
2303	128	Isopropenylbenzene
2304	133	Naphthalene, molten
2305	153	Nitrobenzenesulfonic acid
2305	153	Nitrobenzenesulphonic acid
2306	152	Nitrobenzotrifluorides, liquid
2307	152	3-Nitro-4-chlorobenzotrifluoride
2308	157	Nitrosylsulfuric acid, liquid
2308	157	Nitrosylsulphuric acid, liquid
2309	128P	Octadiene
2310	131	Pentane-2,4-dione
2311	153	Phenetidines

ID Guide No. No. Name of Material

2312	153	Phenol, molten
2313	129	Picolines
2315	171	Articles containing Polychlorinated biphenyls (PCB)
2315	171	PCB
2315	171	Polychlorinated biphenyls, liquid
2316	157	Sodium cuprocyanide, solid
2317	157	Sodium cuprocyanide, solution
2318	135	Sodium hydrosulfide, with less than 25% water of crystallization
2318	135	Sodium hydrosulphide, with less than 25% water of crystallization
2319	128	Terpene hydrocarbons, n.o.s.
2320	153	Tetraethylenepentamine
2321	153	Trichlorobenzenes, liquid
2322	152	Trichlorobutene
2323	130	Triethyl phosphite
2324	128	Triisobutylene
2325	129	1,3,5-Trimethylbenzene
2326	153	Trimethylcyclohexylamine
2327	153	Trimethylhexamethylenediamines
2328	156	Trimethylhexamethylene diisocyanate
2329	130	Trimethyl phosphite
2330	128	Undecane
2331	154	Zinc chloride, anhydrous
2332	129	Acetaldehyde oxime
2333	131	Allyl acetate
2334	131	Allylamine
2335	131	Allyl ethyl ether
2336	131	Allyl formate

ID Guide No. No. Name of Material

2337	131	Phenyl mercaptan
2338	127	Benzotrifluoride
2339	130	2-Bromobutane
2340	130	2-Bromoethyl ethyl ether
2341	130	1-Bromo-3-methylbutane
2342	130	Bromomethylpropanes
2343	130	2-Bromopentane
2344	129	Bromopropanes
2345	130	3-Bromopropyne
2346	127	Butanedione
2346	127	Diacetyl
2347	130	Butyl mercaptan
2348	129P	Butyl acrylates, stabilized
2350	127	Butyl methyl ether
2351	129	Butyl nitrites
2352	127P	Butyl vinyl ether, stabilized
2353	132	Butyryl chloride
2354	131	Chloromethyl ethyl ether
2356	129	2-Chloropropane
2357	132	Cyclohexylamine
2358	128P	Cyclooctatetraene
2359	132	Diallylamine
2360	131P	Diallyl ether
2361	132	Diisobutylamine
2362	130	1,1-Dichloroethane
2363	129	Ethyl mercaptan
2364	128	n-Propyl benzene
2366	128	Diethyl carbonate
2367	130	alpha-Methylvaleraldehyde
2367	130	Methyl valeraldehyde (alpha)
2368	128	alpha-Pinene

**ID Guide Name of Material
No. No.**

2368	128	Pinene (alpha)
2370	128	1-Hexene
2371	128	Isopentenes
2372	129	1,2-Di-(dimethylamino)ethane
2373	127	Diethoxymethane
2374	127	3,3-Diethoxypropene
2375	129	Diethyl sulfide
2375	129	Diethyl sulphide
2376	127	2,3-Dihydropyran
2377	127	1,1-Dimethoxyethane
2378	131	2-Dimethylaminoacetonitrile
2379	132	1,3-Dimethylbutylamine
2380	127	Dimethyldiethoxysilane
2381	131	Dimethyl disulfide
2381	131	Dimethyl disulphide
2382	131	Dimethylhydrazine, symmetrical
2383	132	Dipropylamine
2384	127	Di-n-propyl ether
2385	129	Ethyl isobutyrate
2386	132	1-Ethylpiperidine
2387	130	Fluorobenzene
2388	130	Fluorotoluenes
2389	128	Furan
2390	129	2-Iodobutane
2391	129	Iodomethylpropanes
2392	129	Iodopropanes
2393	129	Isobutyl formate
2394	129	Isobutyl propionate
2395	132	Isobutyryl chloride
2396	131P	Methacrylaldehyde, stabilized
2397	127	3-Methylbutan-2-one

**ID Guide Name of Material
No. No.**

2398	127	Methyl tert-butyl ether
2399	132	1-Methylpiperidine
2400	130	Methyl isovalerate
2401	132	Piperidine
2402	130	Propanethiols
2403	129P	Isopropenyl acetate
2404	131	Propionitrile
2405	129	Isopropyl butyrate
2406	127	Isopropyl isobutyrate
2407	155	Isopropyl chloroformate
2409	129	Isopropyl propionate
2410	129	1,2,3,6-Tetrahydropyridine
2411	131	Butyronitrile
2412	130	Tetrahydrothiophene
2413	128	Tetrapropyl orthotitanate
2414	130	Thiophene
2416	129	Trimethyl borate
2417	125	Carbonyl fluoride
2417	125	Carbonyl fluoride, compressed
2418	125	Sulfur tetrafluoride
2418	125	Sulphur tetrafluoride
2419	116	Bromotrifluoroethylene
2420	125	Hexafluoroacetone
2421	124	Nitrogen trioxide
2422	126	Octafluorobut-2-ene
2422	126	Refrigerant gas R-1318
2424	126	Octafluoropropane
2424	126	Refrigerant gas R-218
2426	140	Ammonium nitrate, liquid (hot concentrated solution)
2427	140	Potassium chlorate, aqueous solution

**ID Guide Name of Material
No. No.**

2428	140	Sodium chlorate, aqueous solution
2429	140	Calcium chlorate, aqueous solution
2430	153	Alkylphenols, solid, n.o.s. (including C2-C12 homologues)
2431	153	Anisidines
2432	153	N,N-Diethylaniline
2433	152	Chloronitrotoluenes, liquid
2434	156	Dibenzylidichlorosilane
2435	156	Ethylphenyldichlorosilane
2436	129	Thioacetic acid
2437	156	Methylphenyldichlorosilane
2438	131	Trimethylacetyl chloride
2439	154	Sodium hydrogendifluoride
2440	154	Stannic chloride, pentahydrate
2441	135	Titanium trichloride, pyrophoric
2441	135	Titanium trichloride mixture, pyrophoric
2442	156	Trichloroacetyl chloride
2443	137	Vanadium oxytrichloride
2444	137	Vanadium tetrachloride
2446	153	Nitrocresols, solid
2447	136	Phosphorus, white, molten
2447	136	White phosphorus, molten
2448	133	Molten sulfur
2448	133	Molten sulphur
2448	133	Sulfur, molten
2448	133	Sulphur, molten
2451	122	Nitrogen trifluoride
2451	122	Nitrogen trifluoride, compressed
2452	116P	Ethylacetylene, stabilized

**ID Guide Name of Material
No. No.**

2453	115	Ethyl fluoride
2453	115	Refrigerant gas R-161
2454	115	Methyl fluoride
2454	115	Refrigerant gas R-41
2455	116	Methyl nitrite
2456	130P	2-Chloropropene
2457	128	2,3-Dimethylbutane
2458	130	Hexadiene
2459	128	2-Methyl-1-butene
2460	128	2-Methyl-2-butene
2461	128	Methylpentadiene
2463	138	Aluminum hydride
2464	141	Beryllium nitrate
2465	140	Dichloroisocyanuric acid, dry
2465	140	Dichloroisocyanuric acid salts
2465	140	Sodium dichloroisocyanurate
2465	140	Sodium dichloro-s-triazinetrione
2466	143	Potassium superoxide
2468	140	Trichloroisocyanuric acid, dry
2469	140	Zinc bromate
2470	152	Phenylacetoneitrile, liquid
2471	154	Osmium tetroxide
2473	154	Sodium arsenilate
2474	157	Thiophosgene
2475	157	Vanadium trichloride
2477	131	Methyl isothiocyanate
2478	155	Isocyanate solution, flammable, poisonous, n.o.s.
2478	155	Isocyanate solution, flammable, toxic, n.o.s.
2478	155	Isocyanates, flammable, poisonous, n.o.s.

**ID Guide Name of Material
No. No.**

2478	155	Isocyanates, flammable, toxic, n.o.s.
2480	155P	Methyl isocyanate
2481	155	Ethyl isocyanate
2482	155P	n-Propyl isocyanate
2483	155P	Isopropyl isocyanate
2484	155	tert-Butyl isocyanate
2485	155P	n-Butyl isocyanate
2486	155P	Isobutyl isocyanate
2487	155	Phenyl isocyanate
2488	155	Cyclohexyl isocyanate
2490	153	Dichloroisopropyl ether
2491	153	Ethanolamine
2491	153	Ethanolamine, solution
2491	153	Monoethanolamine
2493	132	Hexamethyleneimine
2495	144	Iodine pentafluoride
2496	156	Propionic anhydride
2498	129	1,2,3,6-Tetrahydrobenzaldehyde
2501	152	Tris-(1-aziridinyl)phosphine oxide, solution
2502	132	Valeryl chloride
2503	137	Zirconium tetrachloride
2504	159	Acetylene tetrabromide
2504	159	Tetrabromoethane
2505	154	Ammonium fluoride
2506	154	Ammonium hydrogen sulfate
2506	154	Ammonium hydrogen sulphate
2507	154	Chloroplatinic acid, solid
2508	156	Molybdenum pentachloride
2509	154	Potassium hydrogen sulfate
2509	154	Potassium hydrogen sulphate

**ID Guide Name of Material
No. No.**

2511	153	2-Chloropropionic acid
2512	152	Aminophenols
2513	156	Bromoacetyl bromide
2514	130	Bromobenzene
2515	159	Bromoform
2516	151	Carbon tetrabromide
2517	115	1-Chloro-1,1-difluoroethane
2517	115	Difluorochloroethanes
2517	115	Refrigerant gas R-142b
2518	153	1,5,9-Cyclododecatiene
2520	130P	Cyclooctadienes
2521	131P	Diketene, stabilized
2522	153P	2-Dimethylaminoethyl methacrylate
2524	129	Ethyl orthoformate
2525	156	Ethyl oxalate
2526	132	Furfurylamine
2527	129P	Isobutyl acrylate, stabilized
2528	130	Isobutyl isobutyrate
2529	132	Isobutyric acid
2531	153P	Methacrylic acid, stabilized
2533	156	Methyl trichloroacetate
2534	119	Methylchlorosilane
2535	132	4-Methylmorpholine
2535	132	N-Methylmorpholine
2536	127	Methyltetrahydrofuran
2538	133	Nitronaphthalene
2541	128	Terpinolene
2542	153	Tributylamine
2545	135	Hafnium powder, dry
2546	135	Titanium powder, dry
2547	143	Sodium superoxide

ID Guide Name of Material
No. No.

2548	124	Chlorine pentafluoride
2552	151	Hexafluoroacetone hydrate, liquid
2554	130P	Methylallyl chloride
2555	113	Nitrocellulose with water, not less than 25% water
2556	113	Nitrocellulose with alcohol, not less than 25% alcohol
2557	133	Nitrocellulose mixture, without pigment
2557	133	Nitrocellulose mixture, without plasticizer
2557	133	Nitrocellulose mixture, with pigment
2557	133	Nitrocellulose mixture, with plasticizer
2558	131	Epibromohydrin
2560	129	2-Methylpentan-2-ol
2561	128	3-Methyl-1-butene
2564	153	Trichloroacetic acid, solution
2565	153	Dicyclohexylamine
2567	154	Sodium pentachlorophenate
2570	154	Cadmium compound
2571	156	Alkylsulfuric acids
2571	156	Alkylsulphuric acids
2572	153	Phenylhydrazine
2573	141	Thallium chlorate
2574	151	Tricresyl phosphate
2576	137	Phosphorus oxybromide, molten
2577	156	Phenylacetyl chloride
2578	157	Phosphorus trioxide
2579	153	Piperazine
2580	154	Aluminum bromide, solution
2581	154	Aluminum chloride, solution

ID Guide Name of Material
No. No.

2582	154	Ferric chloride, solution
2583	153	Alkyl sulfonic acids, solid, with more than 5% free Sulfuric acid
2583	153	Alkyl sulphonic acids, solid, with more than 5% free Sulphuric acid
2583	153	Aryl sulfonic acids, solid, with more than 5% free Sulfuric acid
2583	153	Aryl sulphonic acids, solid, with more than 5% free Sulphuric acid
2584	153	Alkyl sulfonic acids, liquid, with more than 5% free Sulfuric acid
2584	153	Alkyl sulphonic acids, liquid, with more than 5% free Sulphuric acid
2584	153	Aryl sulfonic acids, liquid, with more than 5% free Sulfuric acid
2584	153	Aryl sulphonic acids, liquid, with more than 5% free Sulphuric acid
2585	153	Alkyl sulfonic acids, solid, with not more than 5% free Sulfuric acid
2585	153	Alkyl sulphonic acids, solid, with not more than 5% free Sulphuric acid
2585	153	Aryl sulfonic acids, solid, with not more than 5% free Sulfuric acid
2585	153	Aryl sulphonic acids, solid, with not more than 5% free Sulphuric acid
2586	153	Alkyl sulfonic acids, liquid, with not more than 5% free Sulfuric acid
2586	153	Alkyl sulphonic acids, liquid, with not more than 5% free Sulphuric acid

ID Guide Name of Material
No. No.

2586	153	Aryl sulfonic acids, liquid, with not more than 5% free Sulfuric acid
2586	153	Aryl sulphonic acids, liquid, with not more than 5% free Sulphuric acid
2587	153	Benzoquinone
2588	151	Pesticide, solid, poisonous, n.o.s.
2588	151	Pesticide, solid, toxic, n.o.s.
2589	155	Vinyl chloroacetate
2590	171	Asbestos, chrysotile
2590	171	Asbestos, white
2590	171	White asbestos
2591	120	Xenon, refrigerated liquid (cryogenic liquid)
2599	126	Chlorotrifluoromethane and Trifluoromethane azeotropic mixture with approximately 60% Chlorotrifluoromethane
2599	126	Refrigerant gas R-503
2599	126	Trifluoromethane and Chlorotrifluoromethane azeotropic mixture with approximately 60% Chlorotrifluoromethane
2601	115	Cyclobutane
2602	126	Dichlorodifluoromethane and Difluoroethane azeotropic mixture with approximately 74% Dichlorodifluoromethane
2602	126	Difluoroethane and Dichlorodifluoromethane azeotropic mixture with approximately 74% Dichlorodifluoromethane
2602	126	Refrigerant gas R-500
2603	131	Cycloheptatriene
2604	132	Boron trifluoride diethyl etherate

ID Guide Name of Material
No. No.

2605	155	Methoxymethyl isocyanate
2606	155	Methyl orthosilicate
2607	129P	Acrolein dimer, stabilized
2608	129	Nitropropanes
2609	156	Triallyl borate
2610	132	Triallylamine
2611	131	Propylene chlorohydrin
2612	127	Methyl propyl ether
2614	129	Methallyl alcohol
2615	127	Ethyl propyl ether
2616	129	Triisopropyl borate
2617	129	Methylcyclohexanols
2618	130P	Vinyltoluenes, stabilized
2619	132	Benzyl dimethylamine
2620	130	Amyl butyrates
2621	127	Acetyl methyl carbinol
2622	131P	Glycidaldehyde
2623	133	Firelighters, solid, with flammable liquid
2624	138	Magnesium silicide
2626	140	Chloric acid, aqueous solution, with not more than 10% Chloric acid
2627	140	Nitrites, inorganic, n.o.s.
2628	151	Potassium fluoroacetate
2629	151	Sodium fluoroacetate
2630	151	Selenates
2630	151	Selenites
2642	154	Fluoroacetic acid
2643	155	Methyl bromoacetate
2644	151	Methyl iodide
2645	153	Phenacyl bromide

ID Guide Name of Material
No. No.

ID Guide Name of Material
No. No.

2646 **151** Hexachlorocyclopentadiene
2647 **153** Malononitrile
2648 **154** 1,2-Dibromobutan-3-one
2649 **153** 1,3-Dichloroacetone
2650 **153** 1,1-Dichloro-1-nitroethane
2651 **153** 4,4'-Diaminodiphenylmethane
2653 **156** Benzyl iodide
2655 **151** Potassium fluorosilicate
2656 **154** Quinoline
2657 **153** Selenium disulfide
2657 **153** Selenium disulphide
2659 **151** Sodium chloroacetate
2660 **153** Mononitrotoluidines
2660 **153** Nitrotoluidines (mono)
2661 **153** Hexachloroacetone
2664 **160** Dibromomethane
2667 **152** Butyltoluenes
2668 **131** Chloroacetonitrile
2669 **152** Chlorocresols, solution
2670 **157** Cyanuric chloride
2671 **153** Aminopyridines
2672 **154** Ammonia, solution, with more than 10% but not more than 35% Ammonia
2672 **154** Ammonium hydroxide
2672 **154** Ammonium hydroxide, with more than 10% but not more than 35% Ammonia
2673 **151** 2-Amino-4-chlorophenol
2674 **154** Sodium fluorosilicate
2676 **119** Stibine
2677 **154** Rubidium hydroxide, solution
2678 **154** Rubidium hydroxide, solid

2679 **154** Lithium hydroxide, solution
2680 **154** Lithium hydroxide
2681 **154** Caesium hydroxide, solution
2681 **154** Cesium hydroxide, solution
2682 **157** Caesium hydroxide
2682 **157** Cesium hydroxide
2683 **132** Ammonium sulfide, solution
2683 **132** Ammonium sulphide, solution
2684 **132** 3-Diethylaminopropylamine
2685 **132** N,N-Diethylethylenediamine
2686 **132** 2-Diethylaminoethanol
2687 **133** Dicyclohexylammonium nitrite
2688 **159** 1-Bromo-3-chloropropane
2689 **153** Glycerol alpha-monochlorohydrin
2690 **152** N,n-Butylimidazole
2691 **137** Phosphorus pentabromide
2692 **157** Boron tribromide
2693 **154** Bisulfites, aqueous solution, n.o.s.
2693 **154** Bisulphites, aqueous solution, n.o.s.
2698 **156** Tetrahydrophthalic anhydrides
2699 **154** Trifluoroacetic acid
2705 **153P** 1-Pentol
2707 **127** Dimethyldioxanes
2709 **128** Butylbenzenes
2710 **128** Dipropyl ketone
2713 **153** Acridine
2714 **133** Zinc resinate
2715 **133** Aluminum resinate
2716 **153** 1,4-Butynediol

**ID Guide Name of Material
No. No.**

2717	133	Camphor, synthetic
2719	141	Barium bromate
2720	141	Chromium nitrate
2721	140	Copper chlorate
2722	140	Lithium nitrate
2723	140	Magnesium chlorate
2724	140	Manganese nitrate
2725	140	Nickel nitrate
2726	140	Nickel nitrite
2727	141	Thallium nitrate
2728	140	Zirconium nitrate
2729	152	Hexachlorobenzene
2730	152	Nitroanisoles, liquid
2732	152	Nitrobromobenzenes, liquid
2733	132	Amines, flammable, corrosive, n.o.s.
2733	132	Polyamines, flammable, corrosive, n.o.s.
2734	132	Amines, liquid, corrosive, flammable, n.o.s.
2734	132	Polyamines, liquid, corrosive, flammable, n.o.s.
2735	153	Amines, liquid, corrosive, n.o.s.
2735	153	Polyamines, liquid, corrosive, n.o.s.
2738	153	N-Butylaniline
2739	156	Butyric anhydride
2740	155	n-Propyl chloroformate
2741	141	Barium hypochlorite, with more than 22% available Chlorine
2742	155	sec-Butyl chloroformate
2742	155	Chloroformates, poisonous, corrosive, flammable, n.o.s.

**ID Guide Name of Material
No. No.**

2742	155	Chloroformates, toxic, corrosive, flammable, n.o.s.
2742	155	Isobutyl chloroformate
2743	155	n-Butyl chloroformate
2744	155	Cyclobutyl chloroformate
2745	157	Chloromethyl chloroformate
2746	156	Phenyl chloroformate
2747	156	tert-Butylcyclohexyl chloroformate
2748	156	2-Ethylhexyl chloroformate
2749	130	Tetramethylsilane
2750	153	1,3-Dichloropropanol-2
2751	155	Diethylthiophosphoryl chloride
2752	127	1,2-Epoxy-3-ethoxypropane
2753	153	N-Ethylbenzyltoluidines, liquid
2754	153	N-Ethyltoluidines
2757	151	Carbamate pesticide, solid, poisonous
2757	151	Carbamate pesticide, solid, toxic
2758	131	Carbamate pesticide, liquid, flammable, poisonous
2758	131	Carbamate pesticide, liquid, flammable, toxic
2759	151	Arsenical pesticide, solid, poisonous
2759	151	Arsenical pesticide, solid, toxic
2760	131	Arsenical pesticide, liquid, flammable, poisonous
2760	131	Arsenical pesticide, liquid, flammable, toxic
2761	151	Organochlorine pesticide, solid, poisonous
2761	151	Organochlorine pesticide, solid, toxic

**ID Guide Name of Material
No. No.**

2762	131	Organochlorine pesticide, liquid, flammable, poisonous
2762	131	Organochlorine pesticide, liquid, flammable, toxic
2763	151	Triazine pesticide, solid, poisonous
2763	151	Triazine pesticide, solid, toxic
2764	131	Triazine pesticide, liquid, flammable, poisonous
2764	131	Triazine pesticide, liquid, flammable, toxic
2771	151	Thiocarbamate pesticide, solid, poisonous
2771	151	Thiocarbamate pesticide, solid, toxic
2772	131	Thiocarbamate pesticide, liquid, flammable, poisonous
2772	131	Thiocarbamate pesticide, liquid, flammable, toxic
2775	151	Copper based pesticide, solid, poisonous
2775	151	Copper based pesticide, solid, toxic
2776	131	Copper based pesticide, liquid, flammable, poisonous
2776	131	Copper based pesticide, liquid, flammable, toxic
2777	151	Mercury based pesticide, solid, poisonous
2777	151	Mercury based pesticide, solid, toxic
2778	131	Mercury based pesticide, liquid, flammable, poisonous
2778	131	Mercury based pesticide, liquid, flammable, toxic
2779	153	Substituted nitrophenol pesticide, solid, poisonous
2779	153	Substituted nitrophenol pesticide, solid, toxic

**ID Guide Name of Material
No. No.**

2780	131	Substituted nitrophenol pesticide, liquid, flammable, poisonous
2780	131	Substituted nitrophenol pesticide, liquid, flammable, toxic
2781	151	Bipyridilium pesticide, solid, poisonous
2781	151	Bipyridilium pesticide, solid, toxic
2782	131	Bipyridilium pesticide, liquid, flammable, poisonous
2782	131	Bipyridilium pesticide, liquid, flammable, toxic
2783	152	Organophosphorus pesticide, solid, poisonous
2783	152	Organophosphorus pesticide, solid, toxic
2784	131	Organophosphorus pesticide, liquid, flammable, poisonous
2784	131	Organophosphorus pesticide, liquid, flammable, toxic
2785	152	4-Thiapentanal
2786	153	Organotin pesticide, solid, poisonous
2786	153	Organotin pesticide, solid, toxic
2787	131	Organotin pesticide, liquid, flammable, poisonous
2787	131	Organotin pesticide, liquid, flammable, toxic
2788	153	Organotin compound, liquid, n.o.s.
2789	132	Acetic acid, glacial
2789	132	Acetic acid, solution, more than 80% acid
2790	153	Acetic acid, solution, more than 10% but not more than 80% acid

ID Guide Name of Material
No. No.

2793 **170** Ferrous metal borings, shavings, turnings or cuttings
2794 **154** Batteries, wet, filled with acid
2795 **154** Batteries, wet, filled with alkali
2796 **157** Battery fluid, acid
2796 **157** Sulfuric acid, with not more than 51% acid
2796 **157** Sulphuric acid, with not more than 51% acid
2797 **154** Battery fluid, alkali
2798 **137** Benzene phosphorus dichloride
2798 **137** Phenylphosphorus dichloride
2799 **137** Benzene phosphorus thiodichloride
2799 **137** Phenylphosphorus thiodichloride
2800 **154** Batteries, wet, non-spillable
2801 **154** Dye, liquid, corrosive, n.o.s.
2801 **154** Dye intermediate, liquid, corrosive, n.o.s.
2802 **154** Copper chloride
2803 **172** Gallium
2805 **138** Lithium hydride, fused solid
2806 **139** Lithium nitride
2807 **171** Magnetized material
2809 **172** Mercury
2810 **153** Compounds, tree or weed killing, liquid (toxic)
2810 **153** Poisonous liquid, organic, n.o.s.
2810 **153** Toxic liquid, organic, n.o.s.
2811 **154** Poisonous solid, organic, n.o.s.
2811 **154** Toxic solid, organic, n.o.s.
2812 **154** Sodium aluminate, solid
2813 **138** Water-reactive solid, n.o.s.

ID Guide Name of Material
No. No.

2814 **158** Infectious substance, affecting humans
2815 **153** N-Aminoethylpiperazine
2817 **154** Ammonium bifluoride, solution
2817 **154** Ammonium hydrogendifluoride, solution
2818 **154** Ammonium polysulfide, solution
2818 **154** Ammonium polysulphide, solution
2819 **153** Amyl acid phosphate
2820 **153** Butyric acid
2821 **153** Phenol solution
2822 **153** 2-Chloropyridine
2823 **153** Crotonic acid, solid
2826 **155** Ethyl chlorothioformate
2829 **153** Caproic acid
2829 **153** Hexanoic acid
2830 **139** Lithium ferrosilicon
2831 **160** 1,1,1-Trichloroethane
2834 **154** Phosphorous acid
2835 **138** Sodium aluminum hydride
2837 **154** Bisulfates, aqueous solution
2837 **154** Bisulphates, aqueous solution
2837 **154** Sodium bisulfate, solution
2837 **154** Sodium bisulphate, solution
2838 **129P** Vinyl butyrate, stabilized
2839 **153** Aldol
2840 **129** Butyraldoxime
2841 **131** Di-n-amylamine
2842 **129** Nitroethane
2844 **138** Calcium manganese silicon
2845 **135** Ethyl phosphonous dichloride, anhydrous

ID Guide Name of Material
No. No.

ID Guide Name of Material
No. No.

2845	135	Methyl phosphonous dichloride
2845	135	Pyrophoric liquid, organic, n.o.s.
2846	135	Pyrophoric solid, organic, n.o.s.
2849	153	3-Chloropropanol-1
2850	128	Propylene tetramer
2851	157	Boron trifluoride, dihydrate
2852	113	Dipicryl sulfide, wetted with not less than 10% water
2852	113	Dipicryl sulphide, wetted with not less than 10% water
2853	151	Magnesium fluorosilicate
2854	151	Ammonium fluorosilicate
2854	151	Ammonium silicofluoride
2855	151	Zinc fluorosilicate
2855	151	Zinc silicofluoride
2856	151	Fluorosilicates, n.o.s.
2857	126	Refrigerating machines, containing Ammonia solutions (UN2672)
2857	126	Refrigerating machines, containing non-flammable, non-poisonous gases
2857	126	Refrigerating machines, containing non-flammable, non-toxic gases
2858	170	Zirconium, dry, coiled wire, finished metal sheets or strip
2859	154	Ammonium metavanadate
2861	151	Ammonium polyvanadate
2862	151	Vanadium pentoxide
2863	154	Sodium ammonium vanadate
2864	151	Potassium metavanadate
2865	154	Hydroxylamine sulfate
2865	154	Hydroxylamine sulphate

2869	157	Titanium trichloride mixture
2870	135	Aluminum borohydride
2870	135	Aluminum borohydride in devices
2871	170	Antimony powder
2872	159	Dibromochloropropanes
2873	153	Dibutylaminoethanol
2874	153	Furfuryl alcohol
2875	151	Hexachlorophene
2876	153	Resorcinol
2878	170	Titanium sponge granules
2878	170	Titanium sponge powders
2879	157	Selenium oxychloride
2880	140	Calcium hypochlorite, hydrated, with not less than 5.5% but not more than 16% water
2880	140	Calcium hypochlorite, hydrated mixture, with not less than 5.5% but not more than 16% water
2881	135	Metal catalyst, dry
2881	135	Nickel catalyst, dry
2900	158	Infectious substance, affecting animals only
2901	124	Bromine chloride
2902	151	Pesticide, liquid, poisonous, n.o.s.
2902	151	Pesticide, liquid, toxic, n.o.s.
2903	131	Pesticide, liquid, poisonous, flammable, n.o.s.
2903	131	Pesticide, liquid, toxic, flammable, n.o.s.
2904	154	Chlorophenolates, liquid
2904	154	Phenolates, liquid
2905	154	Chlorophenolates, solid

**ID Guide Name of Material
No. No.**

2905	154	Phenolates, solid
2907	133	Isosorbide dinitrate mixture
2908	161	Radioactive material, excepted package, empty packaging
2909	161	Radioactive material, excepted package, articles manufactured from depleted Uranium
2909	161	Radioactive material, excepted package, articles manufactured from natural Thorium
2909	161	Radioactive material, excepted package, articles manufactured from natural Uranium
2910	161	Radioactive material, excepted package, limited quantity of material
2911	161	Radioactive material, excepted package, articles
2911	161	Radioactive material, excepted package, instruments
2912	162	Radioactive material, low specific activity (LSA-I), non fissile or fissile-excepted
2913	162	Radioactive material, surface contaminated objects (SCO-I), non fissile or fissile-excepted
2913	162	Radioactive material, surface contaminated objects (SCO-II), non fissile or fissile-excepted
2915	163	Radioactive material, Type A package, non-special form, non fissile or fissile-excepted
2916	163	Radioactive material, Type B(U) package, non fissile or fissile-excepted
2917	163	Radioactive material, Type B(M) package, non fissile or fissile-excepted

**ID Guide Name of Material
No. No.**

2919	163	Radioactive material, transported under special arrangement, non fissile or fissile-excepted
2920	132	Corrosive liquid, flammable, n.o.s.
2921	134	Corrosive solid, flammable, n.o.s.
2922	154	Corrosive liquid, poisonous, n.o.s.
2922	154	Corrosive liquid, toxic, n.o.s.
2923	154	Corrosive solid, poisonous, n.o.s.
2923	154	Corrosive solid, toxic, n.o.s.
2924	132	Flammable liquid, corrosive, n.o.s
2925	134	Flammable solid, corrosive, organic, n.o.s.
2926	134	Flammable solid, poisonous, organic, n.o.s.
2926	134	Flammable solid, toxic, organic, n.o.s.
2927	154	Ethyl phosphonothioic dichloride, anhydrous
2927	154	Ethyl phosphorodichloridate
2927	154	Poisonous liquid, corrosive, organic, n.o.s.
2927	154	Toxic liquid, corrosive, organic, n.o.s.
2928	154	Poisonous solid, corrosive, organic, n.o.s.
2928	154	Toxic solid, corrosive, organic, n.o.s.
2929	131	Poisonous liquid, flammable, organic, n.o.s.
2929	131	Toxic liquid, flammable, organic, n.o.s.
2930	134	Poisonous solid, flammable, organic, n.o.s.

ID Guide Name of Material
No. No.

ID Guide Name of Material
No. No.

2930 **134** Toxic solid, flammable, organic, n.o.s.

2931 **151** Vanadyl sulfate

2931 **151** Vanadyl sulphate

2933 **129** Methyl 2-chloropropionate

2934 **129** Isopropyl 2-chloropropionate

2935 **129** Ethyl 2-chloropropionate

2936 **153** Thiolactic acid

2937 **153** alpha-Methylbenzyl alcohol, liquid

2937 **153** Methylbenzyl (alpha) alcohol, liquid

2940 **135** Cyclooctadiene phosphines

2940 **135** 9-Phosphabicyclononanes

2941 **153** Fluoroanilines

2942 **153** 2-Trifluoromethylaniline

2943 **129** Tetrahydrofurfurylamine

2945 **132** N-Methylbutylamine

2946 **153** 2-Amino-5-diethylaminopentane

2947 **155** Isopropyl chloroacetate

2948 **153** 3-Trifluoromethylaniline

2949 **154** Sodium hydrosulfide, hydrated, with not less than 25% water of crystallization

2949 **154** Sodium hydrosulfide, with not less than 25% water of crystallization

2949 **154** Sodium hydrosulphide, hydrated, with not less than 25% water of crystallization

2949 **154** Sodium hydrosulphide, with not less than 25% water of crystallization

2950 **138** Magnesium granules, coated

2956 **149** 5-tert-Butyl-2,4,6-trinitro-m-xylene

2956 **149** Musk xylene

2965 **139** Boron trifluoride dimethyl etherate

2966 **153** Thioglycol

2967 **154** Sulfamic acid

2967 **154** Sulphamic acid

2968 **135** Maneb, stabilized

2968 **135** Maneb preparation, stabilized

2969 **171** Castor beans, meal, pomace or flake

2977 **166** Radioactive material, Uranium hexafluoride, fissile

2977 **166** Uranium hexafluoride, radioactive material, fissile

2978 **166** Radioactive material, Uranium hexafluoride, non fissile or fissile-excepted

2978 **166** Uranium hexafluoride, radioactive material, non fissile or fissile-excepted

2983 **131P** Ethylene oxide and Propylene oxide mixture, with not more than 30% Ethylene oxide

2983 **131P** Propylene oxide and Ethylene oxide mixture, with not more than 30% Ethylene oxide

2984 **140** Hydrogen peroxide, aqueous solution, with not less than 8% but less than 20% Hydrogen peroxide

2985 **155** Chlorosilanes, flammable, corrosive, n.o.s.

2986 **155** Chlorosilanes, corrosive, flammable, n.o.s.

2987 **156** Chlorosilanes, corrosive, n.o.s.

2988 **139** Chlorosilanes, water-reactive, flammable, corrosive, n.o.s.

2989 **133** Lead phosphite, dibasic

ID Guide Name of Material
No. No.

2990	171	Life-saving appliances, self-inflating
2991	131	Carbamate pesticide, liquid, poisonous, flammable
2991	131	Carbamate pesticide, liquid, toxic, flammable
2992	151	Carbamate pesticide, liquid, poisonous
2992	151	Carbamate pesticide, liquid, toxic
2993	131	Arsenical pesticide, liquid, poisonous, flammable
2993	131	Arsenical pesticide, liquid, toxic, flammable
2994	151	Arsenical pesticide, liquid, poisonous
2994	151	Arsenical pesticide, liquid, toxic
2995	131	Organochlorine pesticide, liquid, poisonous, flammable
2995	131	Organochlorine pesticide, liquid, toxic, flammable
2996	151	Organochlorine pesticide, liquid, poisonous
2996	151	Organochlorine pesticide, liquid, toxic
2997	131	Triazine pesticide, liquid, poisonous, flammable
2997	131	Triazine pesticide, liquid, toxic, flammable
2998	151	Triazine pesticide, liquid, poisonous
2998	151	Triazine pesticide, liquid, toxic
3002	151	Phenyl urea pesticide, liquid, poisonous
3002	151	Phenyl urea pesticide, liquid, toxic
3005	131	Thiocarbamate pesticide, liquid, poisonous, flammable

ID Guide Name of Material
No. No.

3005	131	Thiocarbamate pesticide, liquid, toxic, flammable
3006	151	Thiocarbamate pesticide, liquid, poisonous
3006	151	Thiocarbamate pesticide, liquid, toxic
3009	131	Copper based pesticide, liquid, poisonous, flammable
3009	131	Copper based pesticide, liquid, toxic, flammable
3010	151	Copper based pesticide, liquid, poisonous
3010	151	Copper based pesticide, liquid, toxic
3011	131	Mercury based pesticide, liquid, poisonous, flammable
3011	131	Mercury based pesticide, liquid, toxic, flammable
3012	151	Mercury based pesticide, liquid, poisonous
3012	151	Mercury based pesticide, liquid, toxic
3013	131	Substituted nitrophenol pesticide, liquid, poisonous, flammable
3013	131	Substituted nitrophenol pesticide, liquid, toxic, flammable
3014	153	Substituted nitrophenol pesticide, liquid, poisonous
3014	153	Substituted nitrophenol pesticide, liquid, toxic
3015	131	Bipyridilium pesticide, liquid, poisonous, flammable
3015	131	Bipyridilium pesticide, liquid, toxic, flammable
3016	151	Bipyridilium pesticide, liquid, poisonous
3016	151	Bipyridilium pesticide, liquid, toxic

ID Guide Name of Material
No. No.

ID Guide Name of Material
No. No.

3017 **131** Organophosphorus pesticide,
liquid, poisonous, flammable

3017 **131** Organophosphorus pesticide,
liquid, toxic, flammable

3018 **152** Organophosphorus pesticide,
liquid, poisonous

3018 **152** Organophosphorus pesticide,
liquid, toxic

3019 **131** Organotin pesticide, liquid,
poisonous, flammable

3019 **131** Organotin pesticide, liquid,
toxic, flammable

3020 **153** Organotin pesticide, liquid,
poisonous

3020 **153** Organotin pesticide, liquid, toxic

3021 **131** Pesticide, liquid, flammable,
poisonous, n.o.s.

3021 **131** Pesticide, liquid, flammable,
toxic, n.o.s.

3022 **127P** 1,2-Butylene oxide, stabilized

3023 131 2-Methyl-2-heptanethiol

3024 **131** Coumarin derivative pesticide,
liquid, flammable, poisonous

3024 **131** Coumarin derivative pesticide,
liquid, flammable, toxic

3025 **131** Coumarin derivative pesticide,
liquid, poisonous, flammable

3025 **131** Coumarin derivative pesticide,
liquid, toxic, flammable

3026 **151** Coumarin derivative pesticide,
liquid, poisonous

3026 **151** Coumarin derivative pesticide,
liquid, toxic

3027 **151** Coumarin derivative pesticide,
solid, poisonous

3027 **151** Coumarin derivative pesticide,
solid, toxic

3028 **154** Batteries, dry, containing
Potassium hydroxide solid

3048 157 Aluminum phosphide pesticide

3051 **135** Aluminum alkyls

3053 **135** Magnesium alkyls

3054 **129** Cyclohexanethiol

3054 **129** Cyclohexyl mercaptan

3055 **154** 2-(2-Aminoethoxy)ethanol

3056 **129** n-Heptaldehyde

3057 125 Trifluoroacetyl chloride

3064 **127** Nitroglycerin, solution in
alcohol, with more than
1% but not more than 5%
Nitroglycerin

3065 **127** Alcoholic beverages

3066 **153** Paint (corrosive)

3066 **153** Paint related material
(corrosive)

3070 **126** Dichlorodifluoromethane and
Ethylene oxide mixture,
with not more than 12.5%
Ethylene oxide

3070 **126** Ethylene oxide and
Dichlorodifluoromethane
mixture, with not more than
12.5% Ethylene oxide

3071 **131** Mercaptan mixture, liquid,
poisonous, flammable, n.o.s.

3071 **131** Mercaptan mixture, liquid, toxic,
flammable, n.o.s.

3071 **131** Mercaptans, liquid, poisonous,
flammable, n.o.s.

3071 **131** Mercaptans, liquid, toxic,
flammable, n.o.s.

3072 **171** Life-saving appliances, not self-
inflating

3073 **131P** Vinylpyridines, stabilized

3076 **138** Aluminum alkyl hydrides

3077 **171** Environmentally hazardous
substance, solid, n.o.s.

**ID Guide Name of Material
No. No.**

3077	171	Hazardous waste, solid, n.o.s.
3077	171	Other regulated substances, solid, n.o.s.
3078	138	Cerium, turnings or gritty powder
3079	131P	Methacrylonitrile, stabilized
3080	155	Isocyanate solution, poisonous, flammable, n.o.s.
3080	155	Isocyanate solution, toxic, flammable, n.o.s.
3080	155	Isocyanates, poisonous, flammable, n.o.s.
3080	155	Isocyanates, toxic, flammable, n.o.s.
3082	171	Environmentally hazardous substance, liquid, n.o.s.
3082	171	Hazardous waste, liquid, n.o.s.
3082	171	Other regulated substances, liquid, n.o.s.
3083	124	Perchloryl fluoride
3084	157	Corrosive solid, oxidizing, n.o.s.
3085	140	Oxidizing solid, corrosive, n.o.s.
3086	141	Poisonous solid, oxidizing, n.o.s.
3086	141	Toxic solid, oxidizing, n.o.s.
3087	141	Oxidizing solid, poisonous, n.o.s.
3087	141	Oxidizing solid, toxic, n.o.s.
3088	135	Self-heating solid, organic, n.o.s.
3089	170	Metal powder, flammable, n.o.s.
3090	138	Lithium batteries
3090	138	Lithium metal batteries (including lithium alloy batteries)
3091	138	Lithium batteries contained in equipment

**ID Guide Name of Material
No. No.**

3091	138	Lithium batteries packed with equipment
3091	138	Lithium metal batteries contained in equipment (including lithium alloy batteries)
3091	138	Lithium metal batteries packed with equipment (including lithium alloy batteries)
3092	129	1-Methoxy-2-propanol
3093	157	Corrosive liquid, oxidizing, n.o.s.
3094	138	Corrosive liquid, water-reactive, n.o.s.
3095	136	Corrosive solid, self-heating, n.o.s.
3096	138	Corrosive solid, water-reactive, n.o.s.
3097	140	Flammable solid, oxidizing, n.o.s.
3098	140	Oxidizing liquid, corrosive, n.o.s.
3099	142	Oxidizing liquid, poisonous, n.o.s.
3099	142	Oxidizing liquid, toxic, n.o.s.
3100	135	Oxidizing solid, self-heating, n.o.s.
3101	146	Organic peroxide type B, liquid
3102	146	Organic peroxide type B, solid
3103	146	Organic peroxide type C, liquid
3104	146	Organic peroxide type C, solid
3105	145	Organic peroxide type D, liquid
3106	145	Organic peroxide type D, solid
3107	145	Organic peroxide type E, liquid
3108	145	Organic peroxide type E, solid
3109	145	Organic peroxide type F, liquid
3110	145	Organic peroxide type F, solid

ID Guide Name of Material
No. No.

3111	148	Organic peroxide type B, liquid, temperature controlled
3112	148	Organic peroxide type B, solid, temperature controlled
3113	148	Organic peroxide type C, liquid, temperature controlled
3114	148	Organic peroxide type C, solid, temperature controlled
3115	148	Organic peroxide type D, liquid, temperature controlled
3116	148	Organic peroxide type D, solid, temperature controlled
3117	148	Organic peroxide type E, liquid, temperature controlled
3118	148	Organic peroxide type E, solid, temperature controlled
3119	148	Organic peroxide type F, liquid, temperature controlled
3120	148	Organic peroxide type F, solid, temperature controlled
3121	144	Oxidizing solid, water-reactive, n.o.s.
3122	142	Poisonous liquid, oxidizing, n.o.s.
3122	142	Toxic liquid, oxidizing, n.o.s.
3123	139	Poisonous liquid, water-reactive, n.o.s.
3123	139	Toxic liquid, water-reactive, n.o.s.
3124	136	Poisonous solid, self-heating, n.o.s.
3124	136	Toxic solid, self-heating, n.o.s.
3125	139	Poisonous solid, water-reactive, n.o.s.
3125	139	Toxic solid, water-reactive, n.o.s.
3126	136	Self-heating solid, corrosive, organic, n.o.s.

ID Guide Name of Material
No. No.

3127	135	Self-heating solid, oxidizing, n.o.s.
3128	136	Self-heating solid, poisonous, organic, n.o.s.
3128	136	Self-heating solid, toxic, organic, n.o.s.
3129	138	Water-reactive liquid, corrosive, n.o.s.
3130	139	Water-reactive liquid, poisonous, n.o.s.
3130	139	Water-reactive liquid, toxic, n.o.s.
3131	138	Water-reactive solid, corrosive, n.o.s.
3132	138	Water-reactive solid, flammable, n.o.s.
3133	138	Water-reactive solid, oxidizing, n.o.s.
3134	139	Water-reactive solid, poisonous, n.o.s.
3134	139	Water-reactive solid, toxic, n.o.s.
3135	138	Water-reactive solid, self-heating, n.o.s.
3136	120	Trifluoromethane, refrigerated liquid
3137	140	Oxidizing solid, flammable, n.o.s.
3138	115	Acetylene, Ethylene and Propylene in mixture, refrigerated liquid containing at least 71.5% Ethylene with not more than 22.5% Acetylene and not more than 6% Propylene
3138	115	Ethylene, Acetylene and Propylene in mixture, refrigerated liquid containing at least 71.5% Ethylene with not more than 22.5% Acetylene and not more than 6% Propylene

**ID Guide Name of Material
No. No.**

- 3138 **115** Propylene, Ethylene and Acetylene in mixture, refrigerated liquid containing at least 71.5% Ethylene with not more than 22.5% Acetylene and not more than 6% Propylene
- 3139 **140** Oxidizing liquid, n.o.s.
- 3140 **151** Alkaloids, liquid, n.o.s. (poisonous)
- 3140 **151** Alkaloid salts, liquid, n.o.s. (poisonous)
- 3141 **157** Antimony compound, inorganic, liquid, n.o.s.
- 3142 **151** Disinfectant, liquid, poisonous, n.o.s.
- 3142 **151** Disinfectant, liquid, toxic, n.o.s.
- 3143 **151** Dye, solid, poisonous, n.o.s.
- 3143 **151** Dye, solid, toxic, n.o.s.
- 3143 **151** Dye intermediate, solid, poisonous, n.o.s.
- 3143 **151** Dye intermediate, solid, toxic, n.o.s.
- 3144 **151** Nicotine compound, liquid, n.o.s.
- 3144 **151** Nicotine preparation, liquid, n.o.s.
- 3145 **153** Alkylphenols, liquid, n.o.s. (including C2-C12 homologues)
- 3146 **153** Organotin compound, solid, n.o.s.
- 3147 **154** Dye, solid, corrosive, n.o.s.
- 3147 **154** Dye intermediate, solid, corrosive, n.o.s.
- 3148 **138** Water-reactive liquid, n.o.s.

**ID Guide Name of Material
No. No.**

- 3149 **140** Hydrogen peroxide and Peroxyacetic acid mixture, with acid(s), water and not more than 5% Peroxyacetic acid, stabilized
- 3149 **140** Peroxyacetic acid and hydrogen peroxide mixture, with acid(s), water and not more than 5% Peroxyacetic acid, stabilized
- 3150 **115** Devices, small, hydrocarbon gas powered, with release device
- 3150 **115** Hydrocarbon gas refills for small devices, with release device
- 3151 **171** Halogenated monomethyldiphenylmethanes, liquid
- 3151 **171** Polyhalogenated biphenyls, liquid
- 3151 **171** Polyhalogenated terphenyls, liquid
- 3152 **171** Halogenated monomethyldiphenylmethanes, solid
- 3152 **171** Polyhalogenated biphenyls, solid
- 3152 **171** Polyhalogenated terphenyls, solid
- 3153 **115** Perfluoro(methyl vinyl ether)
- 3154 **115** Perfluoro(ethyl vinyl ether)
- 3155 **154** Pentachlorophenol
- 3156 **122** Compressed gas, oxidizing, n.o.s.
- 3157 **122** Liquefied gas, oxidizing, n.o.s.
- 3158 **120** Gas, refrigerated liquid, n.o.s.
- 3159 **126** Refrigerant gas R-134a
- 3159 **126** 1,1,1,2-Tetrafluoroethane
- 3160 **119** Liquefied gas, poisonous, flammable, n.o.s.

ID Guide No. No. Name of Material

ID Guide No. No. Name of Material

3160 119 Liquefied gas, poisonous, flammable, n.o.s. (Inhalation Hazard Zone A)

3160 119 Liquefied gas, poisonous, flammable, n.o.s. (Inhalation Hazard Zone B)

3160 119 Liquefied gas, poisonous, flammable, n.o.s. (Inhalation Hazard Zone C)

3160 119 Liquefied gas, poisonous, flammable, n.o.s. (Inhalation Hazard Zone D)

3160 119 Liquefied gas, toxic, flammable, n.o.s.

3160 119 Liquefied gas, toxic, flammable, n.o.s. (Inhalation Hazard Zone A)

3160 119 Liquefied gas, toxic, flammable, n.o.s. (Inhalation Hazard Zone B)

3160 119 Liquefied gas, toxic, flammable, n.o.s. (Inhalation Hazard Zone C)

3160 119 Liquefied gas, toxic, flammable, n.o.s. (Inhalation Hazard Zone D)

3161 115 Liquefied gas, flammable, n.o.s.

3162 123 Liquefied gas, poisonous, n.o.s.

3162 123 Liquefied gas, poisonous, n.o.s. (Inhalation Hazard Zone A)

3162 123 Liquefied gas, poisonous, n.o.s. (Inhalation Hazard Zone B)

3162 123 Liquefied gas, poisonous, n.o.s. (Inhalation Hazard Zone C)

3162 123 Liquefied gas, poisonous, n.o.s. (Inhalation Hazard Zone D)

3162 123 Liquefied gas, toxic, n.o.s.

3162 123 Liquefied gas, toxic, n.o.s. (Inhalation Hazard Zone A)

3162 123 Liquefied gas, toxic, n.o.s. (Inhalation Hazard Zone B)

3162 123 Liquefied gas, toxic, n.o.s. (Inhalation Hazard Zone C)

3162 123 Liquefied gas, toxic, n.o.s. (Inhalation Hazard Zone D)

3163 126 Liquefied gas, n.o.s.

3164 126 Articles, pressurized, hydraulic (containing non-flammable gas)

3164 126 Articles, pressurized, pneumatic (containing non-flammable gas)

3165 131 Aircraft hydraulic power unit fuel tank

3166 115 Engine, fuel cell, flammable gas powered

3166 128 Engine, fuel cell, flammable liquid powered

3166 128 Engine, internal combustion

3166 115 Engines, internal combustion, flammable gas powered

3166 128 Engines, internal combustion, flammable liquid powered

3166 115 Vehicle, flammable gas powered

3166 128 Vehicle, flammable liquid powered

3166 115 Vehicle, fuel cell, flammable gas powered

3166 128 Vehicle, fuel cell, flammable liquid powered

3167 115 Gas sample, non-pressurized, flammable, n.o.s., not refrigerated liquid

3168 119 Gas sample, non-pressurized, poisonous, flammable, n.o.s., not refrigerated liquid

3168 119 Gas sample, non-pressurized, toxic, flammable, n.o.s., not refrigerated liquid

**ID Guide Name of Material
No. No.**

3169	123	Gas sample, non-pressurized, poisonous, n.o.s., not refrigerated liquid
3169	123	Gas sample, non-pressurized, toxic, n.o.s., not refrigerated liquid
3170	138	Aluminum dross
3170	138	Aluminum remelting by-products
3170	138	Aluminum smelting by-products
3171	154	Battery-powered equipment (wet battery)
3171	147	Battery-powered equipment (with lithium ion batteries)
3171	138	Battery-powered equipment (with lithium metal batteries)
3171	138	Battery-powered equipment (with sodium batteries)
3171	154	Battery-powered vehicle (wet battery)
3171	147	Battery-powered vehicle (with lithium ion batteries)
3171	138	Battery-powered vehicle (with sodium batteries)
3171	154	Wheelchair, electric, with batteries
3172	153	Toxins, extracted from living sources, liquid, n.o.s.
3174	135	Titanium disulfide
3174	135	Titanium disulphide
3175	133	Solids containing flammable liquid, n.o.s.
3176	133	Flammable solid, organic, molten, n.o.s.
3178	133	Flammable solid, inorganic, n.o.s.
3178	133	Smokeless powder for small arms
3179	134	Flammable solid, poisonous, inorganic, n.o.s.

**ID Guide Name of Material
No. No.**

3179	134	Flammable solid, toxic, inorganic, n.o.s.
3180	134	Flammable solid, corrosive, inorganic, n.o.s.
3181	133	Metal salts of organic compounds, flammable, n.o.s.
3182	170	Metal hydrides, flammable, n.o.s.
3183	135	Self-heating liquid, organic, n.o.s.
3184	136	Self-heating liquid, poisonous, organic, n.o.s.
3184	136	Self-heating liquid, toxic, organic, n.o.s.
3185	136	Self-heating liquid, corrosive, organic, n.o.s.
3186	135	Self-heating liquid, inorganic, n.o.s.
3187	136	Self-heating liquid, poisonous, inorganic, n.o.s.
3187	136	Self-heating liquid, toxic, inorganic, n.o.s.
3188	136	Self-heating liquid, corrosive, inorganic, n.o.s.
3189	135	Metal powder, self-heating, n.o.s.
3190	135	Self-heating solid, inorganic, n.o.s.
3191	136	Self-heating solid, poisonous, inorganic, n.o.s.
3191	136	Self-heating solid, toxic, inorganic, n.o.s.
3192	136	Self-heating solid, corrosive, inorganic, n.o.s.
3194	135	Pyrophoric liquid, inorganic, n.o.s.
3200	135	Pyrophoric solid, inorganic, n.o.s.

**ID Guide Name of Material
No. No.****ID Guide Name of Material
No. No.**

3205	135	Alkaline earth metal alcoholates, n.o.s.
3206	136	Alkali metal alcoholates, self-heating, corrosive, n.o.s.
3208	138	Metallic substance, water-reactive, n.o.s.
3209	138	Metallic substance, water-reactive, self-heating, n.o.s.
3210	140	Chlorates, inorganic, aqueous solution, n.o.s.
3211	140	Perchlorates, inorganic, aqueous solution, n.o.s.
3212	140	Hypochlorites, inorganic, n.o.s.
3213	140	Bromates, inorganic, aqueous solution, n.o.s.
3214	140	Permanganates, inorganic, aqueous solution, n.o.s.
3215	140	Persulfates, inorganic, n.o.s.
3215	140	Persulphates, inorganic, n.o.s.
3216	140	Persulfates, inorganic, aqueous solution, n.o.s.
3216	140	Persulphates, inorganic, aqueous solution, n.o.s.
3218	140	Nitrates, inorganic, aqueous solution, n.o.s.
3219	140	Nitrites, inorganic, aqueous solution, n.o.s.
3220	126	Pentafluoroethane
3220	126	Refrigerant gas R-125
3221	149	Self-reactive liquid type B
3222	149	Self-reactive solid type B
3223	149	Self-reactive liquid type C
3224	149	Self-reactive solid type C
3225	149	Self-reactive liquid type D
3226	149	Self-reactive solid type D
3227	149	Self-reactive liquid type E

3228	149	Self-reactive solid type E
3229	149	Self-reactive liquid type F
3230	149	Self-reactive solid type F
3231	150	Self-reactive liquid type B, temperature controlled
3232	150	Self-reactive solid type B, temperature controlled
3233	150	Self-reactive liquid type C, temperature controlled
3234	150	Self-reactive solid type C, temperature controlled
3235	150	Self-reactive liquid type D, temperature controlled
3236	150	Self-reactive solid type D, temperature controlled
3237	150	Self-reactive liquid type E, temperature controlled
3238	150	Self-reactive solid type E, temperature controlled
3239	150	Self-reactive liquid type F, temperature controlled
3240	150	Self-reactive solid type F, temperature controlled
3241	133	2-Bromo-2-nitropropane-1, 3-diol
3242	149	Azodicarbonamide
3243	151	Solids containing poisonous liquid, n.o.s.
3243	151	Solids containing toxic liquid, n.o.s.
3244	154	Solids containing corrosive liquid, n.o.s.
3245	171	Genetically modified micro-organisms
3245	171	Genetically modified organisms
3246	156	Methanesulfonyl chloride
3246	156	Methanesulphonyl chloride

ID Guide Name of Material
No. No.

3247	140	Sodium peroxoborate, anhydrous
3248	131	Medicine, liquid, flammable, poisonous, n.o.s.
3248	131	Medicine, liquid, flammable, toxic, n.o.s.
3249	151	Medicine, solid, poisonous, n.o.s.
3249	151	Medicine, solid, toxic, n.o.s.
3250	153	Chloroacetic acid, molten
3251	133	Isosorbide-5-mononitrate
3252	115	Difluoromethane
3252	115	Refrigerant gas R-32
3253	154	Disodium trioxosilicate
3254	135	Tributylphosphane
3255	135	tert-Butyl hypochlorite
3256	128	Elevated temperature liquid, flammable, n.o.s., with flash point above 37.8°C (100°F), at or above its flash point
3256	128	Elevated temperature liquid, flammable, n.o.s., with flash point above 60°C (140°F), at or above its flash point
3257	171	Elevated temperature liquid, n.o.s., at or above 100°C (212°F), and below its flash point
3258	171	Elevated temperature solid, n.o.s., at or above 240°C (464°F)
3259	154	Amines, solid, corrosive, n.o.s.
3259	154	Polyamines, solid, corrosive, n.o.s.
3260	154	Corrosive solid, acidic, inorganic, n.o.s.
3261	154	Corrosive solid, acidic, organic, n.o.s.

ID Guide Name of Material
No. No.

3262	154	Corrosive solid, basic, inorganic, n.o.s.
3263	154	Corrosive solid, basic, organic, n.o.s.
3264	154	Corrosive liquid, acidic, inorganic, n.o.s.
3265	153	Corrosive liquid, acidic, organic, n.o.s.
3266	154	Corrosive liquid, basic, inorganic, n.o.s.
3267	153	Corrosive liquid, basic, organic, n.o.s.
3268	171	Air bag inflators
3268	171	Air bag modules
3268	171	Safety devices
3268	171	Seat-belt pre-tensioners
3269	128	Polyester resin kit, liquid base material
3270	133	Nitrocellulose membrane filters
3271	127	Ethers, n.o.s.
3272	127	Esters, n.o.s.
3273	131	Nitriles, flammable, poisonous, n.o.s.
3273	131	Nitriles, flammable, toxic, n.o.s.
3274	132	Alcoholates solution, n.o.s., in alcohol
3275	131	Nitriles, poisonous, flammable, n.o.s.
3275	131	Nitriles, toxic, flammable, n.o.s.
3276	151	Nitriles, liquid, poisonous, n.o.s.
3276	151	Nitriles, liquid, toxic, n.o.s.
3276	151	Nitriles, poisonous, liquid, n.o.s.
3276	151	Nitriles, toxic, liquid, n.o.s.
3277	154	Chloroformates, poisonous, corrosive, n.o.s.

**ID Guide Name of Material
No. No.**

3277	154	Chloroformates, toxic, corrosive, n.o.s.
3278	151	Organophosphorus compound, liquid, poisonous, n.o.s.
3278	151	Organophosphorus compound, liquid, toxic, n.o.s.
3278	151	Organophosphorus compound, poisonous, liquid, n.o.s.
3278	151	Organophosphorus compound, toxic, liquid, n.o.s.
3279	131	Organophosphorus compound, poisonous, flammable, n.o.s.
3279	131	Organophosphorus compound, toxic, flammable, n.o.s.
3280	151	Organoarsenic compound, liquid, n.o.s.
3281	151	Metal carbonyls, liquid, n.o.s.
3282	151	Organometallic compound, liquid, poisonous, n.o.s.
3282	151	Organometallic compound, liquid, toxic, n.o.s.
3282	151	Organometallic compound, poisonous, liquid, n.o.s.
3282	151	Organometallic compound, toxic, liquid, n.o.s.
3283	151	Selenium compound, solid, n.o.s.
3284	151	Tellurium compound, n.o.s.
3285	151	Vanadium compound, n.o.s.
3286	131	Flammable liquid, poisonous, corrosive, n.o.s.
3286	131	Flammable liquid, toxic, corrosive, n.o.s.
3287	151	Poisonous liquid, inorganic, n.o.s.
3287	151	Toxic liquid, inorganic, n.o.s.
3288	151	Poisonous solid, inorganic, n.o.s.

**ID Guide Name of Material
No. No.**

3288	151	Toxic solid, inorganic, n.o.s.
3289	154	Poisonous liquid, corrosive, inorganic, n.o.s.
3289	154	Toxic liquid, corrosive, inorganic, n.o.s.
3290	154	Poisonous solid, corrosive, inorganic, n.o.s.
3290	154	Toxic solid, corrosive, inorganic, n.o.s.
3291	158	(Bio)Medical waste, n.o.s.
3291	158	Clinical waste, unspecified, n.o.s.
3291	158	Medical waste, n.o.s.
3291	158	Regulated medical waste, n.o.s.
3292	138	Batteries, containing Sodium
3292	138	Cells, containing Sodium
3292	138	Sodium, batteries containing
3293	152	Hydrazine, aqueous solution, with not more than 37% Hydrazine
3294	131	Hydrogen cyanide, solution in alcohol, with not more than 45% Hydrogen cyanide
3295	128	Hydrocarbons, liquid, n.o.s.
3296	126	Heptafluoropropane
3296	126	Refrigerant gas R-227
3297	126	Chlorotetrafluoroethane and Ethylene oxide mixture, with not more than 8.8% Ethylene oxide
3297	126	Ethylene oxide and Chlorotetrafluoroethane mixture, with not more than 8.8% Ethylene oxide
3298	126	Ethylene oxide and Pentafluoroethane mixture, with not more than 7.9% Ethylene oxide

**ID Guide Name of Material
No. No.**

3298	126	Pentafluoroethane and Ethylene oxide mixture, with not more than 7.9% Ethylene oxide
3299	126	Ethylene oxide and Tetrafluoroethane mixture, with not more than 5.6% Ethylene oxide
3299	126	Tetrafluoroethane and Ethylene oxide mixture, with not more than 5.6% Ethylene oxide
3300	119P	Carbon dioxide and Ethylene oxide mixture, with more than 87% Ethylene oxide
3300	119P	Ethylene oxide and Carbon dioxide mixture, with more than 87% Ethylene oxide
3301	136	Corrosive liquid, self-heating, n.o.s.
3302	152	2-Dimethylaminoethyl acrylate
3303	124	Compressed gas, poisonous, oxidizing, n.o.s.
3303	124	Compressed gas, poisonous, oxidizing, n.o.s. (Inhalation Hazard Zone A)
3303	124	Compressed gas, poisonous, oxidizing, n.o.s. (Inhalation Hazard Zone B)
3303	124	Compressed gas, poisonous, oxidizing, n.o.s. (Inhalation Hazard Zone C)
3303	124	Compressed gas, poisonous, oxidizing, n.o.s. (Inhalation Hazard Zone D)
3303	124	Compressed gas, toxic, oxidizing, n.o.s.
3303	124	Compressed gas, toxic, oxidizing, n.o.s. (Inhalation Hazard Zone A)
3303	124	Compressed gas, toxic, oxidizing, n.o.s. (Inhalation Hazard Zone B)

**ID Guide Name of Material
No. No.**

3303	124	Compressed gas, toxic, oxidizing, n.o.s. (Inhalation Hazard Zone C)
3303	124	Compressed gas, toxic, oxidizing, n.o.s. (Inhalation Hazard Zone D)
3304	125	Compressed gas, poisonous, corrosive, n.o.s.
3304	125	Compressed gas, poisonous, corrosive, n.o.s. (Inhalation Hazard Zone A)
3304	125	Compressed gas, poisonous, corrosive, n.o.s. (Inhalation Hazard Zone B)
3304	125	Compressed gas, poisonous, corrosive, n.o.s. (Inhalation Hazard Zone C)
3304	125	Compressed gas, poisonous, corrosive, n.o.s. (Inhalation Hazard Zone D)
3304	125	Compressed gas, toxic, corrosive, n.o.s.
3304	125	Compressed gas, toxic, corrosive, n.o.s. (Inhalation Hazard Zone A)
3304	125	Compressed gas, toxic, corrosive, n.o.s. (Inhalation Hazard Zone B)
3304	125	Compressed gas, toxic, corrosive, n.o.s. (Inhalation Hazard Zone C)
3304	125	Compressed gas, toxic, corrosive, n.o.s. (Inhalation Hazard Zone D)
3305	119	Compressed gas, poisonous, flammable, corrosive, n.o.s.
3305	119	Compressed gas, poisonous, flammable, corrosive, n.o.s. (Inhalation Hazard Zone A)
3305	119	Compressed gas, poisonous, flammable, corrosive, n.o.s. (Inhalation Hazard Zone B)

ID Guide No. No. Name of Material

ID Guide No. No. Name of Material

3305 119 Compressed gas, poisonous, flammable, corrosive, n.o.s. (Inhalation Hazard Zone C)

3306 124 Compressed gas, toxic, oxidizing, corrosive, n.o.s. (Inhalation Hazard Zone C)

3305 119 Compressed gas, poisonous, flammable, corrosive, n.o.s. (Inhalation Hazard Zone D)

3306 124 Compressed gas, toxic, oxidizing, corrosive, n.o.s. (Inhalation Hazard Zone D)

3305 119 Compressed gas, toxic, flammable, corrosive, n.o.s.

3307 124 Liquefied gas, poisonous, oxidizing, n.o.s.

3305 119 Compressed gas, toxic, flammable, corrosive, n.o.s. (Inhalation Hazard Zone A)

3307 124 Liquefied gas, poisonous, oxidizing, n.o.s. (Inhalation Hazard Zone A)

3305 119 Compressed gas, toxic, flammable, corrosive, n.o.s. (Inhalation Hazard Zone B)

3307 124 Liquefied gas, poisonous, oxidizing, n.o.s. (Inhalation Hazard Zone B)

3305 119 Compressed gas, toxic, flammable, corrosive, n.o.s. (Inhalation Hazard Zone C)

3307 124 Liquefied gas, poisonous, oxidizing, n.o.s. (Inhalation Hazard Zone C)

3305 119 Compressed gas, toxic, flammable, corrosive, n.o.s. (Inhalation Hazard Zone D)

3307 124 Liquefied gas, poisonous, oxidizing, n.o.s. (Inhalation Hazard Zone D)

3306 124 Compressed gas, poisonous, oxidizing, corrosive, n.o.s.

3307 124 Liquefied gas, toxic, oxidizing, n.o.s.

3306 124 Compressed gas, poisonous, oxidizing, corrosive, n.o.s. (Inhalation Hazard Zone A)

3307 124 Liquefied gas, toxic, oxidizing, n.o.s. (Inhalation Hazard Zone A)

3306 124 Compressed gas, poisonous, oxidizing, corrosive, n.o.s. (Inhalation Hazard Zone B)

3307 124 Liquefied gas, toxic, oxidizing, n.o.s. (Inhalation Hazard Zone B)

3306 124 Compressed gas, poisonous, oxidizing, corrosive, n.o.s. (Inhalation Hazard Zone C)

3307 124 Liquefied gas, toxic, oxidizing, n.o.s. (Inhalation Hazard Zone C)

3306 124 Compressed gas, poisonous, oxidizing, corrosive, n.o.s. (Inhalation Hazard Zone D)

3307 124 Liquefied gas, toxic, oxidizing, n.o.s. (Inhalation Hazard Zone D)

3306 124 Compressed gas, toxic, oxidizing, corrosive, n.o.s.

3308 125 Liquefied gas, poisonous, corrosive, n.o.s.

3306 124 Compressed gas, toxic, oxidizing, corrosive, n.o.s. (Inhalation Hazard Zone A)

3308 125 Liquefied gas, poisonous, corrosive, n.o.s. (Inhalation Hazard Zone A)

3306 124 Compressed gas, toxic, oxidizing, corrosive, n.o.s. (Inhalation Hazard Zone B)

3308 125 Liquefied gas, poisonous, corrosive, n.o.s. (Inhalation Hazard Zone B)

**ID Guide Name of Material
No. No.**

3308 125	Liquefied gas, poisonous, corrosive, n.o.s. (Inhalation Hazard Zone C)
3308 125	Liquefied gas, poisonous, corrosive, n.o.s. (Inhalation Hazard Zone D)
3308 125	Liquefied gas, toxic, corrosive, n.o.s.
3308 125	Liquefied gas, toxic, corrosive, n.o.s. (Inhalation Hazard Zone A)
3308 125	Liquefied gas, toxic, corrosive, n.o.s. (Inhalation Hazard Zone B)
3308 125	Liquefied gas, toxic, corrosive, n.o.s. (Inhalation Hazard Zone C)
3308 125	Liquefied gas, toxic, corrosive, n.o.s. (Inhalation Hazard Zone D)
3309 119	Liquefied gas, poisonous, flammable, corrosive, n.o.s.
3309 119	Liquefied gas, poisonous, flammable, corrosive, n.o.s. (Inhalation Hazard Zone A)
3309 119	Liquefied gas, poisonous, flammable, corrosive, n.o.s. (Inhalation Hazard Zone B)
3309 119	Liquefied gas, poisonous, flammable, corrosive, n.o.s. (Inhalation Hazard Zone C)
3309 119	Liquefied gas, poisonous, flammable, corrosive, n.o.s. (Inhalation Hazard Zone D)
3309 119	Liquefied gas, toxic, flammable, corrosive, n.o.s.
3309 119	Liquefied gas, toxic, flammable, corrosive, n.o.s. (Inhalation Hazard Zone A)
3309 119	Liquefied gas, toxic, flammable, corrosive, n.o.s. (Inhalation Hazard Zone B)

**ID Guide Name of Material
No. No.**

3309 119	Liquefied gas, toxic, flammable, corrosive, n.o.s. (Inhalation Hazard Zone C)
3309 119	Liquefied gas, toxic, flammable, corrosive, n.o.s. (Inhalation Hazard Zone D)
3310 124	Liquefied gas, poisonous, oxidizing, corrosive, n.o.s.
3310 124	Liquefied gas, poisonous, oxidizing, corrosive, n.o.s. (Inhalation Hazard Zone A)
3310 124	Liquefied gas, poisonous, oxidizing, corrosive, n.o.s. (Inhalation Hazard Zone B)
3310 124	Liquefied gas, poisonous, oxidizing, corrosive, n.o.s. (Inhalation Hazard Zone C)
3310 124	Liquefied gas, poisonous, oxidizing, corrosive, n.o.s. (Inhalation Hazard Zone D)
3310 124	Liquefied gas, toxic, oxidizing, corrosive, n.o.s.
3310 124	Liquefied gas, toxic, oxidizing, corrosive, n.o.s. (Inhalation Hazard Zone A)
3310 124	Liquefied gas, toxic, oxidizing, corrosive, n.o.s. (Inhalation Hazard Zone B)
3310 124	Liquefied gas, toxic, oxidizing, corrosive, n.o.s. (Inhalation Hazard Zone C)
3310 124	Liquefied gas, toxic, oxidizing, corrosive, n.o.s. (Inhalation Hazard Zone D)
3311 122	Gas, refrigerated liquid, oxidizing, n.o.s.
3312 115	Gas, refrigerated liquid, flammable, n.o.s.
3313 135	Organic pigments, self-heating
3314 171	Plastic molding compound
3314 171	Plastics moulding compound

ID Guide Name of Material
No. No.

ID Guide Name of Material
No. No.

3315	151	Chemical sample, poisonous
3315	151	Chemical sample, toxic
3316	171	Chemical kit
3316	171	First aid kit
3317	113	2-Amino-4,6-dinitrophenol, wetted with not less than 20% water
3318	125	Ammonia solution, with more than 50% Ammonia
3319	113	Nitroglycerin mixture, desensitized, solid, n.o.s., with more than 2% but not more than 10% Nitroglycerin
3320	157	Sodium borohydride and Sodium hydroxide solution, with not more than 12% Sodium borohydride and not more than 40% Sodium hydroxide
3321	162	Radioactive material, low specific activity (LSA-II), non fissile or fissile-excepted
3322	162	Radioactive material, low specific activity (LSA-III), non fissile or fissile-excepted
3323	163	Radioactive material, Type C package, non fissile or fissile excepted
3324	165	Radioactive material, low specific activity (LSA-II), fissile
3325	165	Radioactive material, low specific activity (LSA-III), fissile
3326	165	Radioactive material, surface contaminated objects (SCO-I), fissile
3326	165	Radioactive material, surface contaminated objects (SCO-II), fissile
3327	165	Radioactive material, Type A package, fissile, non-special form

3328	165	Radioactive material, Type B(U) package, fissile
3329	165	Radioactive material, Type B(M) package, fissile
3330	165	Radioactive material, Type C package, fissile
3331	165	Radioactive material, transported under special arrangement, fissile
3332	164	Radioactive material, Type A package, special form, non fissile or fissile-excepted
3333	165	Radioactive material, Type A package, special form, fissile
3334	171	Aviation regulated liquid, n.o.s.
3334	171	Self-defense spray, non-pressurized
3335	171	Aviation regulated solid, n.o.s.
3336	130	Mercaptan mixture, liquid, flammable, n.o.s.
3336	130	Mercaptans, liquid, flammable, n.o.s.
3337	126	Refrigerant gas R-404A
3338	126	Refrigerant gas R-407A
3339	126	Refrigerant gas R-407B
3340	126	Refrigerant gas R-407C
3341	135	Thiourea dioxide
3342	135	Xanthates
3343	113	Nitroglycerin mixture, desensitized, liquid, flammable, n.o.s., with not more than 30% Nitroglycerin
3344	113	Pentaerythrite tetranitrate mixture, desensitized, solid, n.o.s., with more than 10% but not more than 20% PETN

ID Guide Name of Material
No. No.

- 3344 113 Pentaerythritol tetranitrate mixture, desensitized, solid, n.o.s., with more than 10% but not more than 20% PETN
- 3344 113 PETN mixture, desensitized, solid, n.o.s., with more than 10% but not more than 20% PETN
- 3345 153 Phenoxyacetic acid derivative pesticide, solid, poisonous
- 3345 153 Phenoxyacetic acid derivative pesticide, solid, toxic
- 3346 131 Phenoxyacetic acid derivative pesticide, liquid, flammable, poisonous
- 3346 131 Phenoxyacetic acid derivative pesticide, liquid, flammable, toxic
- 3347 131 Phenoxyacetic acid derivative pesticide, liquid, poisonous, flammable
- 3347 131 Phenoxyacetic acid derivative pesticide, liquid, toxic, flammable
- 3348 153 Phenoxyacetic acid derivative pesticide, liquid, poisonous
- 3348 153 Phenoxyacetic acid derivative pesticide, liquid, toxic
- 3349 151 Pyrethroid pesticide, solid, poisonous
- 3349 151 Pyrethroid pesticide, solid, toxic
- 3350 131 Pyrethroid pesticide, liquid, flammable, poisonous
- 3350 131 Pyrethroid pesticide, liquid, flammable, toxic
- 3351 131 Pyrethroid pesticide, liquid, poisonous, flammable
- 3351 131 Pyrethroid pesticide, liquid, toxic, flammable
- 3352 151 Pyrethroid pesticide, liquid, poisonous

ID Guide Name of Material
No. No.

- 3352 151 Pyrethroid pesticide, liquid, toxic
- 3354 115 Insecticide gas, flammable, n.o.s.
- 3355 119 Insecticide gas, poisonous, flammable, n.o.s.
- 3355 119 Insecticide gas, poisonous, flammable, n.o.s. (Inhalation Hazard Zone A)
- 3355 119 Insecticide gas, poisonous, flammable, n.o.s. (Inhalation Hazard Zone B)
- 3355 119 Insecticide gas, poisonous, flammable, n.o.s. (Inhalation Hazard Zone C)
- 3355 119 Insecticide gas, poisonous, flammable, n.o.s. (Inhalation Hazard Zone D)
- 3355 119 Insecticide gas, toxic, flammable, n.o.s.
- 3355 119 Insecticide gas, toxic, flammable, n.o.s. (Inhalation Hazard Zone A)
- 3355 119 Insecticide gas, toxic, flammable, n.o.s. (Inhalation Hazard Zone B)
- 3355 119 Insecticide gas, toxic, flammable, n.o.s. (Inhalation Hazard Zone C)
- 3355 119 Insecticide gas, toxic, flammable, n.o.s. (Inhalation Hazard Zone D)
- 3356 140 Oxygen generator, chemical
- 3356 140 Oxygen generator, chemical, spent
- 3357 113 Nitroglycerin mixture, desensitized, liquid, n.o.s., with not more than 30% Nitroglycerin
- 3358 115 Refrigerating machines, containing flammable, non-poisonous, liquefied gas

**ID Guide Name of Material
No. No.**

3358	115	Refrigerating machines, containing flammable, non-toxic, liquefied gas
3359	171	Fumigated cargo transport unit
3360	133	Fibers, vegetable, dry
3360	133	Fibres, vegetable, dry
3361	156	Chlorosilanes, poisonous, corrosive, n.o.s.
3361	156	Chlorosilanes, toxic, corrosive, n.o.s.
3362	155	Chlorosilanes, poisonous, corrosive, flammable, n.o.s.
3362	155	Chlorosilanes, toxic, corrosive, flammable, n.o.s.
3363	171	Dangerous goods in apparatus
3363	171	Dangerous goods in articles
3363	171	Dangerous goods in machinery
3364	113	Picric acid, wetted with not less than 10% water
3364	113	Trinitrophenol, wetted with not less than 10% water
3365	113	Picryl chloride, wetted with not less than 10% water
3365	113	Trinitrochlorobenzene, wetted with not less than 10% water
3366	113	TNT, wetted with not less than 10% water
3366	113	Trinitrotoluene, wetted with not less than 10% water
3367	113	Trinitrobenzene, wetted with not less than 10% water
3368	113	Trinitrobenzoic acid, wetted with not less than 10% water
3369	113	Sodium dinitro-o-cresolate, wetted with not less than 10% water
3370	113	Urea nitrate, wetted with not less than 10% water
3371	129	2-Methylbutanal

**ID Guide Name of Material
No. No.**

3373	158	Biological substance, category B
3374	116	Acetylene, solvent free
3375	140	Ammonium nitrate emulsion
3375	140	Ammonium nitrate gel
3375	140	Ammonium nitrate suspension
3376	113	4-Nitrophenylhydrazine, with not less than 30% water
3377	140	Sodium perborate monohydrate
3378	140	Sodium carbonate peroxyhydrate
3379	113	Desensitized explosive, liquid, n.o.s.
3380	113	Desensitized explosive, solid, n.o.s.
3381	151	Poisonous by inhalation liquid, n.o.s. (Inhalation Hazard Zone A)
3381	151	Toxic by inhalation liquid, n.o.s. (Inhalation Hazard Zone A)
3382	151	Poisonous by inhalation liquid, n.o.s. (Inhalation Hazard Zone B)
3382	151	Toxic by inhalation liquid, n.o.s. (Inhalation Hazard Zone B)
3383	131	Poisonous by inhalation liquid, flammable, n.o.s. (Inhalation Hazard Zone A)
3383	131	Toxic by inhalation liquid, flammable, n.o.s. (Inhalation Hazard Zone A)
3384	131	Poisonous by inhalation liquid, flammable, n.o.s. (Inhalation Hazard Zone B)
3384	131	Toxic by inhalation liquid, flammable, n.o.s. (Inhalation Hazard Zone B)
3385	139	Poisonous by inhalation liquid, water-reactive, n.o.s. (Inhalation Hazard Zone A)

**ID Guide Name of Material
No. No.**

3385	139	Toxic by inhalation liquid, water-reactive, n.o.s. (Inhalation Hazard Zone A)
3386	139	Poisonous by inhalation liquid, water-reactive, n.o.s. (Inhalation Hazard Zone B)
3386	139	Toxic by inhalation liquid, water-reactive, n.o.s. (Inhalation Hazard Zone B)
3387	142	Poisonous by inhalation liquid, oxidizing, n.o.s. (Inhalation Hazard Zone A)
3387	142	Toxic by inhalation liquid, oxidizing, n.o.s. (Inhalation Hazard Zone A)
3388	142	Poisonous by inhalation liquid, oxidizing, n.o.s. (Inhalation Hazard Zone B)
3388	142	Toxic by inhalation liquid, oxidizing, n.o.s. (Inhalation Hazard Zone B)
3389	154	Poisonous by inhalation liquid, corrosive, n.o.s. (Inhalation Hazard Zone A)
3389	154	Toxic by inhalation liquid, corrosive, n.o.s. (Inhalation Hazard Zone A)
3390	154	Poisonous by inhalation liquid, corrosive, n.o.s. (Inhalation Hazard Zone B)
3390	154	Toxic by inhalation liquid, corrosive, n.o.s. (Inhalation Hazard Zone B)
3391	135	Organometallic substance, solid, pyrophoric
3392	135	Organometallic substance, liquid, pyrophoric
3393	135	Organometallic substance, solid, pyrophoric, water-reactive
3394	135	Organometallic substance, liquid, pyrophoric, water-reactive

**ID Guide Name of Material
No. No.**

3395	135	Organometallic substance, solid, water-reactive
3396	138	Organometallic substance, solid, water-reactive, flammable
3397	138	Organometallic substance, solid, water-reactive, self-heating
3398	135	Organometallic substance, liquid, water-reactive
3399	138	Organometallic substance, liquid, water-reactive, flammable
3400	138	Organometallic substance, solid, self-heating
3401	138	Alkali metal amalgam, solid
3402	138	Alkaline earth metal amalgam, solid
3403	138	Potassium, metal alloys, solid
3404	138	Potassium sodium alloys, solid
3404	138	Sodium potassium alloys, solid
3405	141	Barium chlorate, solution
3406	141	Barium perchlorate, solution
3407	140	Chlorate and Magnesium chloride mixture, solution
3407	140	Magnesium chloride and Chlorate mixture, solution
3408	141	Lead perchlorate, solution
3409	152	Chloronitrobenzenes, liquid
3410	153	4-Chloro-o-toluidine hydrochloride, solution
3411	153	beta-Naphthylamine, solution
3411	153	Naphthylamine (beta), solution
3412	153	Formic acid, with not less than 5% but less than 10% acid
3412	153	Formic acid, with not less than 10% but not more than 85% acid

ID Guide Name of Material
No. No.

3413	157	Potassium cyanide, solution
3414	157	Sodium cyanide, solution
3415	154	Sodium fluoride, solution
3416	153	Chloroacetophenone, liquid
3417	152	Xylyl bromide, solid
3418	151	2,4-Toluenediamine, solution
3418	151	2,4-Toluylenediamine, solution
3419	157	Boron trifluoride acetic acid complex, solid
3420	157	Boron trifluoride propionic acid complex, solid
3421	154	Potassium hydrogen difluoride, solution
3422	154	Potassium fluoride, solution
3423	153	Tetramethylammonium hydroxide, solid
3424	141	Ammonium dinitro-o-cresolate, solution
3425	156	Bromoacetic acid, solid
3426	153P	Acrylamide, solution
3427	153	Chlorobenzyl chlorides, solid
3428	156	3-Chloro-4-methylphenyl isocyanate, solid
3429	153	Chlorotoluidines, liquid
3430	153	Xylenols, liquid
3431	152	Nitrobenzotrifluorides, solid
3432	171	Polychlorinated biphenyls, solid
3434	153	Nitrocresols, liquid
3436	151	Hexafluoroacetone hydrate, solid
3437	152	Chlorocresols, solid
3438	153	alpha-Methylbenzyl alcohol, solid
3438	153	Methylbenzyl (alpha) alcohol, solid

ID Guide Name of Material
No. No.

3439	151	Nitriles, poisonous, solid, n.o.s.
3439	151	Nitriles, solid, poisonous, n.o.s.
3439	151	Nitriles, solid, toxic, n.o.s.
3439	151	Nitriles, toxic, solid, n.o.s.
3440	151	Selenium compound, liquid, n.o.s.
3441	153	Chlorodinitrobenzenes, solid
3442	153	Dichloroanilines, solid
3443	152	Dinitrobenzenes, solid
3444	151	Nicotine hydrochloride, solid
3445	151	Nicotine sulfate, solid
3445	151	Nicotine sulphate, solid
3446	152	Nitrotoluenes, solid
3447	152	Nitroxylenes, solid
3448	159	Tear gas substance, solid, n.o.s.
3449	159	Bromobenzyl cyanides, solid
3450	151	Diphenylchloroarsine, solid
3451	153	Toluidines, solid
3452	153	Xylidines, solid
3453	154	Phosphoric acid, solid
3454	152	Dinitrotoluenes, solid
3455	153	Cresols, solid
3456	157	Nitrosylsulfuric acid, solid
3456	157	Nitrosylsulphuric acid, solid
3457	152	Chloronitrotoluenes, solid
3458	152	Nitroanisoles, solid
3459	152	Nitrobromobenzenes, solid
3460	153	N-Ethylbenzyltoluidines, solid
3462	153	Toxins, extracted from living sources, solid, n.o.s.
3463	153	Propionic acid, with not less than 90% acid

**ID Guide Name of Material
No. No.**

3464	151	Organophosphorus compound, poisonous, solid, n.o.s.
3464	151	Organophosphorus compound, solid, poisonous, n.o.s.
3464	151	Organophosphorus compound, solid, toxic, n.o.s.
3464	151	Organophosphorus compound, toxic, solid, n.o.s.
3465	151	Organoarsenic compound, solid, n.o.s.
3466	151	Metal carbonyls, solid, n.o.s.
3467	151	Organometallic compound, poisonous, solid, n.o.s.
3467	151	Organometallic compound, solid, poisonous, n.o.s.
3467	151	Organometallic compound, solid, toxic, n.o.s.
3467	151	Organometallic compound, toxic, solid, n.o.s.
3468	115	Hydrogen in a metal hydride storage system
3468	115	Hydrogen in a metal hydride storage system contained in equipment
3468	115	Hydrogen in a metal hydride storage system packed with equipment
3469	132	Paint, flammable, corrosive
3469	132	Paint related material, flammable, corrosive
3470	132	Paint, corrosive, flammable
3470	132	Paint related material, corrosive, flammable
3471	154	Hydrogendifluorides, solution, n.o.s.
3472	153	Crotonic acid, liquid
3473	128	Fuel cell cartridges, containing flammable liquids

**ID Guide Name of Material
No. No.**

3473	128	Fuel cell cartridges contained in equipment, containing flammable liquids
3473	128	Fuel cell cartridges packed with equipment, containing flammable liquids
3474	113	1-Hydroxybenzotriazole, anhydrous, wetted with not less than 20% water
3474	113	1-Hydroxybenzotriazole, monohydrate
3475	127	Ethanol and gasoline mixture, with more than 10% ethanol
3475	127	Ethanol and motor spirit mixture, with more than 10% ethanol
3475	127	Ethanol and petrol mixture, with more than 10% ethanol
3475	127	Gasoline and ethanol mixture, with more than 10% ethanol
3475	127	Motor spirit and ethanol mixture, with more than 10% ethanol
3475	127	Petrol and ethanol mixture, with more than 10% ethanol
3476	138	Fuel cell cartridges, containing water-reactive substances
3476	138	Fuel cell cartridges contained in equipment, containing water-reactive substances
3476	138	Fuel cell cartridges packed with equipment, containing water-reactive substances
3477	153	Fuel cell cartridges, containing corrosive substances
3477	153	Fuel cell cartridges contained in equipment, containing corrosive substances
3477	153	Fuel cell cartridges packed with equipment, containing corrosive substances

**ID Guide Name of Material
No. No.**

3478	115	Fuel cell cartridges, containing liquefied flammable gas
3478	115	Fuel cell cartridges contained in equipment, containing liquefied flammable gas
3478	115	Fuel cell cartridges packed with equipment, containing liquefied flammable gas
3479	115	Fuel cell cartridges, containing hydrogen in metal hydride
3479	115	Fuel cell cartridges contained in equipment, containing hydrogen in metal hydride
3479	115	Fuel cell cartridges packed with equipment, containing hydrogen in metal hydride
3480	147	Lithium ion batteries (including lithium ion polymer batteries)
3481	147	Lithium ion batteries contained in equipment (including lithium ion polymer batteries)
3481	147	Lithium ion batteries packed with equipment (including lithium ion polymer batteries)
3482	138	Alkali metal dispersion, flammable
3482	138	Alkaline earth metal dispersion, flammable
3483	131	Motor fuel anti-knock mixture, flammable
3484	132	Hydrazine aqueous solution, flammable, with more than 37% hydrazine, by mass
3485	140	Calcium hypochlorite, dry, corrosive, with more than 39% available chlorine (8.8% available oxygen)
3485	140	Calcium hypochlorite mixture, dry, corrosive, with more than 39% available chlorine (8.8% available oxygen)

**ID Guide Name of Material
No. No.**

3486	140	Calcium hypochlorite mixture, dry, corrosive, with more than 10% but not more than 39% available chlorine
3487	140	Calcium hypochlorite, hydrated, corrosive, with not less than 5.5% but not more than 16% water
3487	140	Calcium hypochlorite, hydrated mixture, corrosive, with not less than 5.5% but not more than 16% water
3488	131	Poisonous by inhalation liquid, flammable, corrosive, n.o.s. (Inhalation Hazard Zone A)
3488	131	Toxic by inhalation liquid, flammable, corrosive, n.o.s. (Inhalation Hazard Zone A)
3489	131	Poisonous by inhalation liquid, flammable, corrosive, n.o.s. (Inhalation Hazard Zone B)
3489	131	Toxic by inhalation liquid, flammable, corrosive, n.o.s. (Inhalation Hazard Zone B)
3490	155	Poisonous by inhalation liquid, water-reactive, flammable, n.o.s. (Inhalation Hazard Zone A)
3490	155	Toxic by inhalation liquid, water-reactive, flammable, n.o.s. (Inhalation Hazard Zone A)
3491	155	Poisonous by inhalation liquid, water-reactive, flammable, n.o.s. (Inhalation Hazard Zone B)
3491	155	Toxic by inhalation liquid, water-reactive, flammable, n.o.s. (Inhalation Hazard Zone B)
3492	131	Poisonous by inhalation liquid, corrosive, flammable, n.o.s. (Inhalation Hazard Zone A)
3492	131	Toxic by inhalation liquid, corrosive, flammable, n.o.s. (Inhalation Hazard Zone A)

ID Guide Name of Material
No. No.

3493	131	Poisonous by inhalation liquid, corrosive, flammable, n.o.s. (Inhalation Hazard Zone B)
3493	131	Toxic by inhalation liquid, corrosive, flammable, n.o.s. (Inhalation Hazard Zone B)
3494	131	Petroleum sour crude oil, flammable, poisonous
3494	131	Petroleum sour crude oil, flammable, toxic
3495	154	Iodine
3496	171	Batteries, nickel-metal hydride
3497	133	Krill meal
3498	157	Iodine monochloride, liquid
3499	171	Capacitor, electric double layer
3500	126	Chemical under pressure, n.o.s.
3501	115	Chemical under pressure, flammable, n.o.s.
3502	123	Chemical under pressure, poisonous, n.o.s.
3502	123	Chemical under pressure, toxic, n.o.s.
3503	125	Chemical under pressure, corrosive, n.o.s.
3504	119	Chemical under pressure, flammable, poisonous, n.o.s.
3504	119	Chemical under pressure, flammable, toxic, n.o.s.
3505	118	Chemical under pressure, flammable, corrosive, n.o.s.
3506	172	Mercury contained in manufactured articles
3507	166	Uranium hexafluoride, radioactive material, excepted package, less than 0.1 kg per package, non-fissile or fissile-excepted
3508	171	Capacitor, asymmetric

ID Guide Name of Material
No. No.

3509	171	Packagings discarded, empty, uncleaned
3510	174	Adsorbed gas, flammable, n.o.s.
3511	174	Adsorbed gas, n.o.s.
3512	173	Adsorbed gas, poisonous, n.o.s.
3512	173	Adsorbed gas, poisonous, n.o.s. (Inhalation hazard zone A)
3512	173	Adsorbed gas, poisonous, n.o.s. (Inhalation hazard zone B)
3512	173	Adsorbed gas, poisonous, n.o.s. (Inhalation hazard zone C)
3512	173	Adsorbed gas, poisonous, n.o.s. (Inhalation hazard zone D)
3512	173	Adsorbed gas, toxic, n.o.s.
3512	173	Adsorbed gas, toxic, n.o.s. (Inhalation hazard zone A)
3512	173	Adsorbed gas, toxic, n.o.s. (Inhalation hazard zone B)
3512	173	Adsorbed gas, toxic, n.o.s. (Inhalation hazard zone C)
3512	173	Adsorbed gas, toxic, n.o.s. (Inhalation hazard zone D)
3513	174	Adsorbed gas, oxidizing, n.o.s.
3514	173	Adsorbed gas, poisonous, flammable, n.o.s.
3514	173	Adsorbed gas, poisonous, flammable, n.o.s. (Inhalation hazard zone A)
3514	173	Adsorbed gas, poisonous, flammable, n.o.s. (Inhalation hazard zone B)
3514	173	Adsorbed gas, poisonous, flammable, n.o.s. (Inhalation hazard zone C)
3514	173	Adsorbed gas, poisonous, flammable, n.o.s. (Inhalation hazard zone D)
3514	173	Adsorbed gas, toxic, flammable, n.o.s.

ID Guide No. No. Name of Material

ID Guide No. No. Name of Material

3514 173 Adsorbed gas, toxic, flammable, n.o.s. (Inhalation hazard zone A)

3516 173 Adsorbed gas, poisonous, corrosive, n.o.s. (Inhalation hazard zone A)

3514 173 Adsorbed gas, toxic, flammable, n.o.s. (Inhalation hazard zone B)

3516 173 Adsorbed gas, poisonous, corrosive, n.o.s. (Inhalation hazard zone B)

3514 173 Adsorbed gas, toxic, flammable, n.o.s. (Inhalation hazard zone C)

3516 173 Adsorbed gas, poisonous, corrosive, n.o.s. (Inhalation hazard zone C)

3514 173 Adsorbed gas, toxic, flammable, n.o.s. (Inhalation hazard zone D)

3516 173 Adsorbed gas, poisonous, corrosive, n.o.s. (Inhalation hazard zone D)

3515 173 Adsorbed gas, poisonous, oxidizing, n.o.s.

3516 173 Adsorbed gas, toxic, corrosive, n.o.s.

3515 173 Adsorbed gas, poisonous, oxidizing, n.o.s. (Inhalation hazard zone A)

3516 173 Adsorbed gas, toxic, corrosive, n.o.s. (Inhalation hazard zone A)

3515 173 Adsorbed gas, poisonous, oxidizing, n.o.s. (Inhalation hazard zone B)

3516 173 Adsorbed gas, toxic, corrosive, n.o.s. (Inhalation hazard zone B)

3515 173 Adsorbed gas, poisonous, oxidizing, n.o.s. (Inhalation hazard zone C)

3516 173 Adsorbed gas, toxic, corrosive, n.o.s. (Inhalation hazard zone C)

3515 173 Adsorbed gas, poisonous, oxidizing, n.o.s. (Inhalation hazard zone D)

3516 173 Adsorbed gas, toxic, corrosive, n.o.s. (Inhalation hazard zone D)

3515 173 Adsorbed gas, toxic, oxidizing, n.o.s.

3517 173 Adsorbed gas, poisonous, flammable, corrosive, n.o.s.

3515 173 Adsorbed gas, toxic, oxidizing, n.o.s. (Inhalation hazard zone A)

3517 173 Adsorbed gas, poisonous, flammable, corrosive, n.o.s. (Inhalation hazard zone A)

3515 173 Adsorbed gas, toxic, oxidizing, n.o.s. (Inhalation hazard zone B)

3517 173 Adsorbed gas, poisonous, flammable, corrosive, n.o.s. (Inhalation hazard zone B)

3515 173 Adsorbed gas, toxic, oxidizing, n.o.s. (Inhalation hazard zone C)

3517 173 Adsorbed gas, poisonous, flammable, corrosive, n.o.s. (Inhalation hazard zone C)

3515 173 Adsorbed gas, toxic, oxidizing, n.o.s. (Inhalation hazard zone D)

3517 173 Adsorbed gas, poisonous, flammable, corrosive, n.o.s. (Inhalation hazard zone D)

3516 173 Adsorbed gas, poisonous, corrosive, n.o.s.

3517 173 Adsorbed gas, toxic, flammable, corrosive, n.o.s.

**ID Guide Name of Material
No. No.**

3517	173	Adsorbed gas, toxic, flammable, corrosive, n.o.s. (Inhalation hazard zone A)
3517	173	Adsorbed gas, toxic, flammable, corrosive, n.o.s. (Inhalation hazard zone B)
3517	173	Adsorbed gas, toxic, flammable, corrosive, n.o.s. (Inhalation hazard zone C)
3517	173	Adsorbed gas, toxic, flammable, corrosive, n.o.s. (Inhalation hazard zone D)
3518	173	Adsorbed gas, poisonous, oxidizing, corrosive, n.o.s.
3518	173	Adsorbed gas, poisonous, oxidizing, corrosive, n.o.s. (Inhalation hazard zone A)
3518	173	Adsorbed gas, poisonous, oxidizing, corrosive, n.o.s. (Inhalation hazard zone B)
3518	173	Adsorbed gas, poisonous, oxidizing, corrosive, n.o.s. (Inhalation hazard zone C)
3518	173	Adsorbed gas, poisonous, oxidizing, corrosive, n.o.s. (Inhalation hazard zone D)
3518	173	Adsorbed gas, toxic, oxidizing, corrosive, n.o.s.
3518	173	Adsorbed gas, toxic, oxidizing, corrosive, n.o.s. (Inhalation hazard zone A)
3518	173	Adsorbed gas, toxic, oxidizing, corrosive, n.o.s. (Inhalation hazard zone B)
3518	173	Adsorbed gas, toxic, oxidizing, corrosive, n.o.s. (Inhalation hazard zone C)
3518	173	Adsorbed gas, toxic, oxidizing, corrosive, n.o.s. (Inhalation hazard zone D)
3519	173	Boron trifluoride, adsorbed
3520	173	Chlorine, adsorbed

**ID Guide Name of Material
No. No.**

3521	173	Silicon tetrafluoride, adsorbed
3522	173	Arsine, adsorbed
3523	173	Germane, adsorbed
3524	173	Phosphorus pentafluoride, adsorbed
3525	173	Phosphine, adsorbed
3526	173	Hydrogen selenide, adsorbed
3527	128P	Polyester resin kit, solid base material
3528	128	Engine, fuel cell, flammable liquid powered
3528	128	Engine, internal combustion, flammable liquid powered
3528	128	Machinery, fuel cell, flammable liquid powered
3528	128	Machinery, internal combustion, flammable liquid powered
3529	115	Engine, fuel cell, flammable gas powered
3529	115	Engine, internal combustion, flammable gas powered
3529	115	Machinery, fuel cell, flammable gas powered
3529	115	Machinery, internal combustion, flammable gas powered
3530	171	Engine, internal combustion
3530	171	Machinery, internal combustion
3531	149P	Polymerizing substance, solid, stabilized, n.o.s.
3532	149P	Polymerizing substance, liquid, stabilized, n.o.s.
3533	150P	Polymerizing substance, solid, temperature controlled, n.o.s.
3534	150P	Polymerizing substance, liquid, temperature controlled, n.o.s.
3535	134	Toxic solid, flammable, inorganic, n.o.s.

**ID Guide Name of Material
No. No.**

**ID Guide Name of Material
No. No.**

3536	147	Lithium batteries installed in cargo transport unit (lithium ion batteries)
3536	138	Lithium batteries installed in cargo transport unit (lithium metal batteries)
3537	115	Articles containing flammable gas, n.o.s.
3538	120	Articles containing non-flammable, non-toxic gas, n.o.s.
3539	123	Articles containing toxic gas, n.o.s.
3540	127	Articles containing flammable liquid, n.o.s.
3541	133	Articles containing flammable solid, n.o.s.
3542	135	Articles containing a substance liable to spontaneous combustion, n.o.s.
3543	138	Articles containing a substance which emits flammable gas in contact with water, n.o.s.
3544	140	Articles containing oxidizing substance, n.o.s.
3545	145	Articles containing organic peroxide, n.o.s.
3546	151	Articles containing toxic substance, n.o.s.
3547	154	Articles containing corrosive substance, n.o.s.
3548	171	Articles containing miscellaneous dangerous goods, n.o.s.
3549	158	Medical waste, category A, affecting humans, solid
3549	158	Medical waste, category A, affecting animals only, solid
8000	171	Consumer commodity
9035	123	Gas identification set

9191	143	Chlorine dioxide, hydrate, frozen
9202	168	Carbon monoxide, refrigerated liquid (cryogenic liquid)
9206	137	Methyl phosphonic dichloride
9260	169	Aluminum, molten
9263	156	Chloropivaloyl chloride
9264	151	3,5-Dichloro-2,4,6-trifluoropyridine
9269	132	Trimethoxysilane

NOTES

INTRODUCTION TO BLUE PAGES

For entries **highlighted in green** follow these steps:

- **IF THERE IS NO FIRE:**

- Go directly to **Table 1** (**green-bordered pages**)
- Look up the ID number and name of material
- Identify initial isolation and protective action distances
- Also consult the appropriate Orange Guide

- **IF A FIRE IS INVOLVED:**

- Use the appropriate Orange Guide for **EVACUATION** distances
- Also protect in downwind direction according to Table 1 for residual material release

Note 1: If the name in **Table 1** is shown with **(when spilled in water)**, these materials produce large amounts of Toxic Inhalation Hazard (TIH) (PIH in the US) gases when spilled in water. Some Water Reactive materials are also TIH materials themselves (e.g., UN1746 (Bromine trifluoride), UN1836 (Thionyl chloride)). In these instances, two entries are provided in **Table 1** for land-based and water-based spills. If a water-reactive material only has one entry in Table 1 for **(when spilled in water)** and the product is NOT spilled in water, Table 1 and Table 2 do not apply. You will find safe distances in the appropriate orange-bordered guide.

Note 2: Explosives are not individually listed by their name because in an emergency situation, the response will be based only on the division of the explosive, not on the individual explosive.

For divisions 1.1, 1.2, 1.3 and 1.5, refer to GUIDE 112.

For divisions 1.4 and 1.6, refer to GUIDE 114.

Note 3: Chemical warfare agents do not have an assigned ID number because they are not commercially transported. In an emergency situation, the assigned orange guide will provide guidance for the initial response. Also consult "Criminal or Terrorist Use of Chemical, Biological and Radiological Agents", pp. 368 to 372.

Name of Material **Guide ID**
No. **No.**

AC	117	—
Acetal	127	1088
Acetaldehyde	129P	1089
Acetaldehyde ammonia	171	1841
Acetaldehyde oxime	129	2332
Acetic acid, glacial	132	2789
Acetic acid, solution, more than 10% but not more than 80% acid	153	2790
Acetic acid, solution, more than 80% acid	132	2789
Acetic anhydride	137	1715
Acetone	127	1090
Acetone cyanohydrin, stabilized	155	1541
Acetone oils	127	1091
Acetonitrile	127	1648
Acetyl bromide	156	1716
Acetyl chloride	155	1717
Acetylene, dissolved	116	1001
Acetylene, Ethylene and Propylene in mixture, refrigerated liquid containing at least 71.5% Ethylene with not more than 22.5% Acetylene and not more than 6% Propylene	115	3138
Acetylene, solvent free	116	3374
Acetylene tetrabromide	159	2504
Acetyl iodide	156	1898
Acetyl methyl carbinol	127	2621
Acid, sludge	153	1906
Acid butyl phosphate	153	1718
Acridine	153	2713
Acrolein, stabilized	131P	1092
Acrolein dimer, stabilized	129P	2607

Name of Material **Guide ID**
No. **No.**

Acrylamide, solid	153P	2074
Acrylamide, solution	153P	3426
Acrylic acid, stabilized	132P	2218
Acrylonitrile, stabilized	131P	1093
Adamsite	154	—
Adhesives (flammable)	128	1133
Adiponitrile	153	2205
Adsorbed gas, flammable, n.o.s.	174	3510
Adsorbed gas, n.o.s.	174	3511
Adsorbed gas, oxidizing, n.o.s.	174	3513
Adsorbed gas, poisonous, corrosive, n.o.s.	173	3516
Adsorbed gas, poisonous, corrosive, n.o.s. (Inhalation hazard zone A)	173	3516
Adsorbed gas, poisonous, corrosive, n.o.s. (Inhalation hazard zone B)	173	3516
Adsorbed gas, poisonous, corrosive, n.o.s. (Inhalation hazard zone C)	173	3516
Adsorbed gas, poisonous, corrosive, n.o.s. (Inhalation hazard zone D)	173	3516
Adsorbed gas, poisonous, flammable, corrosive, n.o.s.	173	3517
Adsorbed gas, poisonous, flammable, corrosive, n.o.s. (Inhalation hazard zone A)	173	3517
Adsorbed gas, poisonous, flammable, corrosive, n.o.s. (Inhalation hazard zone B)	173	3517
Adsorbed gas, poisonous, flammable, corrosive, n.o.s. (Inhalation hazard zone C)	173	3517
Adsorbed gas, poisonous, flammable, corrosive, n.o.s. (Inhalation hazard zone D)	173	3517

Name of Material	Guide No.	ID No.	Name of Material	Guide No.	ID No.
Adsorbed gas, poisonous, flammable, n.o.s.	173	3514	Adsorbed gas, poisonous, oxidizing, n.o.s.	173	3515
Adsorbed gas, poisonous, flammable, n.o.s. (Inhalation hazard zone A)	173	3514	Adsorbed gas, poisonous, oxidizing, n.o.s. (Inhalation hazard zone A)	173	3515
Adsorbed gas, poisonous, flammable, n.o.s. (Inhalation hazard zone B)	173	3514	Adsorbed gas, poisonous, oxidizing, n.o.s. (Inhalation hazard zone B)	173	3515
Adsorbed gas, poisonous, flammable, n.o.s. (Inhalation hazard zone C)	173	3514	Adsorbed gas, poisonous, oxidizing, n.o.s. (Inhalation hazard zone C)	173	3515
Adsorbed gas, poisonous, flammable, n.o.s. (Inhalation hazard zone D)	173	3514	Adsorbed gas, poisonous, oxidizing, n.o.s. (Inhalation hazard zone D)	173	3515
Adsorbed gas, poisonous, n.o.s.	173	3512	Adsorbed gas, toxic, corrosive, n.o.s.	173	3516
Adsorbed gas, poisonous, n.o.s. (Inhalation hazard zone A)	173	3512	Adsorbed gas, toxic, corrosive, n.o.s. (Inhalation hazard zone A)	173	3516
Adsorbed gas, poisonous, n.o.s. (Inhalation hazard zone B)	173	3512	Adsorbed gas, toxic, corrosive, n.o.s. (Inhalation hazard zone B)	173	3516
Adsorbed gas, poisonous, n.o.s. (Inhalation hazard zone C)	173	3512	Adsorbed gas, toxic, corrosive, n.o.s. (Inhalation hazard zone C)	173	3516
Adsorbed gas, poisonous, n.o.s. (Inhalation hazard zone D)	173	3512	Adsorbed gas, toxic, corrosive, n.o.s. (Inhalation hazard zone D)	173	3516
Adsorbed gas, poisonous, oxidizing, corrosive, n.o.s.	173	3518	Adsorbed gas, toxic, flammable, corrosive, n.o.s.	173	3517
Adsorbed gas, poisonous, oxidizing, corrosive, n.o.s. (Inhalation hazard zone A)	173	3518	Adsorbed gas, toxic, flammable, corrosive, n.o.s. (Inhalation hazard zone A)	173	3517
Adsorbed gas, poisonous, oxidizing, corrosive, n.o.s. (Inhalation hazard zone B)	173	3518	Adsorbed gas, toxic, flammable, corrosive, n.o.s. (Inhalation hazard zone B)	173	3517
Adsorbed gas, poisonous, oxidizing, corrosive, n.o.s. (Inhalation hazard zone C)	173	3518	Adsorbed gas, toxic, flammable, corrosive, n.o.s. (Inhalation hazard zone C)	173	3517
Adsorbed gas, poisonous, oxidizing, corrosive, n.o.s. (Inhalation hazard zone D)	173	3518	Adsorbed gas, toxic, flammable, corrosive, n.o.s. (Inhalation hazard zone D)	173	3517

Name of Material	Guide No.	ID No.
------------------	-----------	--------

Name of Material	Guide No.	ID No.
------------------	-----------	--------

Adsorbed gas, toxic, flammable, n.o.s.	173	3514
Adsorbed gas, toxic, flammable, n.o.s. (Inhalation hazard zone A)	173	3514
Adsorbed gas, toxic, flammable, n.o.s. (Inhalation hazard zone B)	173	3514
Adsorbed gas, toxic, flammable, n.o.s. (Inhalation hazard zone C)	173	3514
Adsorbed gas, toxic, flammable, n.o.s. (Inhalation hazard zone D)	173	3514
Adsorbed gas, toxic, n.o.s.	173	3512
Adsorbed gas, toxic, n.o.s. (Inhalation hazard zone A)	173	3512
Adsorbed gas, toxic, n.o.s. (Inhalation hazard zone B)	173	3512
Adsorbed gas, toxic, n.o.s. (Inhalation hazard zone C)	173	3512
Adsorbed gas, toxic, n.o.s. (Inhalation hazard zone D)	173	3512
Adsorbed gas, toxic, oxidizing, corrosive, n.o.s.	173	3518
Adsorbed gas, toxic, oxidizing, corrosive, n.o.s. (Inhalation hazard zone A)	173	3518
Adsorbed gas, toxic, oxidizing, corrosive, n.o.s. (Inhalation hazard zone B)	173	3518
Adsorbed gas, toxic, oxidizing, corrosive, n.o.s. (Inhalation hazard zone C)	173	3518
Adsorbed gas, toxic, oxidizing, corrosive, n.o.s. (Inhalation hazard zone D)	173	3518
Adsorbed gas, toxic, oxidizing, n.o.s.	173	3515
Adsorbed gas, toxic, oxidizing, n.o.s. (Inhalation hazard zone A)	173	3515

Adsorbed gas, toxic, oxidizing, n.o.s. (Inhalation hazard zone B)	173	3515
Adsorbed gas, toxic, oxidizing, n.o.s. (Inhalation hazard zone C)	173	3515
Adsorbed gas, toxic, oxidizing, n.o.s. (Inhalation hazard zone D)	173	3515
Aerosols	126	1950
Air, compressed	122	1002
Air, refrigerated liquid (cryogenic liquid)	122	1003
Air bag inflators	171	3268
Air bag modules	171	3268
Aircraft hydraulic power unit fuel tank	131	3165
Alcoholates solution, n.o.s., in alcohol	132	3274
Alcoholic beverages	127	3065
Alcohols, flammable, poisonous, n.o.s.	131	1986
Alcohols, flammable, toxic, n.o.s.	131	1986
Alcohols, n.o.s.	127	1987
Aldehydes, flammable, poisonous, n.o.s.	131P	1988
Aldehydes, flammable, toxic, n.o.s.	131P	1988
Aldehydes, n.o.s.	129P	1989
Aldol	153	2839
Alkali metal alcoholates, self-heating, corrosive, n.o.s.	136	3206
Alkali metal alloy, liquid, n.o.s.	138	1421
Alkali metal amalgam, liquid	138	1389
Alkali metal amalgam, solid	138	3401
Alkali metal amides	139	1390

Name of Material	Guide No.	ID No.	Name of Material	Guide No.	ID No.
Alkali metal dispersion	138	1391	Alkyl sulphonic acids, liquid, with more than 5% free Sulphuric acid	153	2584
Alkali metal dispersion, flammable	138	3482	Alkyl sulphonic acids, liquid, with not more than 5% free Sulphuric acid	153	2586
Alkaline earth metal alcoholates, n.o.s.	135	3205	Alkyl sulphonic acids, solid, with more than 5% free Sulphuric acid	153	2583
Alkaline earth metal alloy, n.o.s.	138	1393	Alkyl sulphonic acids, solid, with not more than 5% free Sulphuric acid	153	2585
Alkaline earth metal amalgam, liquid	138	1392	Alkylsulphuric acids	156	2571
Alkaline earth metal amalgam, solid	138	3402	Allyl acetate	131	2333
Alkaline earth metal dispersion	138	1391	Allyl alcohol	131	1098
Alkaline earth metal dispersion, flammable	138	3482	Allylamine	131	2334
Alkaloids, liquid, n.o.s. (poisonous)	151	3140	Allyl bromide	131P	1099
Alkaloids, solid, n.o.s. (poisonous)	151	1544	Allyl chloride	131P	1100
Alkaloid salts, liquid, n.o.s. (poisonous)	151	3140	Allyl chlorocarbonate	155	1722
Alkaloid salts, solid, n.o.s. (poisonous)	151	1544	Allyl chloroformate	155	1722
Alkylphenols, liquid, n.o.s. (including C2-C12 homologues)	153	3145	Allyl ethyl ether	131	2335
Alkylphenols, solid, n.o.s. (including C2-C12 homologues)	153	2430	Allyl formate	131	2336
Alkyl sulfonic acids, liquid, with more than 5% free Sulfuric acid	153	2584	Allyl glycidyl ether	129	2219
Alkyl sulfonic acids, liquid, with not more than 5% free Sulfuric acid	153	2586	Allyl iodide	132	1723
Alkyl sulfonic acids, solid, with more than 5% free Sulfuric acid	153	2583	Allyl isothiocyanate, stabilized	155	1545
Alkyl sulfonic acids, solid, with not more than 5% free Sulfuric acid	153	2585	Allyltrichlorosilane, stabilized	155	1724
Alkylsulfuric acids	156	2571	alpha-Methylbenzyl alcohol, liquid	153	2937
			alpha-Methylbenzyl alcohol, solid	153	3438
			alpha-Methylvaleraldehyde	130	2367
			alpha-Naphthylamine	153	2077
			alpha-Pinene	128	2368
			Aluminum, molten	169	9260
			Aluminum alkyl hydrides	138	3076
			Aluminum alkyls	135	3051

Name of Material	Guide No.	ID No.	Name of Material	Guide No.	ID No.
Aluminum borohydride	135	2870	2-(2-Aminoethoxy)ethanol	154	3055
Aluminum borohydride in devices	135	2870	N-Aminoethylpiperazine	153	2815
Aluminum bromide, anhydrous	137	1725	Aminophenols	152	2512
Aluminum bromide, solution	154	2580	Aminopyridines	153	2671
Aluminum carbide	138	1394	Ammonia, anhydrous	125	1005
Aluminum chloride, anhydrous	137	1726	Ammonia, solution, with more than 10% but not more than 35% Ammonia	154	2672
Aluminum chloride, solution	154	2581	Ammonia, solution, with more than 35% but not more than 50% Ammonia	125	2073
Aluminum dross	138	3170	Ammonia solution, with more than 50% Ammonia	125	3318
Aluminum ferrosilicon powder	139	1395	Ammonium arsenate	151	1546
Aluminum hydride	138	2463	Ammonium bifluoride, solid	154	1727
Aluminum nitrate	140	1438	Ammonium bifluoride, solution	154	2817
Aluminum phosphide	139	1397	Ammonium dichromate	141	1439
Aluminum phosphide pesticide	157	3048	Ammonium dinitro-o-cresolate, solid	141	1843
Aluminum powder, coated	170	1309	Ammonium dinitro-o-cresolate, solution	141	3424
Aluminum powder, pyrophoric	135	1383	Ammonium fluoride	154	2505
Aluminum powder, uncoated	138	1396	Ammonium fluorosilicate	151	2854
Aluminum remelting by-products	138	3170	Ammonium hydrogendifluoride, solid	154	1727
Aluminum resinate	133	2715	Ammonium hydrogendifluoride, solution	154	2817
Aluminum silicon powder, uncoated	138	1398	Ammonium hydrogen sulfate	154	2506
Aluminum smelting by-products	138	3170	Ammonium hydrogen sulphate	154	2506
Amines, flammable, corrosive, n.o.s.	132	2733	Ammonium hydroxide	154	2672
Amines, liquid, corrosive, flammable, n.o.s.	132	2734	Ammonium hydroxide, with more than 10% but not more than 35% Ammonia	154	2672
Amines, liquid, corrosive, n.o.s.	153	2735	Ammonium metavanadate	154	2859
Amines, solid, corrosive, n.o.s.	154	3259	Ammonium nitrate, liquid (hot concentrated solution)	140	2426
2-Amino-4-chlorophenol	151	2673			
2-Amino-5-diethylaminopentane	153	2946			
2-Amino-4,6-dinitrophenol, wetted with not less than 20% water	113	3317			

Name of Material	Guide No.	ID No.	Name of Material	Guide No.	ID No.
Ammonium nitrate, with not more than 0.2% combustible substances	140	1942	n-Amylene	128	1108
Ammonium nitrate based fertilizer	140	2067	Amyl formates	129	1109
Ammonium nitrate based fertilizer	140	2071	Amyl mercaptan	130	1111
Ammonium nitrate emulsion	140	3375	n-Amyl methyl ketone	127	1110
Ammonium nitrate-fuel oil mixtures	112	---	Amyl nitrate	128	1112
Ammonium nitrate gel	140	3375	Amyl nitrite	129	1113
Ammonium nitrate suspension	140	3375	Amyltrichlorosilane	155	1728
Ammonium perchlorate	143	1442	Anhydrous ammonia	125	1005
Ammonium persulfate	140	1444	Aniline	153	1547
Ammonium persulphate	140	1444	Aniline hydrochloride	153	1548
Ammonium picrate, wetted with not less than 10% water	113	1310	Anisidines	153	2431
Ammonium polysulfide, solution	154	2818	Anisole	128	2222
Ammonium polysulphide, solution	154	2818	Anisoyl chloride	156	1729
Ammonium polyvanadate	151	2861	Antimony compound, inorganic, liquid, n.o.s.	157	3141
Ammonium silicofluoride	151	2854	Antimony compound, inorganic, solid, n.o.s.	157	1549
Ammonium sulfide, solution	132	2683	Antimony lactate	151	1550
Ammonium sulphide, solution	132	2683	Antimony pentachloride, liquid	157	1730
Ammunition, poisonous, non-explosive	151	2016	Antimony pentachloride, solution	157	1731
Ammunition, tear-producing, non-explosive	159	2017	Antimony pentafluoride	157	1732
Ammunition, toxic, non-explosive	151	2016	Antimony potassium tartrate	151	1551
Amyl acetates	129	1104	Antimony powder	170	2871
Amyl acid phosphate	153	2819	Antimony trichloride	157	1733
Amylamine	132	1106	Antimony trichloride, liquid	157	1733
Amyl butyrates	130	2620	Antimony trichloride, solid	157	1733
Amyl chloride	129	1107	Aqua regia	157	1798
			Argon	120	1006
			Argon, compressed	120	1006
			Argon, refrigerated liquid (cryogenic liquid)	120	1951
			Arsenic	152	1558

Name of Material	Guide No.	ID No.	Name of Material	Guide No.	ID No.
Arsenic acid, liquid	154	1553	Articles containing flammable gas, n.o.s.	115	3537
Arsenic acid, solid	154	1554	Articles containing flammable liquid, n.o.s.	127	3540
Arsenical dust	152	1562	Articles containing flammable solid, n.o.s.	133	3541
Arsenical pesticide, liquid, flammable, poisonous	131	2760	Articles containing miscellaneous dangerous goods, n.o.s.	171	3548
Arsenical pesticide, liquid, flammable, toxic	131	2760	Articles containing non-flammable, non-toxic gas, n.o.s.	120	3538
Arsenical pesticide, liquid, poisonous	151	2994	Articles containing oxidizing substance, n.o.s.	140	3544
Arsenical pesticide, liquid, poisonous, flammable	131	2993	Articles containing organic peroxide, n.o.s.	145	3545
Arsenical pesticide, liquid, toxic	151	2994	Articles containing Polychlorinated biphenyls (PCB)	171	2315
Arsenical pesticide, liquid, toxic, flammable	131	2993	Articles containing toxic gas, n.o.s.	123	3539
Arsenical pesticide, solid, poisonous	151	2759	Articles containing toxic substance, n.o.s.	151	3546
Arsenical pesticide, solid, toxic	151	2759	Articles, pressurized, hydraulic (containing non-flammable gas)	126	3164
Arsenic bromide	151	1555	Articles, pressurized, pneumatic (containing non-flammable gas)	126	3164
Arsenic chloride	157	1560	Aryl sulfonic acids, liquid, with more than 5% free Sulfuric acid	153	2584
Arsenic compound, liquid, n.o.s.	152	1556	Aryl sulfonic acids, liquid, with not more than 5% free Sulfuric acid	153	2586
Arsenic compound, solid, n.o.s.	152	1557	Aryl sulfonic acids, solid, with more than 5% free Sulfuric acid	153	2583
Arsenic pentoxide	151	1559	Aryl sulfonic acids, solid, with not more than 5% free Sulfuric acid	153	2585
Arsenic trichloride	157	1560			
Arsenic trioxide	151	1561			
Arsine	119	2188			
Arsine, adsorbed	173	3522			
Articles containing a substance liable to spontaneous combustion, n.o.s.	135	3542			
Articles containing a substance which emits flammable gas in contact with water, n.o.s.	138	3543			
Articles containing corrosive substance, n.o.s.	154	3547			

Name of Material	Guide No.	ID No.	Name of Material	Guide No.	ID No.
Aryl sulphonic acids, liquid, with more than 5% free Sulphuric acid	153	2584	Barium perchlorate, solid	141	1447
Aryl sulphonic acids, liquid, with not more than 5% free Sulphuric acid	153	2586	Barium perchlorate, solution	141	3406
Aryl sulphonic acids, solid, with more than 5% free Sulphuric acid	153	2583	Barium permanganate	141	1448
Aryl sulphonic acids, solid, with not more than 5% free Sulphuric acid	153	2585	Barium peroxide	141	1449
Asbestos	171	2212	Batteries, containing Sodium	138	3292
Asbestos, amphibole	171	2212	Batteries, dry, containing Potassium hydroxide solid	154	3028
Asbestos, blue	171	2212	Batteries, nickel-metal hydride	171	3496
Asbestos, brown	171	2212	Batteries, wet, filled with acid	154	2794
Asbestos, chrysotile	171	2590	Batteries, wet, filled with alkali	154	2795
Asbestos, white	171	2590	Batteries, wet, non-spillable	154	2800
Asphalt	130	1999	Battery fluid, acid	157	2796
Asphalt, cut back	130	1999	Battery fluid, alkali	154	2797
Aviation regulated liquid, n.o.s.	171	3334	Battery-powered equipment (wet battery)	154	3171
Aviation regulated solid, n.o.s.	171	3335	Battery-powered equipment (with lithium ion batteries)	147	3171
Azodicarbonamide	149	3242	Battery-powered equipment (with lithium metal batteries)	138	3171
Barium	138	1400	Battery-powered equipment (with sodium batteries)	138	3171
Barium alloys, pyrophoric	135	1854	Battery-powered vehicle (wet battery)	154	3171
Barium azide, wetted with not less than 50% water	113	1571	Battery-powered vehicle (with lithium ion batteries)	147	3171
Barium bromate	141	2719	Battery-powered vehicle (with sodium batteries)	138	3171
Barium chlorate, solid	141	1445	Benzaldehyde	171	1990
Barium chlorate, solution	141	3405	Benzene	130	1114
Barium compound, n.o.s.	154	1564	Benzene phosphorus dichloride	137	2798
Barium cyanide	157	1565	Benzene phosphorus thiodichloride	137	2799
Barium hypochlorite, with more than 22% available Chlorine	141	2741	Benzenesulfonyl chloride	156	2225
Barium nitrate	141	1446	Benzenesulphonyl chloride	156	2225
Barium oxide	157	1884	Benzidine	153	1885
			Benzonitrile	152	2224

Name of Material	Guide No.	ID No.	Name of Material	Guide No.	ID No.
Benzoquinone	153	2587	Bipyridilium pesticide, solid, poisonous	151	2781
Benzotrichloride	156	2226	Bipyridilium pesticide, solid, toxic	151	2781
Benzotrifluoride	127	2338	Bisulfates, aqueous solution	154	2837
Benzoyl chloride	137	1736	Bisulfites, aqueous solution, n.o.s.	154	2693
Benzyl bromide	156	1737	Bisulphates, aqueous solution	154	2837
Benzyl chloride	156	1738	Bisulphites, aqueous solution, n.o.s.	154	2693
Benzyl chloroformate	137	1739	Blasting agent, n.o.s.	112	—
Benzyl dimethylamine	132	2619	Bleaching powder	140	2208
Benzylidene chloride	156	1886	Blue asbestos	171	2212
Benzyl iodide	156	2653	Bombs, smoke, non-explosive, with corrosive liquid, without initiating device	153	2028
Beryllium compound, n.o.s.	154	1566	Borate and Chlorate mixture	140	1458
Beryllium nitrate	141	2464	Borneol	133	1312
Beryllium powder	134	1567	Boron tribromide	157	2692
beta-Naphthylamine, solid	153	1650	Boron trichloride	125	1741
beta-Naphthylamine, solution	153	3411	Boron trifluoride	125	1008
Bhusa, wet, damp or contaminated with oil	133	1327	Boron trifluoride, adsorbed	173	3519
Bicyclo[2.2.1]hepta-2,5-diene, stabilized	128P	2251	Boron trifluoride, compressed	125	1008
Biological agents	158	—	Boron trifluoride, dihydrate	157	2851
Biological substance, category B	158	3373	Boron trifluoride acetic acid complex, liquid	157	1742
(Bio)Medical waste, n.o.s.	158	3291	Boron trifluoride acetic acid complex, solid	157	3419
Bipyridilium pesticide, liquid, flammable, poisonous	131	2782	Boron trifluoride diethyl etherate	132	2604
Bipyridilium pesticide, liquid, flammable, toxic	131	2782	Boron trifluoride dimethyl etherate	139	2965
Bipyridilium pesticide, liquid, poisonous	151	3016	Boron trifluoride propionic acid complex, liquid	157	1743
Bipyridilium pesticide, liquid, poisonous, flammable	131	3015	Boron trifluoride propionic acid complex, solid	157	3420
Bipyridilium pesticide, liquid, toxic	151	3016			
Bipyridilium pesticide, liquid, toxic, flammable	131	3015			

Name of Material	Guide No.	ID No.	Name of Material	Guide No.	ID No.
Bromates, inorganic, aqueous solution, n.o.s.	140	3213	Bromotrifluoromethane	126	1009
Bromates, inorganic, n.o.s.	140	1450	Brown asbestos	171	2212
Bromine	154	1744	Brucine	152	1570
Bromine, solution	154	1744	Butadienes, stabilized	116P	1010
Bromine, solution (Inhalation Hazard Zone A)	154	1744	Butadienes and hydrocarbon mixture, stabilized	116P	1010
Bromine, solution (Inhalation Hazard Zone B)	154	1744	Butane	115	1011
Bromine chloride	124	2901	Butane	115	1075
Bromine pentafluoride	144	1745	Butanedione	127	2346
Bromine trifluoride	144	1746	Butanols	129	1120
Bromoacetic acid, solid	156	3425	Butyl acetates	129	1123
Bromoacetic acid, solution	156	1938	Butyl acid phosphate	153	1718
Bromoacetone	131	1569	Butyl acrylates, stabilized	129P	2348
Bromoacetyl bromide	156	2513	n-Butylamine	132	1125
Bromobenzene	130	2514	N-Butylaniline	153	2738
Bromobenzyl cyanides, liquid	159	1694	Butylbenzenes	128	2709
Bromobenzyl cyanides, solid	159	3449	n-Butyl bromide	130	1126
1-Bromobutane	130	1126	n-Butyl chloride	130	1127
2-Bromobutane	130	2339	n-Butyl chloroformate	155	2743
Bromochloromethane	160	1887	sec-Butyl chloroformate	155	2742
1-Bromo-3-chloropropane	159	2688	tert-Butylcyclohexyl chloroformate	156	2747
2-Bromoethyl ethyl ether	130	2340	Butylene	115	1012
Bromoform	159	2515	Butylene	115	1075
1-Bromo-3-methylbutane	130	2341	1,2-Butylene oxide, stabilized	127P	3022
Bromomethylpropanes	130	2342	Butyl ethers	128	1149
2-Bromo-2-nitropropane-1,3-diol	133	3241	n-Butyl formate	129	1128
2-Bromopentane	130	2343	tert-Butyl hypochlorite	135	3255
Bromopropanes	129	2344	N,n-Butylimidazole	152	2690
3-Bromopropyne	130	2345	n-Butyl isocyanate	155P	2485
Bromotrifluoroethylene	116	2419	tert-Butyl isocyanate	155	2484
			Butyl mercaptan	130	2347

Name of Material	Guide No.	ID No.	Name of Material	Guide No.	ID No.
n-Butyl methacrylate, stabilized	130P	2227	Calcium arsenite and Calcium arsenate mixture, solid	151	1574
Butyl methyl ether	127	2350	Calcium carbide	138	1402
Butyl nitrites	129	2351	Calcium chlorate	140	1452
Butyl propionates	130	1914	Calcium chlorate, aqueous solution	140	2429
Butyltoluenes	152	2667	Calcium chlorite	140	1453
Butyltrichlorosilane	155	1747	Calcium cyanamide, with more than 0.1% Calcium carbide	138	1403
5-tert-Butyl-2,4,6-trinitro-m-xylene	149	2956	Calcium cyanide	157	1575
Butyl vinyl ether, stabilized	127P	2352	Calcium dithionite	135	1923
1,4-Butynediol	153	2716	Calcium hydride	138	1404
Butyraldehyde	129P	1129	Calcium hydrosulfite	135	1923
Butyraldoxime	129	2840	Calcium hydrosulphite	135	1923
Butyric acid	153	2820	Calcium hypochlorite, dry	140	1748
Butyric anhydride	156	2739	Calcium hypochlorite, dry, corrosive, with more than 39% available chlorine (8.8% available oxygen)	140	3485
Butyronitrile	131	2411	Calcium hypochlorite, hydrated, corrosive, with not less than 5.5% but not more than 16% water	140	3487
Butyryl chloride	132	2353	Calcium hypochlorite, hydrated, with not less than 5.5% but not more than 16% water	140	2880
Buzz	153	—	Calcium hypochlorite, hydrated mixture, corrosive, with not less than 5.5% but not more than 16% water	140	3487
BZ	153	—	Calcium hypochlorite, hydrated mixture, with not less than 5.5% but not more than 16% water	140	2880
CA	159	—	Calcium hypochlorite mixture, dry, corrosive, with more than 10% but not more than 39% available chlorine	140	3486
Cacodylic acid	151	1572			
Cadmium compound	154	2570			
Caesium	138	1407			
Caesium hydroxide	157	2682			
Caesium hydroxide, solution	154	2681			
Caesium nitrate	140	1451			
Calcium	138	1401			
Calcium, pyrophoric	135	1855			
Calcium alloys, pyrophoric	135	1855			
Calcium arsenate	151	1573			
Calcium arsenate and Calcium arsenite mixture, solid	151	1574			

Name of Material	Guide No.	ID No.	Name of Material	Guide No.	ID No.
Calcium hypochlorite mixture, dry, corrosive, with more than 39% available chlorine (8.8% available oxygen)	140	3485	Carbamate pesticide, liquid, toxic, flammable	131	2991
Calcium hypochlorite mixture, dry, with more than 10% but not more than 39% available Chlorine	140	2208	Carbamate pesticide, solid, poisonous	151	2757
Calcium hypochlorite mixture, dry, with more than 39% available Chlorine (8.8% available Oxygen)	140	1748	Carbamate pesticide, solid, toxic	151	2757
Calcium manganese silicon	138	2844	Carbon, activated	133	1362
Calcium nitrate	140	1454	Carbon, animal or vegetable origin	133	1361
Calcium oxide	157	1910	Carbon bisulfide	131	1131
Calcium perchlorate	140	1455	Carbon bisulphide	131	1131
Calcium permanganate	140	1456	Carbon dioxide	120	1013
Calcium peroxide	140	1457	Carbon dioxide, compressed	120	1013
Calcium phosphide	139	1360	Carbon dioxide, refrigerated liquid	120	2187
Calcium resinate	133	1313	Carbon dioxide, solid	120	1845
Calcium resinate, fused	133	1314	Carbon dioxide and Ethylene oxide mixture, with more than 9% but not more than 87% Ethylene oxide	115	1041
Calcium silicide	138	1405	Carbon dioxide and Ethylene oxide mixture, with more than 87% Ethylene oxide	119P	3300
Camphor, synthetic	133	2717	Carbon dioxide and Ethylene oxide mixtures, with not more than 9% Ethylene oxide	126	1952
Camphor oil	128	1130	Carbon dioxide and Nitrous oxide mixture	126	1015
Capacitor, asymmetric	171	3508	Carbon dioxide and Oxygen mixture, compressed	122	1014
Capacitor, electric double layer	171	3499	Carbon disulfide	131	1131
Caproic acid	153	2829	Carbon disulphide	131	1131
Carbamate pesticide, liquid, flammable, poisonous	131	2758	Carbon monoxide	119	1016
Carbamate pesticide, liquid, flammable, toxic	131	2758	Carbon monoxide, compressed	119	1016
Carbamate pesticide, liquid, poisonous	151	2992	Carbon monoxide, refrigerated liquid (cryogenic liquid)	168	9202
Carbamate pesticide, liquid, poisonous, flammable	131	2991	Carbon tetrabromide	151	2516
Carbamate pesticide, liquid, toxic	151	2992	Carbon tetrachloride	151	1846

Name of Material **Guide ID**
No. **No.**

Name of Material **Guide ID**
No. **No.**

Carbonyl fluoride	125	2417
Carbonyl fluoride, compressed	125	2417
Carbonyl sulfide	119	2204
Carbonyl sulphide	119	2204
Castor beans, meal, pomace or flake	171	2969
Caustic alkali liquid, n.o.s.	154	1719
Caustic potash, solid	154	1813
Caustic potash, solution	154	1814
Caustic soda, solid	154	1823
Caustic soda, solution	154	1824
Cells, containing Sodium	138	3292
Celluloid, in blocks, rods, rolls, sheets, tubes, etc., except scrap	133	2000
Celluloid, scrap	135	2002
Cerium, slabs, ingots or rods	170	1333
Cerium, turnings or gritty powder	138	3078
Cesium	138	1407
Cesium hydroxide	157	2682
Cesium hydroxide, solution	154	2681
Cesium nitrate	140	1451
CG	125	—
Charcoal	133	1361
Chemical kit	154	1760
Chemical kit	171	3316
Chemical sample, poisonous	151	3315
Chemical sample, toxic	151	3315
Chemical under pressure, corrosive, n.o.s.	125	3503
Chemical under pressure, flammable, corrosive, n.o.s.	118	3505
Chemical under pressure, flammable, n.o.s.	115	3501

Chemical under pressure, flammable, poisonous, n.o.s.	119	3504
Chemical under pressure, flammable, toxic, n.o.s.	119	3504
Chemical under pressure, n.o.s.	126	3500
Chemical under pressure, poisonous, n.o.s.	123	3502
Chemical under pressure, toxic, n.o.s.	123	3502
Chloral, anhydrous, stabilized	153	2075
Chlorate and Borate mixture	140	1458
Chlorate and Magnesium chloride mixture, solid	140	1459
Chlorate and Magnesium chloride mixture, solution	140	3407
Chlorates, inorganic, aqueous solution, n.o.s.	140	3210
Chlorates, inorganic, n.o.s.	140	1461
Chloric acid, aqueous solution, with not more than 10% Chloric acid	140	2626
Chlorine	124	1017
Chlorine, adsorbed	173	3520
Chlorine dioxide, hydrate, frozen	143	9191
Chlorine pentafluoride	124	2548
Chlorine trifluoride	124	1749
Chlorite solution	154	1908
Chlorites, inorganic, n.o.s.	143	1462
Chloroacetaldehyde	153	2232
Chloroacetic acid, molten	153	3250
Chloroacetic acid, solid	153	1751
Chloroacetic acid, solution	153	1750
Chloroacetone, stabilized	131	1695
Chloroacetonitrile	131	2668

Name of Material	Guide No.	ID No.	Name of Material	Guide No.	ID No.
Chloroacetophenone, liquid	153	3416	3-Chloro-4-methylphenyl isocyanate, solid	156	3428
Chloroacetophenone, solid	153	1697	Chloronitroanilines	153	2237
Chloroacetyl chloride	156	1752	Chloronitrobenzenes, liquid	152	3409
Chloroanilines, liquid	152	2019	Chloronitrobenzenes, solid	152	1578
Chloroanilines, solid	152	2018	Chloronitrotoluenes, liquid	152	2433
Chloroanisidines	152	2233	Chloronitrotoluenes, solid	152	3457
Chlorobenzene	130	1134	Chloropentafluoroethane	126	1020
Chlorobenzotrifluorides	130	2234	Chloropentafluoroethane and Chlorodifluoromethane mixture	126	1973
Chlorobenzyl chlorides, liquid	153	2235	Chlorophenolates, liquid	154	2904
Chlorobenzyl chlorides, solid	153	3427	Chlorophenolates, solid	154	2905
Chlorobutanes	130	1127	Chlorophenols, liquid	153	2021
Chlorocresols, solid	152	3437	Chlorophenols, solid	153	2020
Chlorocresols, solution	152	2669	Chlorophenyltrichlorosilane	156	1753
Chlorodifluorobromomethane	126	1974	Chloropicrin	154	1580
1-Chloro-1,1-difluoroethane	115	2517	Chloropicrin and Methyl bromide mixture	123	1581
Chlorodifluoromethane	126	1018	Chloropicrin and Methyl chloride mixture	119	1582
Chlorodifluoromethane and Chloropentafluoroethane mixture	126	1973	Chloropicrin mixture, n.o.s.	154	1583
Chlorodinitrobenzenes, liquid	153	1577	Chloropivaloyl chloride	156	9263
Chlorodinitrobenzenes, solid	153	3441	Chloroplatinic acid, solid	154	2507
2-Chloroethanal	153	2232	Chloroprene, stabilized	131P	1991
Chloroform	151	1888	1-Chloropropane	129	1278
Chloroformates, poisonous, corrosive, flammable, n.o.s.	155	2742	2-Chloropropane	129	2356
Chloroformates, poisonous, corrosive, n.o.s.	154	3277	3-Chloropropanol-1	153	2849
Chloroformates, toxic, corrosive, flammable, n.o.s.	155	2742	2-Chloropropene	130P	2456
Chloroformates, toxic, corrosive, n.o.s.	154	3277	2-Chloropropionic acid	153	2511
Chloromethyl chloroformate	157	2745	2-Chloropyridine	153	2822
Chloromethyl ethyl ether	131	2354	Chlorosilanes, corrosive, flammable, n.o.s.	155	2986
3-Chloro-4-methylphenyl isocyanate, liquid	156	2236	Chlorosilanes, corrosive, n.o.s.	156	2987

Name of Material **Guide ID**
No. **No.**

Name of Material **Guide ID**
No. **No.**

Chlorosilanes, flammable, corrosive, n.o.s.	155	2985
Chlorosilanes, poisonous, corrosive, flammable, n.o.s.	155	3362
Chlorosilanes, poisonous, corrosive, n.o.s.	156	3361
Chlorosilanes, toxic, corrosive, flammable, n.o.s.	155	3362
Chlorosilanes, toxic, corrosive, n.o.s.	156	3361
Chlorosilanes, water-reactive, flammable, corrosive, n.o.s.	139	2988
Chlorosulfonic acid (with or without sulfur trioxide)	137	1754
Chlorosulphonic acid (with or without sulphur trioxide)	137	1754
1-Chloro-1,2,2,2-tetrafluoroethane	126	1021
Chlorotetrafluoroethane and Ethylene oxide mixture, with not more than 8.8% Ethylene oxide	126	3297
Chlorotoluenes	129	2238
4-Chloro-o-toluidine hydrochloride, solid	153	1579
4-Chloro-o-toluidine hydrochloride, solution	153	3410
Chlorotoluidines, liquid	153	3429
Chlorotoluidines, solid	153	2239
1-Chloro-2,2,2-trifluoroethane	126	1983
Chlorotrifluoromethane	126	1022
Chlorotrifluoromethane and Trifluoromethane azeotropic mixture with approximately 60% Chlorotrifluoromethane	126	2599
Chromic acid, solution	154	1755
Chromic fluoride, solid	154	1756
Chromic fluoride, solution	154	1757
Chromium nitrate	141	2720

Chromium oxychloride	137	1758
Chromium trioxide, anhydrous	141	1463
Chromosulfuric acid	154	2240
Chromosulphuric acid	154	2240
CK	125	—
Clinical waste, unspecified, n.o.s.	158	3291
CN	153	—
Coal gas	119	1023
Coal gas, compressed	119	1023
Coal tar distillates, flammable	128	1136
Coating solution	127	1139
Cobalt naphthenates, powder	133	2001
Cobalt resinate, precipitated	133	1318
Combustible liquid, n.o.s.	128	1993
Compounds, cleaning liquid (corrosive)	154	1760
Compounds, cleaning liquid (flammable)	128	1993
Compounds, tree or weed killing, liquid (corrosive)	154	1760
Compounds, tree or weed killing, liquid (flammable)	128	1993
Compounds, tree or weed killing, liquid (toxic)	153	2810
Compressed gas, flammable, n.o.s.	115	1954
Compressed gas, n.o.s.	126	1956
Compressed gas, oxidizing, n.o.s.	122	3156
Compressed gas, poisonous, corrosive, n.o.s.	125	3304
Compressed gas, poisonous, corrosive, n.o.s. (Inhalation Hazard Zone A)	125	3304

Name of Material	Guide No.	ID No.	Name of Material	Guide No.	ID No.
Compressed gas, poisonous, corrosive, n.o.s. (Inhalation Hazard Zone B)	125	3304	Compressed gas, poisonous, n.o.s. (Inhalation Hazard Zone B)	123	1955
Compressed gas, poisonous, corrosive, n.o.s. (Inhalation Hazard Zone C)	125	3304	Compressed gas, poisonous, n.o.s. (Inhalation Hazard Zone C)	123	1955
Compressed gas, poisonous, corrosive, n.o.s. (Inhalation Hazard Zone D)	125	3304	Compressed gas, poisonous, n.o.s. (Inhalation Hazard Zone D)	123	1955
Compressed gas, poisonous, flammable, corrosive, n.o.s.	119	3305	Compressed gas, poisonous, oxidizing, corrosive, n.o.s.	124	3306
Compressed gas, poisonous, flammable, corrosive, n.o.s. (Inhalation Hazard Zone A)	119	3305	Compressed gas, poisonous, oxidizing, corrosive, n.o.s. (Inhalation Hazard Zone A)	124	3306
Compressed gas, poisonous, flammable, corrosive, n.o.s. (Inhalation Hazard Zone B)	119	3305	Compressed gas, poisonous, oxidizing, corrosive, n.o.s. (Inhalation Hazard Zone B)	124	3306
Compressed gas, poisonous, flammable, corrosive, n.o.s. (Inhalation Hazard Zone C)	119	3305	Compressed gas, poisonous, oxidizing, corrosive, n.o.s. (Inhalation Hazard Zone C)	124	3306
Compressed gas, poisonous, flammable, corrosive, n.o.s. (Inhalation Hazard Zone D)	119	3305	Compressed gas, poisonous, oxidizing, corrosive, n.o.s. (Inhalation Hazard Zone D)	124	3306
Compressed gas, poisonous, flammable, n.o.s.	119	1953	Compressed gas, poisonous, oxidizing, n.o.s.	124	3303
Compressed gas, poisonous, flammable, n.o.s. (Inhalation Hazard Zone A)	119	1953	Compressed gas, poisonous, oxidizing, n.o.s. (Inhalation Hazard Zone A)	124	3303
Compressed gas, poisonous, flammable, n.o.s. (Inhalation Hazard Zone B)	119	1953	Compressed gas, poisonous, oxidizing, n.o.s. (Inhalation Hazard Zone B)	124	3303
Compressed gas, poisonous, flammable, n.o.s. (Inhalation Hazard Zone C)	119	1953	Compressed gas, poisonous, oxidizing, n.o.s. (Inhalation Hazard Zone C)	124	3303
Compressed gas, poisonous, flammable, n.o.s. (Inhalation Hazard Zone D)	119	1953	Compressed gas, poisonous, oxidizing, n.o.s. (Inhalation Hazard Zone D)	124	3303
Compressed gas, poisonous, n.o.s.	123	1955	Compressed gas, toxic, corrosive, n.o.s.	125	3304
Compressed gas, poisonous, n.o.s. (Inhalation Hazard Zone A)	123	1955	Compressed gas, toxic, corrosive, n.o.s. (Inhalation Hazard Zone A)	125	3304

Name of Material	Guide No.	ID No.
------------------	-----------	--------

Compressed gas, toxic, corrosive, n.o.s. (Inhalation Hazard Zone B)	125	3304
Compressed gas, toxic, corrosive, n.o.s. (Inhalation Hazard Zone C)	125	3304
Compressed gas, toxic, corrosive, n.o.s. (Inhalation Hazard Zone D)	125	3304
Compressed gas, toxic, flammable, corrosive, n.o.s.	119	3305
Compressed gas, toxic, flammable, corrosive, n.o.s. (Inhalation Hazard Zone A)	119	3305
Compressed gas, toxic, flammable, corrosive, n.o.s. (Inhalation Hazard Zone B)	119	3305
Compressed gas, toxic, flammable, corrosive, n.o.s. (Inhalation Hazard Zone C)	119	3305
Compressed gas, toxic, flammable, corrosive, n.o.s. (Inhalation Hazard Zone D)	119	3305
Compressed gas, toxic, flammable, n.o.s.	119	1953
Compressed gas, toxic, flammable, n.o.s. (Inhalation Hazard Zone A)	119	1953
Compressed gas, toxic, flammable, n.o.s. (Inhalation Hazard Zone B)	119	1953
Compressed gas, toxic, flammable, n.o.s. (Inhalation Hazard Zone C)	119	1953
Compressed gas, toxic, flammable, n.o.s. (Inhalation Hazard Zone D)	119	1953
Compressed gas, toxic, n.o.s.	123	1955
Compressed gas, toxic, n.o.s. (Inhalation Hazard Zone A)	123	1955
Compressed gas, toxic, n.o.s. (Inhalation Hazard Zone B)	123	1955

Name of Material	Guide No.	ID No.
------------------	-----------	--------

Compressed gas, toxic, n.o.s. (Inhalation Hazard Zone C)	123	1955
Compressed gas, toxic, n.o.s. (Inhalation Hazard Zone D)	123	1955
Compressed gas, toxic, oxidizing, corrosive, n.o.s.	124	3306
Compressed gas, toxic, oxidizing, corrosive, n.o.s. (Inhalation Hazard Zone A)	124	3306
Compressed gas, toxic, oxidizing, corrosive, n.o.s. (Inhalation Hazard Zone B)	124	3306
Compressed gas, toxic, oxidizing, corrosive, n.o.s. (Inhalation Hazard Zone C)	124	3306
Compressed gas, toxic, oxidizing, corrosive, n.o.s. (Inhalation Hazard Zone D)	124	3306
Compressed gas, toxic, oxidizing, n.o.s.	124	3303
Compressed gas, toxic, oxidizing, n.o.s. (Inhalation Hazard Zone A)	124	3303
Compressed gas, toxic, oxidizing, n.o.s. (Inhalation Hazard Zone B)	124	3303
Compressed gas, toxic, oxidizing, n.o.s. (Inhalation Hazard Zone C)	124	3303
Compressed gas, toxic, oxidizing, n.o.s. (Inhalation Hazard Zone D)	124	3303
Compressed gas and hexaethyl tetraphosphate mixture	123	1612
Consumer commodity	171	8000
Copper acetoarsenite	151	1585
Copper arsenite	151	1586
Copper based pesticide, liquid, flammable, poisonous	131	2776
Copper based pesticide, liquid, flammable, toxic	131	2776

Name of Material	Guide No.	ID No.	Name of Material	Guide No.	ID No.
Copper based pesticide, liquid, poisonous	151	3010	Corrosive solid, acidic, organic, n.o.s.	154	3261
Copper based pesticide, liquid, poisonous, flammable	131	3009	Corrosive solid, basic, inorganic, n.o.s.	154	3262
Copper based pesticide, liquid, toxic	151	3010	Corrosive solid, basic, organic, n.o.s.	154	3263
Copper based pesticide, liquid, toxic, flammable	131	3009	Corrosive solid, flammable, n.o.s.	134	2921
Copper based pesticide, solid, poisonous	151	2775	Corrosive solid, n.o.s.	154	1759
Copper based pesticide, solid, toxic	151	2775	Corrosive solid, oxidizing, n.o.s.	157	3084
Copper chlorate	140	2721	Corrosive solid, poisonous, n.o.s.	154	2923
Copper chloride	154	2802	Corrosive solid, self-heating, n.o.s.	136	3095
Copper cyanide	151	1587	Corrosive solid, toxic, n.o.s.	154	2923
Copra	135	1363	Corrosive solid, water-reactive, n.o.s.	138	3096
Corrosive liquid, acidic, inorganic, n.o.s.	154	3264	Cotton	133	1365
Corrosive liquid, acidic, organic, n.o.s.	153	3265	Cotton, wet	133	1365
Corrosive liquid, basic, inorganic, n.o.s.	154	3266	Cotton waste, oily	133	1364
Corrosive liquid, basic, organic, n.o.s.	153	3267	Coumarin derivative pesticide, liquid, flammable, poisonous	131	3024
Corrosive liquid, flammable, n.o.s.	132	2920	Coumarin derivative pesticide, liquid, flammable, toxic	131	3024
Corrosive liquid, n.o.s.	154	1760	Coumarin derivative pesticide, liquid, poisonous	151	3026
Corrosive liquid, oxidizing, n.o.s.	157	3093	Coumarin derivative pesticide, liquid, poisonous, flammable	131	3025
Corrosive liquid, poisonous, n.o.s.	154	2922	Coumarin derivative pesticide, liquid, toxic	151	3026
Corrosive liquid, self-heating, n.o.s.	136	3301	Coumarin derivative pesticide, liquid, toxic, flammable	131	3025
Corrosive liquid, toxic, n.o.s.	154	2922	Coumarin derivative pesticide, solid, poisonous	151	3027
Corrosive liquid, water-reactive, n.o.s.	138	3094	Coumarin derivative pesticide, solid, toxic	151	3027
Corrosive solid, acidic, inorganic, n.o.s.	154	3260	Cresols, liquid	153	2076

Name of Material	Guide No.	ID No.	Name of Material	Guide No.	ID No.
Cresols, solid	153	3455	Cyclohexyl mercaptan	129	3054
Cresylic acid	153	2022	Cyclohexyltrichlorosilane	156	1763
Crotonaldehyde	131P	1143	Cyclooctadiene phosphines	135	2940
Crotonaldehyde, stabilized	131P	1143	Cyclooctadienes	130P	2520
Crotonic acid, liquid	153	3472	Cyclooctatetraene	128P	2358
Crotonic acid, solid	153	2823	Cyclopentane	128	1146
Crotonylene	128	1144	Cyclopentanol	129	2244
CS	153	—	Cyclopentanone	128	2245
Cumene	130	1918	Cyclopentene	128	2246
Cupriethylenediamine, solution	154	1761	Cyclopropane	115	1027
CX	154	—	Cymenes	130	2046
Cyanide solution, n.o.s.	157	1935	DA	151	—
Cyanides, inorganic, solid, n.o.s.	157	1588	Dangerous goods in apparatus	171	3363
Cyanogen	119	1026	Dangerous goods in articles	171	3363
Cyanogen bromide	157	1889	Dangerous goods in machinery	171	3363
Cyanogen chloride, stabilized	125	1589	DC	153	—
Cyanuric chloride	157	2670	Decaborane	134	1868
Cyclobutane	115	2601	Decahydronaphthalene	130	1147
Cyclobutyl chloroformate	155	2744	n-Decane	128	2247
1,5,9-Cyclododecatriene	153	2518	Denatured alcohol	127	1987
Cycloheptane	128	2241	Desensitized explosive, liquid, n.o.s.	113	3379
Cycloheptatriene	131	2603	Desensitized explosive, solid, n.o.s.	113	3380
Cycloheptene	128	2242	Deuterium	115	1957
Cyclohexane	128	1145	Deuterium, compressed	115	1957
Cyclohexanethiol	129	3054	Devices, small, hydrocarbon gas powered, with release device	115	3150
Cyclohexanone	127	1915	Diacetone alcohol	129	1148
Cyclohexene	130	2256	Diacetyl	127	2346
Cyclohexenyltrichlorosilane	156	1762	Diallylamine	132	2359
Cyclohexyl acetate	130	2243	Diallyl ether	131P	2360
Cyclohexylamine	132	2357	4,4'-Diaminodiphenylmethane	153	2651
Cyclohexyl isocyanate	155	2488			

Name of Material	Guide No.	ID No.	Name of Material	Guide No.	ID No.
Di-n-amylamine	131	2841	Dichloroisocyanuric acid, dry	140	2465
Dibenzylchlorosilane	156	2434	Dichloroisocyanuric acid salts	140	2465
Diborane	119	1911	Dichloroisopropyl ether	153	2490
Diborane, compressed	119	1911	Dichloromethane	160	1593
Diborane mixtures	119	1911	1,1-Dichloro-1-nitroethane	153	2650
1,2-Dibromobutan-3-one	154	2648	Dichloropentanes	130	1152
Dibromochloropropanes	159	2872	Dichlorophenyl isocyanates	156	2250
Dibromodifluoromethane	171	1941	Dichlorophenyltrichlorosilane	156	1766
Dibromomethane	160	2664	1,2-Dichloropropane	130	1279
Di-n-butylamine	132	2248	1,3-Dichloropropanol-2	153	2750
Dibutylaminoethanol	153	2873	Dichloropropenes	129	2047
Dibutyl ethers	128	1149	Dichlorosilane	119	2189
Dichloroacetic acid	153	1764	1,2-Dichloro-1,1,2,2-tetrafluoroethane	126	1958
1,3-Dichloroacetone	153	2649	3,5-Dichloro-2,4,6-trifluoropyridine	151	9264
Dichloroanilines, liquid	153	1590	Dicyclohexylamine	153	2565
Dichloroanilines, solid	153	3442	Dicyclohexylammonium nitrite	133	2687
o-Dichlorobenzene	152	1591	Dicyclopentadiene	130P	2048
2,2'-Dichlorodiethyl ether	152	1916	1,2-Di-(dimethylamino)ethane	129	2372
Dichlorodifluoromethane	126	1028	Didymium nitrate	140	1465
Dichlorodifluoromethane and Difluoroethane azeotropic mixture with approximately 74% Dichlorodifluoromethane	126	2602	Diesel fuel	128	1202
Dichlorodifluoromethane and Ethylene oxide mixture, with not more than 12.5% Ethylene oxide	126	3070	Diesel fuel	128	1993
Dichlorodimethyl ether, symmetrical	131	2249	Diethoxymethane	127	2373
1,1-Dichloroethane	130	2362	3,3-Diethoxypropene	127	2374
1,2-Dichloroethylene	130P	1150	Diethylamine	132	1154
Dichloroethyl ether	152	1916	2-Diethylaminoethanol	132	2686
Dichlorofluoromethane	126	1029	3-Diethylaminopropylamine	132	2684
			N,N-Diethylaniline	153	2432
			Diethylbenzene	130	2049
			Diethyl carbonate	128	2366
			Diethylchlorosilane	155	1767
			Diethylenetriamine	154	2079

Name of Material	Guide No.	ID No.	Name of Material	Guide No.	ID No.
Diethyl ether	127	1155	2-Dimethylaminoacetonitrile	131	2378
N,N-Diethylethylenediamine	132	2685	2-Dimethylaminoethanol	132	2051
Diethyl ketone	127	1156	2-Dimethylaminoethyl acrylate	152	3302
Diethyl sulfate	152	1594	2-Dimethylaminoethyl methacrylate	153P	2522
Diethyl sulfide	129	2375	N,N-Dimethylaniline	153	2253
Diethyl sulphate	152	1594	2,3-Dimethylbutane	128	2457
Diethyl sulphide	129	2375	1,3-Dimethylbutylamine	132	2379
Diethylthiophosphoryl chloride	155	2751	Dimethylcarbamoyl chloride	156	2262
Diethylzinc	135	1366	Dimethyl carbonate	129	1161
Difluorochloroethanes	115	2517	Dimethylcyclohexanes	128	2263
1,1-Difluoroethane	115	1030	N,N-Dimethylcyclohexylamine	132	2264
Difluoroethane and Dichlorodifluoromethane azeotropic mixture with approximately 74% Dichlorodifluoromethane	126	2602	Dimethylcyclohexylamine	132	2264
1,1-Difluoroethylene	116P	1959	Dimethyldichlorosilane	155	1162
Difluoromethane	115	3252	Dimethyldiethoxysilane	127	2380
Difluorophosphoric acid, anhydrous	154	1768	Dimethyldioxanes	127	2707
2,3-Dihydropyran	127	2376	Dimethyl disulfide	131	2381
Diisobutylamine	132	2361	Dimethyl disulphide	131	2381
Diisobutylene, isomeric compounds	128	2050	Dimethyl ether	115	1033
Diisobutyl ketone	128	1157	N,N-Dimethylformamide	129	2265
Diisooctyl acid phosphate	153	1902	Dimethylhydrazine, symmetrical	131	2382
Diisopropylamine	132	1158	Dimethylhydrazine, unsymmetrical	131	1163
Diisopropyl ether	127	1159	2,2-Dimethylpropane	115	2044
Diketene, stabilized	131P	2521	Dimethyl-N-propylamine	132	2266
1,1-Dimethoxyethane	127	2377	Dimethyl sulfate	156	1595
1,2-Dimethoxyethane	127	2252	Dimethyl sulfide	130	1164
Dimethylamine, anhydrous	118	1032	Dimethyl sulphate	156	1595
Dimethylamine, aqueous solution	132	1160	Dimethyl sulphide	130	1164
Dimethylamine, solution	132	1160	Dimethyl thiophosphoryl chloride	156	2267
			Dimethylzinc	135	1370

Name of Material	Guide No.	ID No.	Name of Material	Guide No.	ID No.
Dinitroanilines	153	1596	Disinfectant, liquid, poisonous, n.o.s.	151	3142
Dinitrobenzenes, liquid	152	1597	Disinfectant, liquid, toxic, n.o.s.	151	3142
Dinitrobenzenes, solid	152	3443	Disinfectant, solid, poisonous, n.o.s.	151	1601
Dinitro-o-cresol	153	1598	Disinfectant, solid, toxic, n.o.s.	151	1601
Dinitrogen tetroxide	124	1067	Disodium trioxosilicate	154	3253
Dinitrogen tetroxide and Nitric oxide mixture	124	1975	Dispersant gas, n.o.s.	126	1078
Dinitrophenol, solution	153	1599	Dispersant gases, n.o.s. (flammable)	115	1954
Dinitrophenol, wetted with not less than 15% water	113	1320	Divinyl ether, stabilized	128P	1167
Dinitrophenolates, wetted with not less than 15% water	113	1321	DM	154	---
Dinitroresorcinol, wetted with not less than 15% water	113	1322	Dodecyltrichlorosilane	156	1771
Dinitrotoluenes, liquid	152	2038	DP	125	---
Dinitrotoluenes, molten	152	1600	Dry ice	120	1845
Dinitrotoluenes, solid	152	3454	Dye, liquid, corrosive, n.o.s.	154	2801
Dioxane	127	1165	Dye, liquid, poisonous, n.o.s.	151	1602
Dioxolane	127	1166	Dye, liquid, toxic, n.o.s.	151	1602
Dipentene	128	2052	Dye, solid, corrosive, n.o.s.	154	3147
Diphenylamine chloroarsine	154	1698	Dye, solid, poisonous, n.o.s.	151	3143
Diphenylchloroarsine, liquid	151	1699	Dye, solid, toxic, n.o.s.	151	3143
Diphenylchloroarsine, solid	151	3450	Dye intermediate, liquid, corrosive, n.o.s.	154	2801
Diphenyldichlorosilane	156	1769	Dye intermediate, liquid, poisonous, n.o.s.	151	1602
Diphenylmethyl bromide	153	1770	Dye intermediate, liquid, toxic, n.o.s.	151	1602
Dipicryl sulfide, wetted with not less than 10% water	113	2852	Dye intermediate, solid, corrosive, n.o.s.	154	3147
Dipicryl sulphide, wetted with not less than 10% water	113	2852	Dye intermediate, solid, poisonous, n.o.s.	151	3143
Dipropylamine	132	2383	Dye intermediate, solid, toxic, n.o.s.	151	3143
Di-n-propyl ether	127	2384	ED	151	---
Dipropyl ketone	128	2710			
Disinfectant, liquid, corrosive, n.o.s.	153	1903			

Name of Material	Guide No.	ID No.	Name of Material	Guide No.	ID No.
Elevated temperature liquid, flammable, n.o.s., with flash point above 37.8°C (100°F), at or above its flash point	128	3256	Esters, n.o.s.	127	3272
Elevated temperature liquid, flammable, n.o.s., with flash point above 60°C (140°F), at or above its flash point	128	3256	Ethane	115	1035
Elevated temperature liquid, n.o.s., at or above 100°C (212°F), and below its flash point	171	3257	Ethane, compressed	115	1035
Elevated temperature solid, n.o.s., at or above 240°C (464°F)	171	3258	Ethane, refrigerated liquid	115	1961
Engine, fuel cell, flammable gas powered	115	3166	Ethane-Propane mixture, refrigerated liquid	115	1961
Engine, fuel cell, flammable gas powered	115	3529	Ethanol	127	1170
Engine, fuel cell, flammable liquid powered	128	3166	Ethanol and gasoline mixture, with more than 10% ethanol	127	3475
Engine, fuel cell, flammable liquid powered	128	3528	Ethanol and motor spirit mixture, with more than 10% ethanol	127	3475
Engine, internal combustion	128	3166	Ethanol and petrol mixture, with more than 10% ethanol	127	3475
Engine, internal combustion	171	3530	Ethanol, solution	127	1170
Engine, internal combustion, flammable gas powered	115	3529	Ethanolamine	153	2491
Engine, internal combustion, flammable liquid powered	128	3528	Ethanolamine, solution	153	2491
Engines, internal combustion, flammable gas powered	115	3166	Ethers, n.o.s.	127	3271
Engines, internal combustion, flammable liquid powered	128	3166	Ethyl acetate	129	1173
Environmentally hazardous substance, liquid, n.o.s.	171	3082	Ethylacetylene, stabilized	116P	2452
Environmentally hazardous substance, solid, n.o.s.	171	3077	Ethyl acrylate, stabilized	129P	1917
Epibromohydrin	131	2558	Ethyl alcohol	127	1170
Epichlorohydrin	131P	2023	Ethyl alcohol, solution	127	1170
1,2-Epoxy-3-ethoxypropane	127	2752	Ethylamine	118	1036
			Ethylamine, aqueous solution, with not less than 50% but not more than 70% Ethylamine	132	2270
			Ethyl amyl ketone	128	2271
			2-Ethylaniline	153	2273
			N-Ethylaniline	153	2272
			Ethylbenzene	130	1175
			N-Ethyl-N-benzylaniline	153	2274
			N-Ethylbenzyltoluidines, liquid	153	2753
			N-Ethylbenzyltoluidines, solid	153	3460

Name of Material	Guide No.	ID No.	Name of Material	Guide No.	ID No.
Ethyl borate	129	1176	Ethylene glycol monoethyl ether	127	1171
Ethyl bromide	131	1891	Ethylene glycol monoethyl ether acetate	129	1172
Ethyl bromoacetate	155	1603	Ethylene glycol monomethyl ether	127	1188
2-Ethylbutanol	129	2275	Ethylene glycol monomethyl ether acetate	129	1189
2-Ethylbutyl acetate	130	1177	Ethyleneimine, stabilized	131P	1185
Ethyl butyl ether	127	1179	Ethylene oxide	119P	1040
2-Ethylbutyraldehyde	130	1178	Ethylene oxide and Carbon dioxide mixture, with more than 9% but not more than 87% Ethylene oxide	115	1041
Ethyl butyrate	130	1180	Ethylene oxide and Carbon dioxide mixture, with more than 87% Ethylene oxide	119P	3300
Ethyl chloride	115	1037	Ethylene oxide and Carbon dioxide mixtures, with not more than 9% Ethylene oxide	126	1952
Ethyl chloroacetate	155	1181	Ethylene oxide and Chlorotetrafluoroethane mixture, with not more than 8.8% Ethylene oxide	126	3297
Ethyl chloroformate	155	1182	Ethylene oxide and Dichlorodifluoromethane mixture, with not more than 12.5% Ethylene oxide	126	3070
Ethyl 2-chloropropionate	129	2935	Ethylene oxide and Pentafluoroethane mixture, with not more than 7.9% Ethylene oxide	126	3298
Ethyl chlorothioformate	155	2826	Ethylene oxide and Propylene oxide mixture, with not more than 30% Ethylene oxide	131P	2983
Ethyl crotonate	130	1862	Ethylene oxide and Tetrafluoroethane mixture, with not more than 5.6% Ethylene oxide	126	3299
Ethyl dichloroarsine	151	1892	Ethylene oxide with Nitrogen	119P	1040
Ethyl dichlorosilane	139	1183	Ethyl ether	127	1155
Ethylene	116P	1962	Ethyl fluoride	115	2453
Ethylene, Acetylene and Propylene in mixture, refrigerated liquid containing at least 71.5% Ethylene with not more than 22.5% Acetylene and not more than 6% Propylene	115	3138			
Ethylene, compressed	116P	1962			
Ethylene, refrigerated liquid (cryogenic liquid)	115	1038			
Ethylene chlorohydrin	131	1135			
Ethylenediamine	132	1604			
Ethylene dibromide	154	1605			
Ethylene dibromide and Methyl bromide mixture, liquid	151	1647			
Ethylene dichloride	131	1184			
Ethylene glycol diethyl ether	127	1153			

Name of Material	Guide No.	ID No.	Name of Material	Guide No.	ID No.
Ethyl formate	129	1190	Fabrics, animal or vegetable or synthetic, n.o.s. with oil	133	1373
Ethylhexaldehydes	129	1191	Fabrics impregnated with weakly nitrated Nitrocellulose, n.o.s.	133	1353
2-Ethylhexylamine	132	2276	Ferric arsenate	151	1606
2-Ethylhexyl chloroformate	156	2748	Ferric arsenite	151	1607
Ethyl isobutyrate	129	2385	Ferric chloride, anhydrous	157	1773
Ethyl isocyanate	155	2481	Ferric chloride, solution	154	2582
Ethyl lactate	129	1192	Ferric nitrate	140	1466
Ethyl mercaptan	129	2363	Ferrocerium	170	1323
Ethyl methacrylate, stabilized	130P	2277	Ferrosilicon	139	1408
Ethyl methyl ether	115	1039	Ferrous arsenate	151	1608
Ethyl methyl ketone	127	1193	Ferrous chloride, solid	154	1759
Ethyl nitrite, solution	131	1194	Ferrous chloride, solution	154	1760
Ethyl orthoformate	129	2524	Ferrous metal borings, shavings, turnings or cuttings	170	2793
Ethyl oxalate	156	2525	Fertilizer, ammoniating solution, with free Ammonia	125	1043
Ethylphenyldichlorosilane	156	2435	Fibers, animal or vegetable, burnt, wet or damp	133	1372
Ethyl phosphonothioic dichloride, anhydrous	154	2927	Fibers, animal or vegetable or synthetic, n.o.s. with oil	133	1373
Ethyl phosphonous dichloride, anhydrous	135	2845	Fibers, vegetable, dry	133	3360
Ethyl phosphorodichloridate	154	2927	Fibers impregnated with weakly nitrated Nitrocellulose, n.o.s.	133	1353
1-Ethylpiperidine	132	2386	Fibres, animal or vegetable, burnt, wet or damp	133	1372
Ethyl propionate	129	1195	Fibres, animal or vegetable or synthetic, n.o.s. with oil	133	1373
Ethyl propyl ether	127	2615	Fibres, vegetable, dry	133	3360
Ethyl silicate	129	1292	Fibres impregnated with weakly nitrated Nitrocellulose, n.o.s.	133	1353
N-Ethyltoluidines	153	2754	Fibres, animal or vegetable, burnt, wet or damp	133	1372
Ethyltrichlorosilane	155	1196	Fibres, animal or vegetable or synthetic, n.o.s. with oil	133	1373
Explosives, division 1.1, 1.2, 1.3 or 1.5	112	—	Fibres, vegetable, dry	133	3360
Explosives, division 1.4 or 1.6	114	—	Fibres impregnated with weakly nitrated Nitrocellulose, n.o.s.	133	1353
Extracts, aromatic, liquid	127	1169	Films, nitrocellulose base	133	1324
Extracts, flavoring, liquid	127	1197	Fire extinguisher charges, corrosive liquid	154	1774
Extracts, flavouring, liquid	127	1197			

Name of Material	Guide No.	ID No.	Name of Material	Guide No.	ID No.
Fire extinguishers with compressed or liquefied gas	126	1044	Flammable solid, toxic, organic, n.o.s.	134	2926
Firelighters, solid, with flammable liquid	133	2623	Fluorine	124	1045
First aid kit	171	3316	Fluorine, compressed	124	1045
Fish meal, stabilized	171	2216	Fluoroacetic acid	154	2642
Fish meal, unstabilized	133	1374	Fluoroanilines	153	2941
Fish scrap, stabilized	171	2216	Fluorobenzene	130	2387
Fish scrap, unstabilized	133	1374	Fluoroboric acid	154	1775
Flammable liquid, corrosive, n.o.s.	132	2924	Fluorophosphoric acid, anhydrous	154	1776
Flammable liquid, n.o.s.	128	1993	Fluorosilicates, n.o.s.	151	2856
Flammable liquid, poisonous, corrosive, n.o.s.	131	3286	Fluorosilicic acid	154	1778
Flammable liquid, poisonous, n.o.s.	131	1992	Fluorosulfonic acid	137	1777
Flammable liquid, toxic, corrosive, n.o.s.	131	3286	Fluorosulphonic acid	137	1777
Flammable liquid, toxic, n.o.s.	131	1992	Fluorotoluenes	130	2388
Flammable solid, corrosive, inorganic, n.o.s.	134	3180	Formaldehyde, solution (corrosive)	153	2209
Flammable solid, corrosive, organic, n.o.s.	134	2925	Formaldehyde, solution, flammable	132	1198
Flammable solid, inorganic, n.o.s.	133	3178	Formalin (corrosive)	153	2209
Flammable solid, organic, molten, n.o.s.	133	3176	Formalin (flammable)	132	1198
Flammable solid, organic, n.o.s.	133	1325	Formic acid	153	1779
Flammable solid, oxidizing, n.o.s.	140	3097	Formic acid, with more than 85% acid	153	1779
Flammable solid, poisonous, inorganic, n.o.s.	134	3179	Formic acid, with not less than 5% but less than 10% acid	153	3412
Flammable solid, poisonous, organic, n.o.s.	134	2926	Formic acid, with not less than 10% but not more than 85% acid	153	3412
Flammable solid, toxic, inorganic, n.o.s.	134	3179	Fuel, aviation, turbine engine	128	1863
			Fuel cell cartridges, containing corrosive substances	153	3477
			Fuel cell cartridges, containing flammable liquids	128	3473
			Fuel cell cartridges, containing hydrogen in metal hydride	115	3479

Name of Material	Guide No.	ID No.	Name of Material	Guide No.	ID No.
Fuel cell cartridges, containing liquefied flammable gas	115	3478	Furfurylamine	132	2526
Fuel cell cartridges, containing water-reactive substances	138	3476	Fusee (railway or highway)	133	1325
Fuel cell cartridges contained in equipment, containing corrosive substances	153	3477	Fusel oil	127	1201
Fuel cell cartridges contained in equipment, containing flammable liquids	128	3473	GA	153	—
Fuel cell cartridges contained in equipment, containing hydrogen in metal hydride	115	3479	Gallium	172	2803
Fuel cell cartridges contained in equipment, containing liquefied flammable gas	115	3478	Gas, refrigerated liquid, flammable, n.o.s.	115	3312
Fuel cell cartridges contained in equipment, containing water-reactive substances	138	3476	Gas, refrigerated liquid, n.o.s.	120	3158
Fuel cell cartridges packed with equipment, containing corrosive substances	153	3477	Gas, refrigerated liquid, oxidizing, n.o.s.	122	3311
Fuel cell cartridges packed with equipment, containing flammable liquids	128	3473	Gas cartridges	115	2037
Fuel cell cartridges packed with equipment, containing hydrogen in metal hydride	115	3479	Gas identification set	123	9035
Fuel cell cartridges packed with equipment, containing liquefied flammable gas	115	3478	Gasohol	128	1203
Fuel cell cartridges packed with equipment, containing water-reactive substances	138	3476	Gas oil	128	1202
Fuel cell cartridges packed with equipment, containing corrosive substances	153	3477	Gasoline	128	1203
Fuel cell cartridges packed with equipment, containing flammable liquids	128	3473	Gasoline and ethanol mixture, with more than 10% ethanol	127	3475
Fuel cell cartridges packed with equipment, containing hydrogen in metal hydride	115	3479	Gas sample, non-pressurized, flammable, n.o.s., not refrigerated liquid	115	3167
Fuel cell cartridges packed with equipment, containing liquefied flammable gas	115	3478	Gas sample, non-pressurized, poisonous, flammable, n.o.s., not refrigerated liquid	119	3168
Fuel cell cartridges packed with equipment, containing water-reactive substances	138	3476	Gas sample, non-pressurized, poisonous, n.o.s., not refrigerated liquid	123	3169
Fuel oil	128	1202	Gas sample, non-pressurized, toxic, flammable, n.o.s., not refrigerated liquid	119	3168
Fuel oil	128	1993	Gas sample, non-pressurized, toxic, n.o.s., not refrigerated liquid	123	3169
Fumaryl chloride	156	1780	GB	153	—
Fumigated cargo transport unit	171	3359	GD	153	—
Furaldehydes	153P	1199	Genetically modified micro-organisms	171	3245
Furan	128	2389	Genetically modified organisms	171	3245
Furfuryl alcohol	153	2874			

Name of Material **Guide ID**
No. **No.**

Germane	119	2192
Germane, adsorbed	173	3523
GF	153	—
Glycerol alpha-monochlorohydrin	153	2689
Glycidaldehyde	131P	2622
Guanidine nitrate	143	1467
H	153	—
Hafnium powder, dry	135	2545
Hafnium powder, wetted with not less than 25% water	170	1326
Halogenated monomethyldiphenylmethanes, liquid	171	3151
Halogenated monomethyldiphenylmethanes, solid	171	3152
Hay, wet, damp or contaminated with oil	133	1327
Hazardous waste, liquid, n.o.s.	171	3082
Hazardous waste, solid, n.o.s.	171	3077
HD	153	—
Heating oil, light	128	1202
Helium	120	1046
Helium, compressed	120	1046
Helium, refrigerated liquid (cryogenic liquid)	120	1963
Heptafluoropropane	126	3296
n-Heptaldehyde	129	3056
Heptanes	128	1206
n-Heptene	128	2278
Hexachloroacetone	153	2661
Hexachlorobenzene	152	2729
Hexachlorobutadiene	151	2279
Hexachlorocyclopentadiene	151	2646

Name of Material **Guide ID**
No. **No.**

Hexachlorophene	151	2875
Hexadecyltrichlorosilane	156	1781
Hexadiene	130	2458
Hexaethyl tetraphosphate	151	1611
Hexaethyl tetraphosphate and compressed gas mixture	123	1612
Hexafluoroacetone	125	2420
Hexafluoroacetone hydrate, liquid	151	2552
Hexafluoroacetone hydrate, solid	151	3436
Hexafluoroethane	126	2193
Hexafluoroethane, compressed	126	2193
Hexafluorophosphoric acid	154	1782
Hexafluoropropylene	126	1858
Hexafluoropropylene, compressed	126	1858
Hexaldehyde	130	1207
Hexamethylenediamine, solid	153	2280
Hexamethylenediamine, solution	153	1783
Hexamethylene diisocyanate	156	2281
Hexamethyleneimine	132	2493
Hexamethylenetetramine	133	1328
Hexanes	128	1208
Hexanoic acid	153	2829
Hexanols	129	2282
1-Hexene	128	2370
Hexyltrichlorosilane	156	1784
HL	153	—
HN-1	153	—
HN-2	153	—
HN-3	153	—
Hydrazine, anhydrous	132	2029

Name of Material	Guide No.	ID No.	Name of Material	Guide No.	ID No.
Hydrazine aqueous solution, flammable, with more than 37% hydrazine, by mass	132	3484	Hydrogen in a metal hydride storage system contained in equipment	115	3468
Hydrazine, aqueous solution, with more than 37% Hydrazine	153	2030	Hydrogen in a metal hydride storage system packed with equipment	115	3468
Hydrazine, aqueous solution, with not more than 37% Hydrazine	152	3293	Hydrogen, refrigerated liquid (cryogenic liquid)	115	1966
Hydriodic acid	154	1787	Hydrogen and Methane mixture, compressed	115	2034
Hydrobromic acid	154	1788	Hydrogen bromide, anhydrous	125	1048
Hydrocarbon and butadienes mixture, stabilized	116P	1010	Hydrogen chloride, anhydrous	125	1050
Hydrocarbon gas mixture, compressed, n.o.s.	115	1964	Hydrogen chloride, refrigerated liquid	125	2186
Hydrocarbon gas mixture, liquefied, n.o.s.	115	1965	Hydrogen cyanide, anhydrous, stabilized	117P	1051
Hydrocarbon gas refills for small devices, with release device	115	3150	Hydrogen cyanide, aqueous solution, with not more than 20% Hydrogen cyanide	154	1613
Hydrocarbons, liquid, n.o.s.	128	3295	Hydrogen cyanide, solution in alcohol, with not more than 45% Hydrogen cyanide	131	3294
Hydrochloric acid	157	1789	Hydrogen cyanide, stabilized	117P	1051
Hydrocyanic acid, aqueous solution, with less than 5% Hydrogen cyanide	154	1613	Hydrogen cyanide, stabilized (absorbed)	152	1614
Hydrocyanic acid, aqueous solution, with not more than 20% Hydrogen cyanide	154	1613	Hydrogendifluorides, solid, n.o.s.	154	1740
Hydrofluoric acid	157	1790	Hydrogendifluorides, solution, n.o.s.	154	3471
Hydrofluoric acid and Sulfuric acid mixture	157	1786	Hydrogen fluoride, anhydrous	125	1052
Hydrofluoric acid and Sulphuric acid mixture	157	1786	Hydrogen iodide, anhydrous	125	2197
Hydrofluorosilicic acid	154	1778	Hydrogen peroxide, aqueous solution, stabilized, with more than 60% Hydrogen peroxide	143	2015
Hydrogen	115	1049	Hydrogen peroxide, aqueous solution, with not less than 8% but less than 20% Hydrogen peroxide	140	2984
Hydrogen, compressed	115	1049			
Hydrogen in a metal hydride storage system	115	3468			

Name of Material	Guide No.	ID No.	Name of Material	Guide No.	ID No.
Hydrogen peroxide, aqueous solution, with not less than 20% but not more than 60% Hydrogen peroxide (stabilized as necessary)	140	2014	Insecticide gas, poisonous, flammable, n.o.s. (Inhalation Hazard Zone B)	119	3355
Hydrogen peroxide, stabilized	143	2015	Insecticide gas, poisonous, flammable, n.o.s. (Inhalation Hazard Zone C)	119	3355
Hydrogen peroxide and Peroxyacetic acid mixture, with acid(s), water and not more than 5% Peroxyacetic acid, stabilized	140	3149	Insecticide gas, poisonous, flammable, n.o.s. (Inhalation Hazard Zone D)	119	3355
Hydrogen selenide, adsorbed	173	3526	Insecticide gas, poisonous, n.o.s.	123	1967
Hydrogen selenide, anhydrous	117	2202	Insecticide gas, toxic, flammable, n.o.s.	119	3355
Hydrogen sulfide	117	1053	Insecticide gas, toxic, flammable, n.o.s. (Inhalation Hazard Zone A)	119	3355
Hydrogen sulphide	117	1053	Insecticide gas, toxic, flammable, n.o.s. (Inhalation Hazard Zone B)	119	3355
1-Hydroxybenzotriazole, anhydrous, wetted with not less than 20% water	113	3474	Insecticide gas, toxic, flammable, n.o.s. (Inhalation Hazard Zone C)	119	3355
1-Hydroxybenzotriazole, monohydrate	113	3474	Insecticide gas, toxic, flammable, n.o.s. (Inhalation Hazard Zone D)	119	3355
Hydroxylamine sulfate	154	2865	Insecticide gas, toxic, n.o.s.	123	1967
Hydroxylamine sulphate	154	2865	Iodine	154	3495
Hypochlorite solution	154	1791	Iodine monochloride, liquid	157	3498
Hypochlorites, inorganic, n.o.s.	140	3212	Iodine monochloride, solid	157	1792
3,3'-Iminodipropylamine	153	2269	Iodine pentafluoride	144	2495
Infectious substance, affecting animals only	158	2900	2-Iodobutane	129	2390
Infectious substance, affecting humans	158	2814	Iodomethylpropanes	129	2391
Ink, printer's, flammable	129	1210	Iodopropanes	129	2392
Insecticide gas, flammable, n.o.s.	115	3354	Iron oxide, spent	135	1376
Insecticide gas, n.o.s.	126	1968	Iron pentacarbonyl	136	1994
Insecticide gas, poisonous, flammable, n.o.s.	119	3355	Iron sponge, spent	135	1376
Insecticide gas, poisonous, flammable, n.o.s. (Inhalation Hazard Zone A)	119	3355	Isobutane	115	1075
			Isobutane	115	1969

Name of Material **Guide ID**
No. **No.**

Name of Material **Guide ID**
No. **No.**

Isobutanol	129	1212
Isobutyl acetate	129	1213
Isobutyl acrylate, stabilized	129P	2527
Isobutyl alcohol	129	1212
Isobutyl aldehyde	130	2045
Isobutylamine	132	1214
Isobutyl chloroformate	155	2742
Isobutylene	115	1055
Isobutylene	115	1075
Isobutyl formate	129	2393
Isobutyl isobutyrate	130	2528
Isobutyl isocyanate	155P	2486
Isobutyl methacrylate, stabilized	130P	2283
Isobutyl propionate	129	2394
Isobutyraldehyde	130	2045
Isobutyric acid	132	2529
Isobutyronitrile	131	2284
Isobutyryl chloride	132	2395
Isocyanate solution, flammable, poisonous, n.o.s.	155	2478
Isocyanate solution, flammable, toxic, n.o.s.	155	2478
Isocyanate solution, poisonous, flammable, n.o.s.	155	3080
Isocyanate solution, poisonous, n.o.s.	155	2206
Isocyanate solution, toxic, flammable, n.o.s.	155	3080
Isocyanate solution, toxic, n.o.s.	155	2206
Isocyanates, flammable, poisonous, n.o.s.	155	2478
Isocyanates, flammable, toxic, n.o.s.	155	2478

Isocyanates, poisonous, flammable, n.o.s.	155	3080
Isocyanates, poisonous, n.o.s.	155	2206
Isocyanates, toxic, flammable, n.o.s.	155	3080
Isocyanates, toxic, n.o.s.	155	2206
Isocyanatobenzotrifluorides	156	2285
Isoheptenes	128	2287
Isohexenes	128	2288
Isooctane	128	1262
Isooctenes	128	1216
Isopentane	128	1265
Isopentenes	128	2371
Isophoronediamine	153	2289
Isophorone diisocyanate	156	2290
Isoprene, stabilized	130P	1218
Isopropanol	129	1219
Isopropenyl acetate	129P	2403
Isopropenylbenzene	128	2303
Isopropyl acetate	129	1220
Isopropyl acid phosphate	153	1793
Isopropyl alcohol	129	1219
Isopropylamine	132	1221
Isopropylbenzene	130	1918
Isopropyl butyrate	129	2405
Isopropyl chloroacetate	155	2947
Isopropyl chloroformate	155	2407
Isopropyl 2-chloropropionate	129	2934
Isopropyl isobutyrate	127	2406
Isopropyl isocyanate	155P	2483
Isopropyl nitrate	130	1222
Isopropyl propionate	129	2409
Isosorbide dinitrate mixture	133	2907

Name of Material	Guide No.	ID No.	Name of Material	Guide No.	ID No.
Isosorbide-5-mononitrate	133	3251	Liquefied gas, flammable, n.o.s.	115	3161
Kerosene	128	1223	Liquefied gas, n.o.s.	126	3163
Ketones, liquid, n.o.s.	127	1224	Liquefied gas, oxidizing, n.o.s.	122	3157
Krill meal	133	3497	Liquefied gas, poisonous, corrosive, n.o.s.	125	3308
Krypton	120	1056	Liquefied gas, poisonous, corrosive, n.o.s. (Inhalation Hazard Zone A)	125	3308
Krypton, compressed	120	1056	Liquefied gas, poisonous, corrosive, n.o.s. (Inhalation Hazard Zone B)	125	3308
Krypton, refrigerated liquid (cryogenic liquid)	120	1970	Liquefied gas, poisonous, corrosive, n.o.s. (Inhalation Hazard Zone C)	125	3308
L (Lewisite)	153	—	Liquefied gas, poisonous, flammable, corrosive, n.o.s. (Inhalation Hazard Zone A)	119	3309
Lead acetate	151	1616	Liquefied gas, poisonous, flammable, corrosive, n.o.s. (Inhalation Hazard Zone B)	119	3309
Lead arsenates	151	1617	Liquefied gas, poisonous, flammable, corrosive, n.o.s. (Inhalation Hazard Zone C)	119	3309
Lead arsenites	151	1618	Liquefied gas, poisonous, flammable, corrosive, n.o.s. (Inhalation Hazard Zone D)	119	3309
Lead compound, soluble, n.o.s.	151	2291	Liquefied gas, poisonous, flammable, n.o.s. (Inhalation Hazard Zone A)	119	3309
Lead cyanide	151	1620	Liquefied gas, poisonous, flammable, corrosive, n.o.s. (Inhalation Hazard Zone B)	119	3309
Lead dioxide	140	1872	Liquefied gas, poisonous, flammable, corrosive, n.o.s. (Inhalation Hazard Zone C)	119	3309
Lead nitrate	141	1469	Liquefied gas, poisonous, flammable, corrosive, n.o.s. (Inhalation Hazard Zone D)	119	3309
Lead perchlorate, solid	141	1470	Liquefied gas, poisonous, flammable, n.o.s. (Inhalation Hazard Zone A)	119	3309
Lead perchlorate, solution	141	3408	Liquefied gas, poisonous, flammable, corrosive, n.o.s. (Inhalation Hazard Zone B)	119	3309
Lead phosphite, dibasic	133	2989	Liquefied gas, poisonous, flammable, corrosive, n.o.s. (Inhalation Hazard Zone C)	119	3309
Lead sulfate, with more than 3% free acid	154	1794	Liquefied gas, poisonous, flammable, corrosive, n.o.s. (Inhalation Hazard Zone D)	119	3309
Lead sulphate, with more than 3% free acid	154	1794	Liquefied gas, poisonous, flammable, n.o.s. (Inhalation Hazard Zone A)	119	3160
Lewisite	153	—	Liquefied gas, poisonous, flammable, n.o.s. (Inhalation Hazard Zone B)	119	3160
Life-saving appliances, not self-inflating	171	3072	Liquefied gas, poisonous, flammable, n.o.s. (Inhalation Hazard Zone C)	119	3160
Life-saving appliances, self-inflating	171	2990	Liquefied gas, poisonous, flammable, n.o.s. (Inhalation Hazard Zone D)	119	3160
Lighter refills containing flammable gas	115	1057	Liquefied gas, poisonous, flammable, n.o.s. (Inhalation Hazard Zone A)	119	3160
Lighters containing flammable gas	115	1057	Liquefied gas, poisonous, flammable, n.o.s. (Inhalation Hazard Zone B)	119	3160
Lighters, non-pressurized, containing flammable liquid	128	1057	Liquefied gas, poisonous, flammable, n.o.s. (Inhalation Hazard Zone C)	119	3160

Name of Material **Guide ID**
No. **No.**

Name of Material **Guide ID**
No. **No.**

Liquefied gas, poisonous, flammable, n.o.s. (Inhalation Hazard Zone C) **119** 3160

Liquefied gas, poisonous, flammable, n.o.s. (Inhalation Hazard Zone D) **119** 3160

Liquefied gas, poisonous, n.o.s. **123** 3162

Liquefied gas, poisonous, n.o.s. (Inhalation Hazard Zone A) **123** 3162

Liquefied gas, poisonous, n.o.s. (Inhalation Hazard Zone B) **123** 3162

Liquefied gas, poisonous, n.o.s. (Inhalation Hazard Zone C) **123** 3162

Liquefied gas, poisonous, n.o.s. (Inhalation Hazard Zone D) **123** 3162

Liquefied gas, poisonous, oxidizing, corrosive, n.o.s. **124** 3310

Liquefied gas, poisonous, oxidizing, corrosive, n.o.s. (Inhalation Hazard Zone A) **124** 3310

Liquefied gas, poisonous, oxidizing, corrosive, n.o.s. (Inhalation Hazard Zone B) **124** 3310

Liquefied gas, poisonous, oxidizing, corrosive, n.o.s. (Inhalation Hazard Zone C) **124** 3310

Liquefied gas, poisonous, oxidizing, corrosive, n.o.s. (Inhalation Hazard Zone D) **124** 3310

Liquefied gas, poisonous, oxidizing, n.o.s. **124** 3307

Liquefied gas, poisonous, oxidizing, n.o.s. (Inhalation Hazard Zone A) **124** 3307

Liquefied gas, poisonous, oxidizing, n.o.s. (Inhalation Hazard Zone B) **124** 3307

Liquefied gas, poisonous, oxidizing, n.o.s. (Inhalation Hazard Zone C) **124** 3307

Liquefied gas, poisonous, oxidizing, n.o.s. (Inhalation Hazard Zone D) **124** 3307

Liquefied gas, toxic, corrosive, n.o.s. **125** 3308

Liquefied gas, toxic, corrosive, n.o.s. (Inhalation Hazard Zone A) **125** 3308

Liquefied gas, toxic, corrosive, n.o.s. (Inhalation Hazard Zone B) **125** 3308

Liquefied gas, toxic, corrosive, n.o.s. (Inhalation Hazard Zone C) **125** 3308

Liquefied gas, toxic, corrosive, n.o.s. (Inhalation Hazard Zone D) **125** 3308

Liquefied gas, toxic, flammable, corrosive, n.o.s. **119** 3309

Liquefied gas, toxic, flammable, corrosive, n.o.s. (Inhalation Hazard Zone A) **119** 3309

Liquefied gas, toxic, flammable, corrosive, n.o.s. (Inhalation Hazard Zone B) **119** 3309

Liquefied gas, toxic, flammable, corrosive, n.o.s. (Inhalation Hazard Zone C) **119** 3309

Liquefied gas, toxic, flammable, corrosive, n.o.s. (Inhalation Hazard Zone D) **119** 3309

Liquefied gas, toxic, flammable, n.o.s. **119** 3160

Liquefied gas, toxic, flammable, n.o.s. (Inhalation Hazard Zone A) **119** 3160

Liquefied gas, toxic, flammable, n.o.s. (Inhalation Hazard Zone B) **119** 3160

Name of Material **Guide ID**
 No. No.

Liquefied gas, toxic, flammable, n.o.s. (Inhalation Hazard Zone C)	119	3160
Liquefied gas, toxic, flammable, n.o.s. (Inhalation Hazard Zone D)	119	3160
Liquefied gas, toxic, n.o.s.	123	3162
Liquefied gas, toxic, n.o.s. (Inhalation Hazard Zone A)	123	3162
Liquefied gas, toxic, n.o.s. (Inhalation Hazard Zone B)	123	3162
Liquefied gas, toxic, n.o.s. (Inhalation Hazard Zone C)	123	3162
Liquefied gas, toxic, n.o.s. (Inhalation Hazard Zone D)	123	3162
Liquefied gas, toxic, oxidizing, corrosive, n.o.s.	124	3310
Liquefied gas, toxic, oxidizing, corrosive, n.o.s. (Inhalation Hazard Zone A)	124	3310
Liquefied gas, toxic, oxidizing, corrosive, n.o.s. (Inhalation Hazard Zone B)	124	3310
Liquefied gas, toxic, oxidizing, corrosive, n.o.s. (Inhalation Hazard Zone C)	124	3310
Liquefied gas, toxic, oxidizing, corrosive, n.o.s. (Inhalation Hazard Zone D)	124	3310
Liquefied gas, toxic, oxidizing, n.o.s.	124	3307
Liquefied gas, toxic, oxidizing, n.o.s. (Inhalation Hazard Zone A)	124	3307
Liquefied gas, toxic, oxidizing, n.o.s. (Inhalation Hazard Zone B)	124	3307
Liquefied gas, toxic, oxidizing, n.o.s. (Inhalation Hazard Zone C)	124	3307

Name of Material **Guide ID**
 No. No.

Liquefied gas, toxic, oxidizing, n.o.s. (Inhalation Hazard Zone D)	124	3307
Liquefied gases, non-flammable, charged with Nitrogen, Carbon dioxide or Air	120	1058
Liquefied natural gas (cryogenic liquid)	115	1972
Liquefied petroleum gas	115	1075
Lithium	138	1415
Lithium aluminum hydride	138	1410
Lithium aluminum hydride, ethereal	138	1411
Lithium batteries	138	3090
Lithium batteries contained in equipment	138	3091
Lithium batteries installed in cargo transport unit (lithium ion batteries)	147	3536
Lithium batteries installed in cargo transport unit (lithium metal batteries)	138	3536
Lithium batteries packed with equipment	138	3091
Lithium borohydride	138	1413
Lithium ferrosilicon	139	2830
Lithium hydride	138	1414
Lithium hydride, fused solid	138	2805
Lithium hydroxide	154	2680
Lithium hydroxide, solution	154	2679
Lithium hypochlorite, dry	140	1471
Lithium hypochlorite mixture	140	1471
Lithium hypochlorite mixtures, dry	140	1471
Lithium ion batteries (including lithium ion polymer batteries)	147	3480

Name of Material	Guide No.	ID No.	Name of Material	Guide No.	ID No.
Lithium ion batteries contained in equipment (including lithium ion polymer batteries)	147	3481	Magnesium alloys, with more than 50% Magnesium, in pellets, turnings or ribbons	138	1869
Lithium ion batteries packed with equipment (including lithium ion polymer batteries)	147	3481	Magnesium alloys powder	138	1418
Lithium metal batteries (including lithium alloy batteries)	138	3090	Magnesium aluminum phosphide	139	1419
Lithium metal batteries contained in equipment (including lithium alloy batteries)	138	3091	Magnesium arsenate	151	1622
Lithium metal batteries packed with equipment (including lithium alloy batteries)	138	3091	Magnesium bromate	140	1473
Lithium nitrate	140	2722	Magnesium chlorate	140	2723
Lithium nitride	139	2806	Magnesium chloride and Chlorate mixture, solid	140	1459
Lithium peroxide	143	1472	Magnesium chloride and Chlorate mixture, solution	140	3407
Lithium silicon	138	1417	Magnesium diamide	135	2004
LNG (cryogenic liquid)	115	1972	Magnesium diphenyl	135	2005
London purple	151	1621	Magnesium fluorosilicate	151	2853
LPG	115	1075	Magnesium granules, coated	138	2950
Machinery, fuel cell, flammable gas powered	115	3529	Magnesium hydride	138	2010
Machinery, fuel cell, flammable liquid powered	128	3528	Magnesium nitrate	140	1474
Machinery, internal combustion	171	3530	Magnesium perchlorate	140	1475
Machinery, internal combustion, flammable gas powered	115	3529	Magnesium peroxide	140	1476
Machinery, internal combustion, flammable liquid powered	128	3528	Magnesium phosphide	139	2011
Magnesium	138	1869	Magnesium powder	138	1418
Magnesium, in pellets, turnings or ribbons	138	1869	Magnesium silicide	138	2624
Magnesium alkyls	135	3053	Magnetized material	171	2807
			Maleic anhydride	156	2215
			Maleic anhydride, molten	156	2215
			Malononitrile	153	2647
			Maneb	135	2210
			Maneb, stabilized	135	2968
			Maneb preparation, stabilized	135	2968
			Maneb preparation, with not less than 60% Maneb	135	2210
			Manganese nitrate	140	2724

Name of Material	Guide No.	ID No.	Name of Material	Guide No.	ID No.
Manganese resinate	133	1330	Mercaptans, liquid, poisonous, flammable, n.o.s.	131	3071
Matches, fusee	133	2254	Mercaptans, liquid, toxic, flammable, n.o.s.	131	3071
Matches, safety	133	1944	Mercuric arsenate	151	1623
Matches, "strike anywhere"	133	1331	Mercuric chloride	154	1624
Matches, wax "vesta"	133	1945	Mercuric nitrate	141	1625
MD	152	—	Mercuric potassium cyanide	157	1626
Medical waste, category A, affecting animals only, solid	158	3549	Mercurous nitrate	141	1627
Medical waste, category A, affecting humans, solid	158	3549	Mercury	172	2809
Medical waste, n.o.s.	158	3291	Mercury acetate	151	1629
Medicine, liquid, flammable, poisonous, n.o.s.	131	3248	Mercury ammonium chloride	151	1630
Medicine, liquid, flammable, toxic, n.o.s.	131	3248	Mercury based pesticide, liquid, flammable, poisonous	131	2778
Medicine, liquid, poisonous, n.o.s.	151	1851	Mercury based pesticide, liquid, flammable, toxic	131	2778
Medicine, liquid, toxic, n.o.s.	151	1851	Mercury based pesticide, liquid, poisonous	151	3012
Medicine, solid, poisonous, n.o.s.	151	3249	Mercury based pesticide, liquid, poisonous, flammable	131	3011
Medicine, solid, toxic, n.o.s.	151	3249	Mercury based pesticide, liquid, toxic	151	3012
Mercaptan mixture, liquid, flammable, n.o.s.	130	3336	Mercury based pesticide, liquid, toxic, flammable	131	3011
Mercaptan mixture, liquid, flammable, poisonous, n.o.s.	131	1228	Mercury based pesticide, solid, poisonous	151	2777
Mercaptan mixture, liquid, flammable, toxic, n.o.s.	131	1228	Mercury based pesticide, solid, toxic	151	2777
Mercaptan mixture, liquid, poisonous, flammable, n.o.s.	131	3071	Mercury benzoate	154	1631
Mercaptan mixture, liquid, toxic, flammable, n.o.s.	131	3071	Mercury bromides	154	1634
Mercaptans, liquid, flammable, n.o.s.	130	3336	Mercury compound, liquid, n.o.s.	151	2024
Mercaptans, liquid, flammable, poisonous, n.o.s.	131	1228	Mercury compound, solid, n.o.s.	151	2025
Mercaptans, liquid, flammable, toxic, n.o.s.	131	1228	Mercury contained in manufactured articles	172	3506
			Mercury cyanide	154	1636

Name of Material	Guide No.	ID No.	Name of Material	Guide No.	ID No.
Mercury gluconate	151	1637	Methacrylonitrile, stabilized	131P	3079
Mercury iodide	151	1638	Methallyl alcohol	129	2614
Mercury nucleate	151	1639	Methane	115	1971
Mercury oleate	151	1640	Methane, compressed	115	1971
Mercury oxide	151	1641	Methane, refrigerated liquid (cryogenic liquid)	115	1972
Mercury oxycyanide, desensitized	151	1642	Methane and Hydrogen mixture, compressed	115	2034
Mercury potassium iodide	151	1643	Methanesulfonyl chloride	156	3246
Mercury salicylate	151	1644	Methanesulphonyl chloride	156	3246
Mercury sulfate	151	1645	Methanol	131	1230
Mercury sulphate	151	1645	Methoxymethyl isocyanate	155	2605
Mercury thiocyanate	151	1646	4-Methoxy-4-methylpentan-2-one	128	2293
Mesityl oxide	129	1229	1-Methoxy-2-propanol	129	3092
Metal carbonyls, liquid, n.o.s.	151	3281	Methyl acetate	129	1231
Metal carbonyls, solid, n.o.s.	151	3466	Methylacetylene and Propadiene mixture, stabilized	116P	1060
Metal catalyst, dry	135	2881	Methyl acrylate, stabilized	129P	1919
Metal catalyst, wetted	170	1378	Methylal	127	1234
Metaldehyde	133	1332	Methyl alcohol	131	1230
Metal hydrides, flammable, n.o.s.	170	3182	Methylallyl chloride	130P	2554
Metal hydrides, water-reactive, n.o.s.	138	1409	Methylamine, anhydrous	118	1061
Metallic substance, water-reactive, n.o.s.	138	3208	Methylamine, aqueous solution	132	1235
Metallic substance, water-reactive, self-heating, n.o.s.	138	3209	Methylamyl acetate	130	1233
Metal powder, flammable, n.o.s.	170	3089	Methylamyl alcohol	129	2053
Metal powder, self-heating, n.o.s.	135	3189	Methyl amyl ketone	127	1110
Metal salts of organic compounds, flammable, n.o.s.	133	3181	N-Methylaniline	153	2294
Methacrylaldehyde, stabilized	131P	2396	Methylbenzyl (alpha) alcohol, liquid	153	2937
Methacrylic acid, stabilized	153P	2531	Methylbenzyl (alpha) alcohol, solid	153	3438
			Methyl bromide	123	1062

Name of Material	Guide No.	ID No.	Name of Material	Guide No.	ID No.
Methyl bromide and Chloropicrin mixture	123	1581	Methyl ethyl ketone	127	1193
Methyl bromide and Ethylene dibromide mixture, liquid	151	1647	2-Methyl-5-ethylpyridine	153	2300
Methyl bromoacetate	155	2643	Methyl fluoride	115	2454
2-Methylbutanal	129	3371	Methyl formate	129	1243
3-Methylbutan-2-one	127	2397	2-Methylfuran	128	2301
2-Methyl-1-butene	128	2459	2-Methyl-2-heptanethiol	131	3023
2-Methyl-2-butene	128	2460	5-Methylhexan-2-one	127	2302
3-Methyl-1-butene	128	2561	Methylhydrazine	131	1244
N-Methylbutylamine	132	2945	Methyl iodide	151	2644
Methyl tert-butyl ether	127	2398	Methyl isobutyl carbinol	129	2053
Methyl butyrate	129	1237	Methyl isobutyl ketone	127	1245
Methyl chloride	115	1063	Methyl isocyanate	155P	2480
Methyl chloride and Chloropicrin mixture	119	1582	Methyl isopropenyl ketone, stabilized	127P	1246
Methyl chloride and Methylene chloride mixture	115	1912	Methyl isothiocyanate	131	2477
Methyl chloroacetate	155	2295	Methyl isovalerate	130	2400
Methyl chloroformate	155	1238	Methyl magnesium bromide in Ethyl ether	138	1928
Methyl chloromethyl ether	131	1239	Methyl mercaptan	117	1064
Methyl 2-chloropropionate	129	2933	Methyl methacrylate monomer, stabilized	129P	1247
Methylchlorosilane	119	2534	4-Methylmorpholine	132	2535
Methylcyclohexane	128	2296	N-Methylmorpholine	132	2535
Methylcyclohexanols	129	2617	Methyl nitrite	116	2455
Methylcyclohexanone	128	2297	Methyl orthosilicate	155	2606
Methylcyclopentane	128	2298	Methylpentadiene	128	2461
Methyl dichloroacetate	155	2299	2-Methylpentan-2-ol	129	2560
Methyldichloroarsine	152	1556	Methylphenyldichlorosilane	156	2437
Methyldichlorosilane	139	1242	Methyl phosphonic dichloride	137	9206
Methylene chloride	160	1593	Methyl phosphonous dichloride	135	2845
Methylene chloride and Methyl chloride mixture	115	1912	1-Methylpiperidine	132	2399
Methyl ethyl ether	115	1039	Methyl propionate	129	1248
			Methyl propyl ether	127	2612

Name of Material	Guide No.	ID No.	Name of Material	Guide No.	ID No.
Methyl propyl ketone	127	1249	Natural gas, refrigerated liquid (cryogenic liquid)	115	1972
Methyltetrahydrofuran	127	2536	Neohexane	128	1208
Methyl trichloroacetate	156	2533	Neon	120	1065
Methyltrichlorosilane	155	1250	Neon, compressed	120	1065
Methyl valeraldehyde (alpha)	130	2367	Neon, refrigerated liquid (cryogenic liquid)	120	1913
Methyl vinyl ketone, stabilized	131P	1251	Nickel carbonyl	131	1259
Molten sulfur	133	2448	Nickel catalyst, dry	135	2881
Molten sulphur	133	2448	Nickel cyanide	151	1653
Molybdenum pentachloride	156	2508	Nickel cyanide	151	1653
Monoethanolamine	153	2491	Nickel nitrate	140	2725
Mononitrotoluidines	153	2660	Nickel nitrate	140	2726
Morpholine	132	2054	Nickel nitrite	140	2726
Motor fuel anti-knock mixture	152	1649	Nicotine	151	1654
Motor fuel anti-knock mixture, flammable	131	3483	Nicotine compound, liquid, n.o.s.	151	3144
Motor spirit	128	1203	Nicotine compound, solid, n.o.s.	151	1655
Motor spirit and ethanol mixture, with more than 10% ethanol	127	3475	Nicotine hydrochloride, liquid	151	1656
Muriatic acid	157	1789	Nicotine hydrochloride, solid	151	3444
Musk xylene	149	2956	Nicotine hydrochloride, solution	151	1656
Mustard	153	—	Nicotine preparation, liquid, n.o.s.	151	3144
Mustard Lewisite	153	—	Nicotine preparation, solid, n.o.s.	151	1655
Naphthalene, crude	133	1334	Nicotine salicylate	151	1657
Naphthalene, molten	133	2304	Nicotine sulfate, solid	151	3445
Naphthalene, refined	133	1334	Nicotine sulfate, solution	151	1658
Naphthylamine (alpha)	153	2077	Nicotine sulphate, solid	151	3445
Naphthylamine (beta), solid	153	1650	Nicotine sulphate, solution	151	1658
Naphthylamine (beta), solution	153	3411	Nicotine tartrate	151	1659
Naphthylthiourea	153	1651	Nitrates, inorganic, aqueous solution, n.o.s.	140	3218
Naphthylurea	153	1652	Nitrates, inorganic, n.o.s.	140	1477
Natural gas, compressed	115	1971			

Name of Material	Guide No.	ID No.	Name of Material	Guide No.	ID No.
Nitrating acid mixture with more than 50% nitric acid	157	1796	Nitriles, toxic, flammable, n.o.s.	131	3275
Nitrating acid mixture with not more than 50% nitric acid	157	1796	Nitriles, toxic, liquid, n.o.s.	151	3276
Nitrating acid mixture, spent, with more than 50% nitric acid	157	1826	Nitriles, toxic, solid, n.o.s.	151	3439
Nitrating acid mixture, spent, with not more than 50% nitric acid	157	1826	Nitrites, inorganic, aqueous solution, n.o.s.	140	3219
Nitric acid, other than red fuming, with more than 65% nitric acid	157	2031	Nitrites, inorganic, n.o.s.	140	2627
Nitric acid, other than red fuming, with not more than 65% nitric acid	157	2031	Nitroanilines	153	1661
Nitric acid, red fuming	157	2032	Nitroanisoles, liquid	152	2730
Nitric oxide	124	1660	Nitroanisoles, solid	152	3458
Nitric oxide, compressed	124	1660	Nitrobenzene	152	1662
Nitric oxide and Dinitrogen tetroxide mixture	124	1975	Nitrobenzenesulfonic acid	153	2305
Nitric oxide and Nitrogen dioxide mixture	124	1975	Nitrobenzenesulphonic acid	153	2305
Nitriles, flammable, poisonous, n.o.s.	131	3273	Nitrobenzotrifluorides, liquid	152	2306
Nitriles, flammable, toxic, n.o.s.	131	3273	Nitrobenzotrifluorides, solid	152	3431
Nitriles, liquid, poisonous, n.o.s.	151	3276	Nitrobromobenzenes, liquid	152	2732
Nitriles, liquid, toxic, n.o.s.	151	3276	Nitrobromobenzenes, solid	152	3459
Nitriles, poisonous, flammable, n.o.s.	131	3275	Nitrocellulose membrane filters	133	3270
Nitriles, poisonous, liquid, n.o.s.	151	3276	Nitrocellulose mixture, without pigment	133	2557
Nitriles, poisonous, solid, n.o.s.	151	3439	Nitrocellulose mixture, without plasticizer	133	2557
Nitriles, solid, poisonous, n.o.s.	151	3439	Nitrocellulose mixture, with pigment	133	2557
Nitriles, solid, toxic, n.o.s.	151	3439	Nitrocellulose mixture, with plasticizer	133	2557
			Nitrocellulose, solution, flammable	127	2059
			Nitrocellulose with alcohol, not less than 25% alcohol	113	2556
			Nitrocellulose with water, not less than 25% water	113	2555
			3-Nitro-4-chlorobenzotrifluoride	152	2307
			Nitrocresols, liquid	153	3434
			Nitrocresols, solid	153	2446

Name of Material **Guide ID**
No. **No.**

Name of Material **Guide ID**
No. **No.**

Nitroethane	129	2842
Nitrogen	120	1066
Nitrogen, compressed	120	1066
Nitrogen, refrigerated liquid (cryogenic liquid)	120	1977
Nitrogen dioxide	124	1067
Nitrogen dioxide and Nitric oxide mixture	124	1975
Nitrogen trifluoride	122	2451
Nitrogen trifluoride, compressed	122	2451
Nitrogen trioxide	124	2421
Nitroglycerin, solution in alcohol, with more than 1% but not more than 5% Nitroglycerin	127	3064
Nitroglycerin, solution in alcohol, with not more than 1% Nitroglycerin	127	1204
Nitroglycerin mixture, desensitized, liquid, flammable, n.o.s., with not more than 30% Nitroglycerin	113	3343
Nitroglycerin mixture, desensitized, liquid, n.o.s., with not more than 30% Nitroglycerin	113	3357
Nitroglycerin mixture, desensitized, solid, n.o.s., with more than 2% but not more than 10% Nitroglycerin	113	3319
Nitroguanidine, wetted with not less than 20% water	113	1336
Nitrohydrochloric acid	157	1798
Nitromethane	129	1261
Nitronaphthalene	133	2538
Nitrophenols	153	1663
4-Nitrophenylhydrazine, with not less than 30% water	113	3376

Nitropropanes	129	2608
p-Nitrosodimethylaniline	135	1369
Nitrostarch, wetted with not less than 20% water	113	1337
Nitrosyl chloride	125	1069
Nitrosylsulfuric acid, liquid	157	2308
Nitrosylsulfuric acid, solid	157	3456
Nitrosylsulphuric acid, liquid	157	2308
Nitrosylsulphuric acid, solid	157	3456
Nitrotoluenes, liquid	152	1664
Nitrotoluenes, solid	152	3446
Nitrotoluidines (mono)	153	2660
Nitrous oxide	122	1070
Nitrous oxide, compressed	122	1070
Nitrous oxide, refrigerated liquid	122	2201
Nitrous oxide and Carbon dioxide mixture	126	1015
Nitroxylenes, liquid	152	1665
Nitroxylenes, solid	152	3447
Nonanes	128	1920
Nonyltrichlorosilane	156	1799
2,5-Norbornadiene, stabilized	128P	2251
Octadecyltrichlorosilane	156	1800
Octadiene	128P	2309
Octafluorobut-2-ene	126	2422
Octafluorocyclobutane	126	1976
Octafluoropropane	126	2424
Octanes	128	1262
Octyl aldehydes	129	1191
Octyltrichlorosilane	156	1801
Oil, petroleum	128	1270
Oil gas	119	1071

Name of Material	Guide No.	ID No.	Name of Material	Guide No.	ID No.
Oil gas, compressed	119	1071	Organic phosphate mixed with compressed gas	123	1955
Organic peroxide type B, liquid	146	3101	Organic phosphorus compound mixed with compressed gas	123	1955
Organic peroxide type B, liquid, temperature controlled	148	3111	Organic pigments, self-heating	135	3313
Organic peroxide type B, solid	146	3102	Organoarsenic compound, liquid, n.o.s.	151	3280
Organic peroxide type B, solid, temperature controlled	148	3112	Organoarsenic compound, solid, n.o.s.	151	3465
Organic peroxide type C, liquid	146	3103	Organochlorine pesticide, liquid, flammable, poisonous	131	2762
Organic peroxide type C, liquid, temperature controlled	148	3113	Organochlorine pesticide, liquid, flammable, toxic	131	2762
Organic peroxide type C, solid	146	3104	Organochlorine pesticide, liquid, poisonous	151	2996
Organic peroxide type C, solid, temperature controlled	148	3114	Organochlorine pesticide, liquid, poisonous, flammable	131	2995
Organic peroxide type D, liquid	145	3105	Organochlorine pesticide, liquid, toxic	151	2996
Organic peroxide type D, liquid, temperature controlled	148	3115	Organochlorine pesticide, liquid, toxic, flammable	131	2995
Organic peroxide type D, solid	145	3106	Organochlorine pesticide, solid, poisonous	151	2761
Organic peroxide type D, solid, temperature controlled	148	3116	Organochlorine pesticide, solid, toxic	151	2761
Organic peroxide type E, liquid	145	3107	Organometallic compound, liquid, poisonous, n.o.s.	151	3282
Organic peroxide type E, liquid, temperature controlled	148	3117	Organometallic compound, liquid, toxic, n.o.s.	151	3282
Organic peroxide type E, solid	145	3108	Organometallic compound, poisonous, liquid, n.o.s.	151	3282
Organic peroxide type E, solid, temperature controlled	148	3118	Organometallic compound, poisonous, solid, n.o.s.	151	3467
Organic peroxide type F, liquid	145	3109	Organometallic compound, solid, poisonous, n.o.s.	151	3467
Organic peroxide type F, liquid, temperature controlled	148	3119	Organometallic compound, solid, toxic, n.o.s.	151	3467
Organic peroxide type F, solid	145	3110	Organometallic compound, toxic, liquid, n.o.s.	151	3282
Organic peroxide type F, solid, temperature controlled	148	3120			
Organic phosphate compound mixed with compressed gas	123	1955			

Name of Material	Guide No.	ID No.	Name of Material	Guide No.	ID No.
Organometallic compound, toxic, solid, n.o.s.	151	3467	Organophosphorus compound, toxic, flammable, n.o.s.	131	3279
Organometallic substance, liquid, pyrophoric	135	3392	Organophosphorus compound, toxic, liquid, n.o.s.	151	3278
Organometallic substance, liquid, pyrophoric, water-reactive	135	3394	Organophosphorus compound, toxic, solid, n.o.s.	151	3464
Organometallic substance, liquid, water-reactive	135	3398	Organophosphorus pesticide, liquid, flammable, poisonous	131	2784
Organometallic substance, liquid, water-reactive, flammable	138	3399	Organophosphorus pesticide, liquid, flammable, toxic	131	2784
Organometallic substance, solid, pyrophoric	135	3391	Organophosphorus pesticide, liquid, poisonous	152	3018
Organometallic substance, solid, pyrophoric, water-reactive	135	3393	Organophosphorus pesticide, liquid, poisonous, flammable	131	3017
Organometallic substance, solid, self-heating	138	3400	Organophosphorus pesticide, liquid, toxic	152	3018
Organometallic substance, solid, water-reactive	135	3395	Organophosphorus pesticide, liquid, toxic, flammable	131	3017
Organometallic substance, solid, water-reactive, flammable	138	3396	Organophosphorus pesticide, solid, poisonous	152	2783
Organometallic substance, solid, water-reactive, self-heating	138	3397	Organophosphorus pesticide, solid, toxic	152	2783
Organophosphorus compound, liquid, poisonous, n.o.s.	151	3278	Organotin compound, liquid, n.o.s.	153	2788
Organophosphorus compound, liquid, toxic, n.o.s.	151	3278	Organotin compound, solid, n.o.s.	153	3146
Organophosphorus compound, poisonous, flammable, n.o.s.	131	3279	Organotin pesticide, liquid, flammable, poisonous	131	2787
Organophosphorus compound, poisonous, liquid, n.o.s.	151	3278	Organotin pesticide, liquid, flammable, toxic	131	2787
Organophosphorus compound, poisonous, solid, n.o.s.	151	3464	Organotin pesticide, liquid, poisonous	153	3020
Organophosphorus compound, solid, poisonous, n.o.s.	151	3464	Organotin pesticide, liquid, poisonous, flammable	131	3019
Organophosphorus compound, solid, toxic, n.o.s.	151	3464	Organotin pesticide, liquid, toxic	153	3020
			Organotin pesticide, liquid, toxic, flammable	131	3019
			Organotin pesticide, solid, poisonous	153	2786

Name of Material	Guide No.	ID No.	Name of Material	Guide No.	ID No.
Organotin pesticide, solid, toxic	153	2786	Packagings discarded, empty, uncleaned	171	3509
Osmium tetroxide	154	2471	Paint (corrosive)	153	3066
Other regulated substances, liquid, n.o.s.	171	3082	Paint, corrosive, flammable	132	3470
Other regulated substances, solid, n.o.s.	171	3077	Paint (flammable)	128	1263
Oxidizing liquid, corrosive, n.o.s.	140	3098	Paint, flammable, corrosive	132	3469
Oxidizing liquid, n.o.s.	140	3139	Paint related material (corrosive)	153	3066
Oxidizing liquid, poisonous, n.o.s.	142	3099	Paint related material, corrosive, flammable	132	3470
Oxidizing liquid, toxic, n.o.s.	142	3099	Paint related material (flammable)	128	1263
Oxidizing solid, corrosive, n.o.s.	140	3085	Paint related material, flammable, corrosive	132	3469
Oxidizing solid, flammable, n.o.s.	140	3137	Paper, unsaturated oil treated	133	1379
Oxidizing solid, n.o.s.	140	1479	Paraformaldehyde	133	2213
Oxidizing solid, poisonous, n.o.s.	141	3087	Paraldehyde	129	1264
Oxidizing solid, self-heating, n.o.s.	135	3100	Parathion and compressed gas mixture	123	1967
Oxidizing solid, toxic, n.o.s.	141	3087	PCB	171	2315
Oxidizing solid, water-reactive, n.o.s.	144	3121	PD	152	---
Oxygen	122	1072	Pentaborane	135	1380
Oxygen, compressed	122	1072	Pentachloroethane	151	1669
Oxygen, refrigerated liquid (cryogenic liquid)	122	1073	Pentachlorophenol	154	3155
Oxygen and Carbon dioxide mixture, compressed	122	1014	Pentaerythrite tetranitrate mixture, desensitized, solid, n.o.s., with more than 10% but not more than 20% PETN	113	3344
Oxygen difluoride	124	2190	Pentaerythritol tetranitrate mixture, desensitized, solid, n.o.s., with more than 10% but not more than 20% PETN	113	3344
Oxygen difluoride, compressed	124	2190	Pentafluoroethane	126	3220
Oxygen generator, chemical	140	3356	Pentafluoroethane and Ethylene oxide mixture, with not more than 7.9% Ethylene oxide	126	3298
Oxygen generator, chemical, spent	140	3356	Pentamethylheptane	128	2286

Name of Material	Guide No.	ID No.	Name of Material	Guide No.	ID No.
Pentane-2,4-dione	131	2310	Pesticide, liquid, flammable, poisonous, n.o.s.	131	3021
Pentanes	128	1265	Pesticide, liquid, flammable, toxic, n.o.s.	131	3021
Pentanol	129	1105	Pesticide, liquid, poisonous, flammable, n.o.s.	131	2903
1-Pentene	128	1108	Pesticide, liquid, poisonous, n.o.s.	151	2902
1-Pentol	153P	2705	Pesticide, liquid, toxic, flammable, n.o.s.	131	2903
Perchlorates, inorganic, aqueous solution, n.o.s.	140	3211	Pesticide, liquid, toxic, n.o.s.	151	2902
Perchlorates, inorganic, n.o.s.	140	1481	Pesticide, solid, poisonous, n.o.s.	151	2588
Perchloric acid, with more than 50% but not more than 72% acid	143	1873	Pesticide, solid, toxic, n.o.s.	151	2588
Perchloric acid, with not more than 50% acid	157	1802	PETN mixture, desensitized, solid, n.o.s., with more than 10% but not more than 20% PETN	113	3344
Perchloroethylene	160	1897	Petrol	128	1203
Perchloromethyl mercaptan	157	1670	Petrol and ethanol mixture, with more than 10% ethanol	127	3475
Perchloryl fluoride	124	3083	Petroleum crude oil	128	1267
Perfluoro(ethyl vinyl ether)	115	3154	Petroleum distillates, n.o.s.	128	1268
Perfluoro(methyl vinyl ether)	115	3153	Petroleum gases, liquefied	115	1075
Perfumery products, with flammable solvents	127	1266	Petroleum oil	128	1270
Permanganates, inorganic, aqueous solution, n.o.s.	140	3214	Petroleum products, n.o.s.	128	1268
Permanganates, inorganic, n.o.s.	140	1482	Petroleum sour crude oil, flammable, poisonous	131	3494
Peroxides, inorganic, n.o.s.	140	1483	Petroleum sour crude oil, flammable, toxic	131	3494
Peroxyacetic acid and hydrogen peroxide mixture, with acid(s), water and not more than 5% Peroxyacetic acid, stabilized	140	3149	Phenacyl bromide	153	2645
Persulfates, inorganic, aqueous solution, n.o.s.	140	3216	Phenetidines	153	2311
Persulfates, inorganic, n.o.s.	140	3215	Phenol, molten	153	2312
Persulphates, inorganic, aqueous solution, n.o.s.	140	3216	Phenol, solid	153	1671
Persulphates, inorganic, n.o.s.	140	3215	Phenol solution	153	2821
			Phenolates, liquid	154	2904
			Phenolates, solid	154	2905

Name of Material	Guide No.	ID No.	Name of Material	Guide No.	ID No.
Phenolsulfonic acid, liquid	153	1803	Phenylphosphorus thiodichloride	137	2799
Phenolsulphonic acid, liquid	153	1803	Phenyltrichlorosilane	156	1804
Phenoxyacetic acid derivative pesticide, liquid, flammable, poisonous	131	3346	Phenyl urea pesticide, liquid, poisonous	151	3002
Phenoxyacetic acid derivative pesticide, liquid, flammable, toxic	131	3346	Phenyl urea pesticide, liquid, toxic	151	3002
Phenoxyacetic acid derivative pesticide, liquid, poisonous	153	3348	Phosgene	125	1076
Phenoxyacetic acid derivative pesticide, liquid, poisonous, flammable	131	3347	9-Phosphabicyclononanes	135	2940
Phenoxyacetic acid derivative pesticide, liquid, toxic	153	3348	Phosphine	119	2199
Phenoxyacetic acid derivative pesticide, liquid, toxic, flammable	131	3347	Phosphine, adsorbed	173	3525
Phenoxyacetic acid derivative pesticide, solid, poisonous	153	3345	Phosphoric acid, solid	154	3453
Phenoxyacetic acid derivative pesticide, solid, toxic	153	3345	Phosphoric acid, solution	154	1805
Phenylacetonitrile, liquid	152	2470	Phosphorous acid	154	2834
Phenylacetyl chloride	156	2577	Phosphorus, amorphous	133	1338
Phenylcarbylamine chloride	151	1672	Phosphorus, white, dry or under water or in solution	136	1381
Phenyl chloroformate	156	2746	Phosphorus, white, molten	136	2447
Phenylenediamines	153	1673	Phosphorus, yellow, dry or under water or in solution	136	1381
Phenylhydrazine	153	2572	Phosphorus heptasulfide, free from yellow and white Phosphorus	139	1339
Phenyl isocyanate	155	2487	Phosphorus heptasulphide, free from yellow and white Phosphorus	139	1339
Phenyl mercaptan	131	2337	Phosphorus oxybromide, molten	137	2576
Phenylmercuric acetate	151	1674	Phosphorus oxybromide, solid	137	1939
Phenylmercuric compound, n.o.s.	151	2026	Phosphorus oxychloride	137	1810
Phenylmercuric hydroxide	151	1894	Phosphorus pentabromide	137	2691
Phenylmercuric nitrate	151	1895	Phosphorus pentachloride	137	1806
Phenylphosphorus dichloride	137	2798	Phosphorus pentafluoride	125	2198
			Phosphorus pentafluoride, adsorbed	173	3524
			Phosphorus pentafluoride, compressed	125	2198

Name of Material **Guide ID**
No. **No.**

Name of Material **Guide ID**
No. **No.**

Phosphorus pentasulfide, free from yellow and white Phosphorus **139** 1340

Phosphorus pentasulphide, free from yellow and white Phosphorus **139** 1340

Phosphorus pentoxide **137** 1807

Phosphorus sesquisulfide, free from yellow and white Phosphorus **139** 1341

Phosphorus sesquisulphide, free from yellow and white Phosphorus **139** 1341

Phosphorus tribromide **137** 1808

Phosphorus trichloride **137** 1809

Phosphorus trioxide **157** 2578

Phosphorus trisulfide, free from yellow and white Phosphorus **139** 1343

Phosphorus trisulphide, free from yellow and white Phosphorus **139** 1343

Phthalic anhydride **156** 2214

Picolines **129** 2313

Picric acid, wetted with not less than 10% water **113** 3364

Picric acid, wetted with not less than 30% water **113** 1344

Picrite, wetted with not less than 20% water **113** 1336

Picryl chloride, wetted with not less than 10% water **113** 3365

Pinene (alpha) **128** 2368

Pine oil **129** 1272

Piperazine **153** 2579

Piperidine **132** 2401

Plastic molding compound **171** 3314

Plastics moulding compound **171** 3314

Plastics, nitrocellulose-based, self-heating, n.o.s. **135** 2006

Poisonous by inhalation liquid, corrosive, flammable, n.o.s. (Inhalation Hazard Zone A) **131** 3492

Poisonous by inhalation liquid, corrosive, flammable, n.o.s. (Inhalation Hazard Zone B) **131** 3493

Poisonous by inhalation liquid, corrosive, n.o.s. (Inhalation Hazard Zone A) **154** 3389

Poisonous by inhalation liquid, corrosive, n.o.s. (Inhalation Hazard Zone B) **154** 3390

Poisonous by inhalation liquid, flammable, corrosive, n.o.s. (Inhalation Hazard Zone A) **131** 3488

Poisonous by inhalation liquid, flammable, corrosive, n.o.s. (Inhalation Hazard Zone B) **131** 3489

Poisonous by inhalation liquid, flammable, n.o.s. (Inhalation Hazard Zone A) **131** 3383

Poisonous by inhalation liquid, flammable, n.o.s. (Inhalation Hazard Zone B) **131** 3384

Poisonous by inhalation liquid, n.o.s. (Inhalation Hazard Zone A) **151** 3381

Poisonous by inhalation liquid, n.o.s. (Inhalation Hazard Zone B) **151** 3382

Poisonous by inhalation liquid, oxidizing, n.o.s. (Inhalation Hazard Zone A) **142** 3387

Poisonous by inhalation liquid, oxidizing, n.o.s. (Inhalation Hazard Zone B) **142** 3388

Poisonous by inhalation liquid, water-reactive, flammable, n.o.s. (Inhalation Hazard Zone A) **155** 3490

Name of Material **Guide ID**
No. **No.**

Name of Material **Guide ID**
No. **No.**

Poisonous by inhalation liquid, water-reactive, flammable, n.o.s. (Inhalation Hazard Zone B) **155** 3491

Poisonous by inhalation liquid, water-reactive, n.o.s. (Inhalation Hazard Zone A) **139** 3385

Poisonous by inhalation liquid, water-reactive, n.o.s. (Inhalation Hazard Zone B) **139** 3386

Poisonous liquid, corrosive, inorganic, n.o.s. **154** 3289

Poisonous liquid, corrosive, organic, n.o.s. **154** 2927

Poisonous liquid, flammable, organic, n.o.s. **131** 2929

Poisonous liquid, inorganic, n.o.s. **151** 3287

Poisonous liquid, organic, n.o.s. **153** 2810

Poisonous liquid, oxidizing, n.o.s. **142** 3122

Poisonous liquid, water-reactive, n.o.s. **139** 3123

Poisonous solid, corrosive, inorganic, n.o.s. **154** 3290

Poisonous solid, corrosive, organic, n.o.s. **154** 2928

Poisonous solid, flammable, organic, n.o.s. **134** 2930

Poisonous solid, inorganic, n.o.s. **151** 3288

Poisonous solid, organic, n.o.s. **154** 2811

Poisonous solid, oxidizing, n.o.s. **141** 3086

Poisonous solid, self-heating, n.o.s. **136** 3124

Poisonous solid, water-reactive, n.o.s. **139** 3125

Polyamines, flammable, corrosive, n.o.s. **132** 2733

Polyamines, liquid, corrosive, flammable, n.o.s. **132** 2734

Polyamines, liquid, corrosive, n.o.s. **153** 2735

Polyamines, solid, corrosive, n.o.s. **154** 3259

Polychlorinated biphenyls, liquid **171** 2315

Polychlorinated biphenyls, solid **171** 3432

Polyester resin kit, liquid base material **128** 3269

Polyester resin kit, solid base material **128P** 3527

Polyhalogenated biphenyls, liquid **171** 3151

Polyhalogenated biphenyls, solid **171** 3152

Polyhalogenated terphenyls, liquid **171** 3151

Polyhalogenated terphenyls, solid **171** 3152

Polymeric beads, expandable **171** 2211

Polymerizing substance, liquid, stabilized, n.o.s. **149P** 3532

Polymerizing substance, liquid, temperature controlled, n.o.s. **150P** 3534

Polymerizing substance, solid, stabilized, n.o.s. **149P** 3531

Polymerizing substance, solid, temperature controlled, n.o.s. **150P** 3533

Potassium **138** 2257

Potassium, metal alloys, liquid **138** 1420

Potassium, metal alloys, solid **138** 3403

Potassium arsenate **151** 1677

Potassium arsenite **154** 1678

Potassium borohydride **138** 1870

Name of Material	Guide No.	ID No.	Name of Material	Guide No.	ID No.
Potassium bromate	140	1484	Potassium persulphate	140	1492
Potassium chlorate	140	1485	Potassium phosphide	139	2012
Potassium chlorate, aqueous solution	140	2427	Potassium sodium alloys, liquid	138	1422
Potassium cuprocyanide	157	1679	Potassium sodium alloys, solid	138	3404
Potassium cyanide, solid	157	1680	Potassium sulfide, anhydrous	135	1382
Potassium cyanide, solution	157	3413	Potassium sulfide, hydrated, with not less than 30% water of crystallization	153	1847
Potassium dithionite	135	1929	Potassium sulfide, with less than 30% water of crystallization	135	1382
Potassium fluoride, solid	154	1812	Potassium sulphide, anhydrous	135	1382
Potassium fluoride, solution	154	3422	Potassium sulphide, hydrated, with not less than 30% water of crystallization	153	1847
Potassium fluoroacetate	151	2628	Potassium sulphide, with less than 30% water of crystallization	135	1382
Potassium fluorosilicate	151	2655	Potassium superoxide	143	2466
Potassium hydrogen difluoride, solid	154	1811	Printing ink, flammable	129	1210
Potassium hydrogen difluoride, solution	154	3421	Printing ink related material, flammable	129	1210
Potassium hydrogen sulfate	154	2509	Propadiene, stabilized	116P	2200
Potassium hydrogen sulphate	154	2509	Propadiene and Methylacetylene mixture, stabilized	116P	1060
Potassium hydrosulfite	135	1929	Propane	115	1075
Potassium hydrosulphite	135	1929	Propane	115	1978
Potassium hydroxide, solid	154	1813	Propane-Ethane mixture, refrigerated liquid	115	1961
Potassium hydroxide, solution	154	1814	Propanethiols	130	2402
Potassium metavanadate	151	2864	n-Propanol	129	1274
Potassium monoxide	154	2033	Propionaldehyde	129P	1275
Potassium nitrate	140	1486	Propionic acid	153	1848
Potassium nitrate and Sodium nitrate mixture	140	1499	Propionic acid, with not less than 10% and less than 90% acid	153	1848
Potassium nitrate and Sodium nitrite mixture	140	1487			
Potassium nitrite	140	1488			
Potassium perchlorate	140	1489			
Potassium permanganate	140	1490			
Potassium peroxide	144	1491			
Potassium persulfate	140	1492			

Name of Material	Guide No.	ID No.	Name of Material	Guide No.	ID No.
Propionic acid, with not less than 90% acid	153	3463	Pyrethroid pesticide, liquid, poisonous	151	3352
Propionic anhydride	156	2496	Pyrethroid pesticide, liquid, poisonous, flammable	131	3351
Propionitrile	131	2404	Pyrethroid pesticide, liquid, toxic	151	3352
Propionyl chloride	132	1815	Pyrethroid pesticide, liquid, toxic, flammable	131	3351
n-Propyl acetate	129	1276	Pyrethroid pesticide, solid, poisonous	151	3349
Propyl alcohol, normal	129	1274	Pyrethroid pesticide, solid, toxic	151	3349
Propylamine	132	1277	Pyridine	129	1282
n-Propyl benzene	128	2364	Pyrophoric alloy, n.o.s.	135	1383
Propyl chloride	129	1278	Pyrophoric liquid, inorganic, n.o.s.	135	3194
n-Propyl chloroformate	155	2740	Pyrophoric liquid, organic, n.o.s.	135	2845
Propylene	115	1075	Pyrophoric metal, n.o.s.	135	1383
Propylene	115	1077	Pyrophoric solid, inorganic, n.o.s.	135	3200
Propylene, Ethylene and Acetylene in mixture, refrigerated liquid containing at least 71.5% Ethylene with not more than 22.5% Acetylene and not more than 6% Propylene	115	3138	Pyrophoric solid, organic, n.o.s.	135	2846
Propylene chlorohydrin	131	2611	Pyrosulfuryl chloride	137	1817
1,2-Propylenediamine	132	2258	Pyrosulphuryl chloride	137	1817
Propyleneimine, stabilized	131P	1921	Pyrrolidine	132	1922
Propylene oxide	127P	1280	Quinoline	154	2656
Propylene oxide and Ethylene oxide mixture, with not more than 30% Ethylene oxide	131P	2983	Radioactive material, excepted package, articles	161	2911
Propylene tetramer	128	2850	Radioactive material, excepted package, articles manufactured from depleted Uranium	161	2909
Propyl formates	129	1281	Radioactive material, excepted package, articles manufactured from natural Thorium	161	2909
n-Propyl isocyanate	155P	2482			
n-Propyl nitrate	128	1865			
Propyltrichlorosilane	155	1816			
Pyrethroid pesticide, liquid, flammable, poisonous	131	3350			
Pyrethroid pesticide, liquid, flammable, toxic	131	3350			

Name of Material	Guide No.	ID No.	Name of Material	Guide No.	ID No.
Radioactive material, excepted package, articles manufactured from natural Uranium	161	2909	Radioactive material, transported under special arrangement, non fissile or fissile-excepted	163	2919
Radioactive material, excepted package, empty packaging	161	2908	Radioactive material, Type A package, fissile, non-special form	165	3327
Radioactive material, excepted package, instruments	161	2911	Radioactive material, Type A package, non-special form, non fissile or fissile-excepted	163	2915
Radioactive material, excepted package, limited quantity of material	161	2910	Radioactive material, Type A package, special form, fissile	165	3333
Radioactive material, low specific activity (LSA-I), non fissile or fissile-excepted	162	2912	Radioactive material, Type A package, special form, non fissile or fissile-excepted	164	3332
Radioactive material, low specific activity (LSA-II), fissile	165	3324	Radioactive material, Type B(M) package, fissile	165	3329
Radioactive material, low specific activity (LSA-II), non fissile or fissile-excepted	162	3321	Radioactive material, Type B(M) package, non fissile or fissile-excepted	163	2917
Radioactive material, low specific activity (LSA-III), fissile	165	3325	Radioactive material, Type B(U) package, fissile	165	3328
Radioactive material, low specific activity (LSA-III), non fissile or fissile-excepted	162	3322	Radioactive material, Type B(U) package, non fissile or fissile-excepted	163	2916
Radioactive material, surface contaminated objects (SCO-I), fissile	165	3326	Radioactive material, Type C package, fissile	165	3330
Radioactive material, surface contaminated objects (SCO-I), non fissile or fissile-excepted	162	2913	Radioactive material, Type C package, non fissile or fissile excepted	163	3323
Radioactive material, surface contaminated objects (SCO-II), fissile	165	3326	Radioactive material, Uranium hexafluoride, fissile	166	2977
Radioactive material, surface contaminated objects (SCO-II), non fissile or fissile-excepted	162	2913	Radioactive material, Uranium hexafluoride, non fissile or fissile-excepted	166	2978
Radioactive material, transported under special arrangement, fissile	165	3331	Rags, oily	133	1856

Name of Material	Guide No.	ID No.	Name of Material	Guide No.	ID No.
Receptacles, small, containing gas	115	2037	Refrigerant gas R-218	126	2424
Red phosphorus	133	1338	Refrigerant gas R-227	126	3296
Refrigerant gas, n.o.s.	126	1078	Refrigerant gas R-404A	126	3337
Refrigerant gases, n.o.s. (flammable)	115	1954	Refrigerant gas R-407A	126	3338
Refrigerant gas R-12	126	1028	Refrigerant gas R-407B	126	3339
Refrigerant gas R-12B1	126	1974	Refrigerant gas R-407C	126	3340
Refrigerant gas R-12B2	171	1941	Refrigerant gas R-500	126	2602
Refrigerant gas R-13	126	1022	Refrigerant gas R-502	126	1973
Refrigerant gas R-13B1	126	1009	Refrigerant gas R-503	126	2599
Refrigerant gas R-14	126	1982	Refrigerant gas R-1113	119P	1082
Refrigerant gas R-14, compressed	126	1982	Refrigerant gas R-1132a	116P	1959
Refrigerant gas R-21	126	1029	Refrigerant gas R-1216	126	1858
Refrigerant gas R-22	126	1018	Refrigerant gas R-1318	126	2422
Refrigerant gas R-23	126	1984	Refrigerant gas RC-318	126	1976
Refrigerant gas R-32	115	3252	Refrigerating machines, containing Ammonia solutions (UN2672)	126	2857
Refrigerant gas R-40	115	1063	Refrigerating machines, containing flammable, non-poisonous, liquefied gas	115	3358
Refrigerant gas R-41	115	2454	Refrigerating machines, containing flammable, non-toxic, liquefied gas	115	3358
Refrigerant gas R-114	126	1958	Refrigerating machines, containing non-flammable, non-poisonous gases	126	2857
Refrigerant gas R-115	126	1020	Refrigerating machines, containing non-flammable, non-toxic gases	126	2857
Refrigerant gas R-116	126	2193	Regulated medical waste, n.o.s.	158	3291
Refrigerant gas R-116, compressed	126	2193	Resin solution	127	1866
Refrigerant gas R-124	126	1021	Resorcinol	153	2876
Refrigerant gas R-125	126	3220	Rosin oil	127	1286
Refrigerant gas R-133a	126	1983	Rubber scrap, powdered or granulated	133	1345
Refrigerant gas R-134a	126	3159			
Refrigerant gas R-142b	115	2517			
Refrigerant gas R-143a	115	2035			
Refrigerant gas R-152a	115	1030			
Refrigerant gas R-161	115	2453			

Name of Material	Guide No.	ID No.	Name of Material	Guide No.	ID No.
Rubber shoddy, powdered or granulated	133	1345	Self-heating liquid, poisonous, inorganic, n.o.s.	136	3187
Rubber solution	127	1287	Self-heating liquid, poisonous, organic, n.o.s.	136	3184
Rubidium	138	1423	Self-heating liquid, toxic, inorganic, n.o.s.	136	3187
Rubidium hydroxide, solid	154	2678	Self-heating liquid, toxic, organic, n.o.s.	136	3184
Rubidium hydroxide, solution	154	2677	Self-heating solid, corrosive, inorganic, n.o.s.	136	3192
SA	119	---	Self-heating solid, corrosive, organic, n.o.s.	136	3126
Safety devices	171	3268	Self-heating solid, inorganic, n.o.s.	135	3190
Sarin	153	---	Self-heating solid, organic, n.o.s.	135	3088
Seat-belt pre-tensioners	171	3268	Self-heating solid, oxidizing, n.o.s.	135	3127
Seed cake, with more than 1.5% oil and not more than 11% moisture	135	1386	Self-heating solid, poisonous, inorganic, n.o.s.	136	3191
Seed cake, with not more than 1.5% oil and not more than 11% moisture	135	2217	Self-heating solid, poisonous, organic, n.o.s.	136	3128
Selenates	151	2630	Self-heating solid, toxic, inorganic, n.o.s.	136	3191
Selenic acid	154	1905	Self-heating solid, toxic, organic, n.o.s.	136	3128
Selenites	151	2630	Self-heating solid, toxic, inorganic, n.o.s.	136	3191
Selenium compound, liquid, n.o.s.	151	3440	Self-heating solid, toxic, organic, n.o.s.	136	3128
Selenium compound, solid, n.o.s.	151	3283	Self-reactive liquid type B	149	3221
Selenium disulfide	153	2657	Self-reactive liquid type B, temperature controlled	150	3231
Selenium disulphide	153	2657	Self-reactive liquid type C	149	3223
Selenium hexafluoride	125	2194	Self-reactive liquid type C, temperature controlled	150	3233
Selenium oxychloride	157	2879	Self-reactive liquid type D	149	3225
Self-defense spray, non-pressurized	171	3334	Self-reactive liquid type D, temperature controlled	150	3235
Self-heating liquid, corrosive, inorganic, n.o.s.	136	3188	Self-reactive liquid type E	149	3227
Self-heating liquid, corrosive, organic, n.o.s.	136	3185	Self-reactive liquid type E, temperature controlled	150	3237
Self-heating liquid, inorganic, n.o.s.	135	3186	Self-reactive liquid type F	149	3229
Self-heating liquid, organic, n.o.s.	135	3183			

Name of Material	Guide No.	ID No.	Name of Material	Guide No.	ID No.
Self-reactive liquid type F, temperature controlled	150	3239	Sodium	138	1428
Self-reactive solid type B	149	3222	Sodium aluminate, solid	154	2812
Self-reactive solid type B, temperature controlled	150	3232	Sodium aluminate, solution	154	1819
Self-reactive solid type C	149	3224	Sodium aluminum hydride	138	2835
Self-reactive solid type C, temperature controlled	150	3234	Sodium ammonium vanadate	154	2863
Self-reactive solid type D	149	3226	Sodium arsanilate	154	2473
Self-reactive solid type D, temperature controlled	150	3236	Sodium arsenate	151	1685
Self-reactive solid type E	149	3228	Sodium arsenite, aqueous solution	154	1686
Self-reactive solid type E, temperature controlled	150	3238	Sodium arsenite, solid	151	2027
Self-reactive solid type F	149	3230	Sodium azide	153	1687
Self-reactive solid type F, temperature controlled	150	3240	Sodium, batteries containing	138	3292
Shale oil	128	1288	Sodium bisulfate, solution	154	2837
Silane	116	2203	Sodium bisulphate, solution	154	2837
Silane, compressed	116	2203	Sodium borohydride	138	1426
Silicon powder, amorphous	170	1346	Sodium borohydride and Sodium hydroxide solution, with not more than 12% Sodium borohydride and not more than 40% Sodium hydroxide	157	3320
Silicon tetrachloride	157	1818	Sodium bromate	140	1494
Silicon tetrafluoride	125	1859	Sodium cacodylate	152	1688
Silicon tetrafluoride, adsorbed	173	3521	Sodium carbonate peroxyhydrate	140	3378
Silicon tetrafluoride, compressed	125	1859	Sodium chlorate	140	1495
Silver arsenite	151	1683	Sodium chlorate, aqueous solution	140	2428
Silver cyanide	151	1684	Sodium chlorite	143	1496
Silver nitrate	140	1493	Sodium chloroacetate	151	2659
Silver picrate, wetted with not less than 30% water	113	1347	Sodium cuprocyanide, solid	157	2316
Sludge acid	153	1906	Sodium cuprocyanide, solution	157	2317
Smokeless powder for small arms	133	3178	Sodium cyanide, solid	157	1689
Soda lime, with more than 4% Sodium hydroxide	154	1907	Sodium cyanide, solution	157	3414
			Sodium dichloroisocyanurate	140	2465

Name of Material	Guide No.	ID No.	Name of Material	Guide No.	ID No.
Sodium dichloro-s-triazinetrione	140	2465	Sodium methylate, solution in alcohol	132	1289
Sodium dinitro-o-cresolate, wetted with not less than 10% water	113	3369	Sodium monoxide	157	1825
Sodium dinitro-o-cresolate, wetted with not less than 15% water	113	1348	Sodium nitrate	140	1498
Sodium dithionite	135	1384	Sodium nitrate and Potassium nitrate mixture	140	1499
Sodium fluoride, solid	154	1690	Sodium nitrite	141	1500
Sodium fluoride, solution	154	3415	Sodium nitrite and Potassium nitrate mixture	140	1487
Sodium fluoroacetate	151	2629	Sodium pentachlorophenate	154	2567
Sodium fluorosilicate	154	2674	Sodium perborate monohydrate	140	3377
Sodium hydride	138	1427	Sodium perchlorate	140	1502
Sodium hydrogendifluoride	154	2439	Sodium permanganate	140	1503
Sodium hydrosulfide, hydrated, with not less than 25% water of crystallization	154	2949	Sodium peroxide	144	1504
Sodium hydrosulfide, with less than 25% water of crystallization	135	2318	Sodium peroxoborate, anhydrous	140	3247
Sodium hydrosulfide, with not less than 25% water of crystallization	154	2949	Sodium persulfate	140	1505
Sodium hydrosulfite	135	1384	Sodium persulphate	140	1505
Sodium hydrosulphide, hydrated, with not less than 25% water of crystallization	154	2949	Sodium phosphide	139	1432
Sodium hydrosulphide, with less than 25% water of crystallization	135	2318	Sodium picramate, wetted with not less than 20% water	113	1349
Sodium hydrosulphide, with not less than 25% water of crystallization	154	2949	Sodium potassium alloys, liquid	138	1422
Sodium hydrosulphite	135	1384	Sodium potassium alloys, solid	138	3404
Sodium hydroxide, solid	154	1823	Sodium sulfide, anhydrous	135	1385
Sodium hydroxide, solution	154	1824	Sodium sulfide, hydrated, with not less than 30% water	153	1849
Sodium hypochlorite	154	1791	Sodium sulfide, with less than 30% water of crystallization	135	1385
Sodium methylate, dry	138	1431	Sodium sulphide, anhydrous	135	1385
			Sodium sulphide, hydrated, with not less than 30% water	153	1849
			Sodium sulphide, with less than 30% water of crystallization	135	1385
			Sodium superoxide	143	2547

Name of Material	Guide No.	ID No.	Name of Material	Guide No.	ID No.
Solids containing corrosive liquid, n.o.s.	154	3244	Substituted nitrophenol pesticide, liquid, toxic, flammable	131	3013
Solids containing flammable liquid, n.o.s.	133	3175	Substituted nitrophenol pesticide, solid, poisonous	153	2779
Solids containing poisonous liquid, n.o.s.	151	3243	Substituted nitrophenol pesticide, solid, toxic	153	2779
Solids containing toxic liquid, n.o.s.	151	3243	Sulfamic acid	154	2967
Soman	153	---	Sulfur	133	1350
Stannic chloride, anhydrous	137	1827	Sulfur, molten	133	2448
Stannic chloride, pentahydrate	154	2440	Sulfur chlorides	137	1828
Stannic phosphides	139	1433	Sulfur dioxide	125	1079
Stibine	119	2676	Sulfur hexafluoride	126	1080
Straw, wet, damp or contaminated with oil	133	1327	Sulfuric acid	137	1830
Strontium arsenite	151	1691	Sulfuric acid, fuming	137	1831
Strontium chlorate	143	1506	Sulfuric acid, spent	137	1832
Strontium nitrate	140	1507	Sulfuric acid, with more than 51% acid	137	1830
Strontium perchlorate	140	1508	Sulfuric acid, with not more than 51% acid	157	2796
Strontium peroxide	143	1509	Sulfuric acid and Hydrofluoric acid mixture	157	1786
Strontium phosphide	139	2013	Sulfurous acid	154	1833
Strychnine	151	1692	Sulfur tetrafluoride	125	2418
Strychnine salts	151	1692	Sulfur trioxide, stabilized	137	1829
Styrene monomer, stabilized	128P	2055	Sulfuryl chloride	137	1834
Substituted nitrophenol pesticide, liquid, flammable, poisonous	131	2780	Sulfuryl fluoride	123	2191
Substituted nitrophenol pesticide, liquid, flammable, toxic	131	2780	Sulphamic acid	154	2967
Substituted nitrophenol pesticide, liquid, poisonous	153	3014	Sulphur	133	1350
Substituted nitrophenol pesticide, liquid, poisonous, flammable	131	3013	Sulphur, molten	133	2448
Substituted nitrophenol pesticide, liquid, toxic	153	3014	Sulphur chlorides	137	1828
			Sulphur dioxide	125	1079
			Sulphur hexafluoride	126	1080
			Sulphuric acid	137	1830
			Sulphuric acid, fuming	137	1831

Name of Material	Guide No.	ID No.	Name of Material	Guide No.	ID No.
Sulphuric acid, spent	137	1832	Tetrafluoroethylene, stabilized	116P	1081
Sulphuric acid, with more than 51% acid	137	1830	Tetrafluoromethane	126	1982
Sulphuric acid, with not more than 51% acid	157	2796	Tetrafluoromethane, compressed	126	1982
Sulphuric acid and Hydrofluoric acid mixture	157	1786	1,2,3,6-Tetrahydrobenzaldehyde	129	2498
Sulphurous acid	154	1833	Tetrahydrofuran	127	2056
Sulphur tetrafluoride	125	2418	Tetrahydrofurfurylamine	129	2943
Sulphur trioxide, stabilized	137	1829	Tetrahydrophthalic anhydrides	156	2698
Sulphuryl chloride	137	1834	1,2,3,6-Tetrahydropyridine	129	2410
Sulphuryl fluoride	123	2191	Tetrahydrothiophene	130	2412
Tabun	153	—	Tetramethylammonium hydroxide, solid	153	3423
Tars, liquid	130	1999	Tetramethylammonium hydroxide, solution	153	1835
Tear gas candles	159	1700	Tetramethylsilane	130	2749
Tear gas devices	159	1693	Tetranitromethane	143	1510
Tear gas grenades	159	1700	Tetrapropyl orthotitanate	128	2413
Tear gas substance, liquid, n.o.s.	159	1693	Textile waste, wet	133	1857
Tear gas substance, solid, n.o.s.	159	3448	Thallium chlorate	141	2573
Tellurium compound, n.o.s.	151	3284	Thallium compound, n.o.s.	151	1707
Tellurium hexafluoride	125	2195	Thallium nitrate	141	2727
Terpene hydrocarbons, n.o.s.	128	2319	4-Thiapentanal	152	2785
Terpinolene	128	2541	Thickened GD	153	—
Tetrabromoethane	159	2504	Thioacetic acid	129	2436
1,1,2,2-Tetrachloroethane	151	1702	Thiocarbamate pesticide, liquid, flammable, poisonous	131	2772
Tetrachloroethylene	160	1897	Thiocarbamate pesticide, liquid, flammable, toxic	131	2772
Tetraethyl dithiopyrophosphate	153	1704	Thiocarbamate pesticide, liquid, poisonous	151	3006
Tetraethylenepentamine	153	2320	Thiocarbamate pesticide, liquid, poisonous, flammable	131	3005
Tetraethyl silicate	129	1292	Thiocarbamate pesticide, liquid, toxic	151	3006
1,1,1,2-Tetrafluoroethane	126	3159			
Tetrafluoroethane and Ethylene oxide mixture, with not more than 5.6% Ethylene oxide	126	3299			

Name of Material	Guide No.	ID No.	Name of Material	Guide No.	ID No.
Thiocarbamate pesticide, liquid, toxic, flammable	131	3005	2,4-Toluenediamine, solution	151	3418
Thiocarbamate pesticide, solid, poisonous	151	2771	Toluene diisocyanate	156	2078
Thiocarbamate pesticide, solid, toxic	151	2771	Toluidines, liquid	153	1708
Thioglycol	153	2966	Toluidines, solid	153	3451
Thioglycolic acid	153	1940	2,4-Toluylenediamine, solid	151	1709
Thiolactic acid	153	2936	2,4-Toluylenediamine, solution	151	3418
Thionyl chloride	137	1836	Toxic by inhalation liquid, corrosive, flammable, n.o.s. (Inhalation Hazard Zone A)	131	3492
Thiophene	130	2414	Toxic by inhalation liquid, corrosive, flammable, n.o.s. (Inhalation Hazard Zone B)	131	3493
Thiophosgene	157	2474	Toxic by inhalation liquid, corrosive, n.o.s. (Inhalation Hazard Zone A)	154	3389
Thiophosphoryl chloride	157	1837	Toxic by inhalation liquid, corrosive, n.o.s. (Inhalation Hazard Zone B)	154	3390
Thiourea dioxide	135	3341	Toxic by inhalation liquid, flammable, corrosive, n.o.s. (Inhalation Hazard Zone A)	131	3488
Tinctures, medicinal	127	1293	Toxic by inhalation liquid, flammable, corrosive, n.o.s. (Inhalation Hazard Zone B)	131	3489
Tin tetrachloride	137	1827	Toxic by inhalation liquid, flammable, n.o.s. (Inhalation Hazard Zone A)	131	3383
Titanium disulfide	135	3174	Toxic by inhalation liquid, flammable, n.o.s. (Inhalation Hazard Zone B)	131	3384
Titanium disulphide	135	3174	Toxic by inhalation liquid, n.o.s. (Inhalation Hazard Zone A)	151	3381
Titanium hydride	170	1871	Toxic by inhalation liquid, n.o.s. (Inhalation Hazard Zone B)	151	3382
Titanium powder, dry	135	2546	Toxic by inhalation liquid, oxidizing, n.o.s. (Inhalation Hazard Zone A)	142	3387
Titanium powder, wetted with not less than 25% water	170	1352	Toxic by inhalation liquid, oxidizing, n.o.s. (Inhalation Hazard Zone B)	142	3388
Titanium sponge granules	170	2878	Toluene	130	1294
Titanium sponge powders	170	2878	2,4-Toluenediamine, solid	151	1709
Titanium tetrachloride	137	1838			
Titanium trichloride, pyrophoric	135	2441			
Titanium trichloride mixture	157	2869			
Titanium trichloride mixture, pyrophoric	135	2441			
TNT, wetted with not less than 10% water	113	3366			
TNT, wetted with not less than 30% water	113	1356			

Name of Material	Guide No.	ID No.
------------------	-----------	--------

Name of Material	Guide No.	ID No.
------------------	-----------	--------

Toxic by inhalation liquid, water-reactive, flammable, n.o.s. (Inhalation Hazard Zone A)	155	3490
Toxic by inhalation liquid, water-reactive, flammable, n.o.s. (Inhalation Hazard Zone B)	155	3491
Toxic by inhalation liquid, water-reactive, n.o.s. (Inhalation Hazard Zone A)	139	3385
Toxic by inhalation liquid, water-reactive, n.o.s. (Inhalation Hazard Zone B)	139	3386
Toxic liquid, corrosive, inorganic, n.o.s.	154	3289
Toxic liquid, corrosive, organic, n.o.s.	154	2927
Toxic liquid, flammable, organic, n.o.s.	131	2929
Toxic liquid, inorganic, n.o.s.	151	3287
Toxic liquid, organic, n.o.s.	153	2810
Toxic liquid, oxidizing, n.o.s.	142	3122
Toxic liquid, water-reactive, n.o.s.	139	3123
Toxic solid, corrosive, inorganic, n.o.s.	154	3290
Toxic solid, corrosive, organic, n.o.s.	154	2928
Toxic solid, flammable, inorganic, n.o.s.	134	3535
Toxic solid, flammable, organic, n.o.s.	134	2930
Toxic solid, inorganic, n.o.s.	151	3288
Toxic solid, organic, n.o.s.	154	2811
Toxic solid, oxidizing, n.o.s.	141	3086
Toxic solid, self-heating, n.o.s.	136	3124
Toxic solid, water-reactive, n.o.s.	139	3125

Toxins	153	---
Toxins, extracted from living sources, liquid, n.o.s.	153	3172
Toxins, extracted from living sources, solid, n.o.s.	153	3462
Triallylamine	132	2610
Triallyl borate	156	2609
Triazine pesticide, liquid, flammable, poisonous	131	2764
Triazine pesticide, liquid, flammable, toxic	131	2764
Triazine pesticide, liquid, poisonous	151	2998
Triazine pesticide, liquid, poisonous, flammable	131	2997
Triazine pesticide, liquid, toxic	151	2998
Triazine pesticide, liquid, toxic, flammable	131	2997
Triazine pesticide, solid, poisonous	151	2763
Triazine pesticide, solid, toxic	151	2763
Tributylamine	153	2542
Tributylphosphane	135	3254
Trichloroacetic acid	153	1839
Trichloroacetic acid, solution	153	2564
Trichloroacetyl chloride	156	2442
Trichlorobenzenes, liquid	153	2321
Trichlorobutene	152	2322
1,1,1-Trichloroethane	160	2831
Trichloroethylene	160	1710
Trichloroisocyanuric acid, dry	140	2468
Trichlorosilane	139	1295
Tricresyl phosphate	151	2574
Triethylamine	132	1296
Triethylenetetramine	153	2259

Name of Material	Guide No.	ID No.	Name of Material	Guide No.	ID No.
Triethyl phosphite	130	2323	Trinitrobenzoic acid, wetted with not less than 10% water	113	3368
Trifluoroacetic acid	154	2699	Trinitrobenzoic acid, wetted with not less than 30% water	113	1355
Trifluoroacetyl chloride	125	3057	Trinitrochlorobenzene, wetted with not less than 10% water	113	3365
Trifluorochloroethylene, stabilized	119P	1082	Trinitrophenol, wetted with not less than 10% water	113	3364
1,1,1-Trifluoroethane	115	2035	Trinitrophenol, wetted with not less than 30% water	113	1344
Trifluoromethane	126	1984	Trinitrotoluene, wetted with not less than 10% water	113	3366
Trifluoromethane, refrigerated liquid	120	3136	Trinitrotoluene, wetted with not less than 30% water	113	1356
Trifluoromethane and Chlorotrifluoromethane azeotropic mixture with approximately 60% Chlorotrifluoromethane	126	2599	Tripropylamine	132	2260
2-Trifluoromethylaniline	153	2942	Tripropylene	128	2057
3-Trifluoromethylaniline	153	2948	Tris-(1-aziridinyl)phosphine oxide, solution	152	2501
Triisobutylene	128	2324	Tungsten hexafluoride	125	2196
Triisopropyl borate	129	2616	Turpentine	128	1299
Trimethoxysilane	132	9269	Turpentine substitute	128	1300
Trimethylacetyl chloride	131	2438	Undecane	128	2330
Trimethylamine, anhydrous	118	1083	Uranium hexafluoride, radioactive material, excepted package, less than 0.1 kg per package, non-fissile or fissile-excepted	166	3507
Trimethylamine, aqueous solution	132	1297	Uranium hexafluoride, radioactive material, fissile	166	2977
1,3,5-Trimethylbenzene	129	2325	Uranium hexafluoride, radioactive material, non fissile or fissile-excepted	166	2978
Trimethyl borate	129	2416	Urea hydrogen peroxide	140	1511
Trimethylchlorosilane	155	1298	Urea nitrate, wetted with not less than 10% water	113	3370
Trimethylcyclohexylamine	153	2326	Urea nitrate, wetted with not less than 20% water	113	1357
Trimethylhexamethylenediamines	153	2327	Valeraldehyde	129	2058
Trimethylhexamethylene diisocyanate	156	2328	Valeryl chloride	132	2502
Trimethyl phosphite	130	2329			
Trinitrobenzene, wetted with not less than 10% water	113	3367			
Trinitrobenzene, wetted with not less than 30% water	113	1354			

Name of Material	Guide No.	ID No.	Name of Material	Guide No.	ID No.
Vanadium compound, n.o.s.	151	3285	Water-reactive liquid, poisonous, n.o.s.	139	3130
Vanadium oxytrichloride	137	2443	Water-reactive liquid, toxic, n.o.s.	139	3130
Vanadium pentoxide	151	2862	Water-reactive solid, corrosive, n.o.s.	138	3131
Vanadium tetrachloride	137	2444	Water-reactive solid, flammable, n.o.s.	138	3132
Vanadium trichloride	157	2475	Water-reactive solid, n.o.s.	138	2813
Vanadyl sulfate	151	2931	Water-reactive solid, oxidizing, n.o.s.	138	3133
Vanadyl sulphate	151	2931	Water-reactive solid, poisonous, n.o.s.	139	3134
Vehicle, flammable gas powered	115	3166	Water-reactive solid, self-heating, n.o.s.	138	3135
Vehicle, flammable liquid powered	128	3166	Water-reactive solid, toxic, n.o.s.	139	3134
Vehicle, fuel cell, flammable gas powered	115	3166	Wheelchair, electric, with batteries	154	3171
Vehicle, fuel cell, flammable liquid powered	128	3166	White asbestos	171	2590
Vinyl acetate, stabilized	129P	1301	White phosphorus, dry or under water or in solution	136	1381
Vinyl bromide, stabilized	116P	1085	White phosphorus, molten	136	2447
Vinyl butyrate, stabilized	129P	2838	Wood preservatives, liquid	129	1306
Vinyl chloride, stabilized	116P	1086	Wool waste, wet	133	1387
Vinyl chloroacetate	155	2589	Xanthates	135	3342
Vinyl ethyl ether, stabilized	127P	1302	Xenon	120	2036
Vinyl fluoride, stabilized	116P	1860	Xenon, compressed	120	2036
Vinylidene chloride, stabilized	130P	1303	Xenon, refrigerated liquid (cryogenic liquid)	120	2591
Vinyl isobutyl ether, stabilized	127P	1304	Xylenes	130	1307
Vinyl methyl ether, stabilized	116P	1087	Xylenols, liquid	153	3430
Vinylpyridines, stabilized	131P	3073	Xylenols, solid	153	2261
Vinyltoluenes, stabilized	130P	2618	Xylidines, liquid	153	1711
Vinyltrichlorosilane	155P	1305	Xylidines, solid	153	3452
Vinyltrichlorosilane, stabilized	155P	1305	Xylyl bromide, liquid	152	1701
VX	153	—			
Water-reactive liquid, corrosive, n.o.s.	138	3129			
Water-reactive liquid, n.o.s.	138	3148			

Name of Material	Guide No.	ID No.	Name of Material	Guide No.	ID No.
Xylyl bromide, solid	152	3417	Zirconium, dry, finished sheets, strips or coiled wire	135	2009
Yellow phosphorus, dry or under water or in solution	136	1381	Zirconium hydride	138	1437
Zinc ammonium nitrite	140	1512	Zirconium nitrate	140	2728
Zinc arsenate	151	1712	Zirconium picramate, wetted with not less than 20% water	113	1517
Zinc arsenate and Zinc arsenite mixture	151	1712	Zirconium powder, dry	135	2008
Zinc arsenite	151	1712	Zirconium powder, wetted with not less than 25% water	170	1358
Zinc arsenite and Zinc arsenate mixture	151	1712	Zirconium scrap	135	1932
Zinc ashes	138	1435	Zirconium suspended in a flammable liquid	170	1308
Zinc bromate	140	2469	Zirconium suspended in a liquid (flammable)	170	1308
Zinc chlorate	140	1513	Zirconium tetrachloride	137	2503
Zinc chloride, anhydrous	154	2331			
Zinc chloride, solution	154	1840			
Zinc cyanide	151	1713			
Zinc dithionite	171	1931			
Zinc dross	138	1435			
Zinc dust	138	1436			
Zinc fluorosilicate	151	2855			
Zinc hydrosulfite	171	1931			
Zinc hydrosulphite	171	1931			
Zinc nitrate	140	1514			
Zinc permanganate	140	1515			
Zinc peroxide	143	1516			
Zinc phosphide	139	1714			
Zinc powder	138	1436			
Zinc residue	138	1435			
Zinc resinate	133	2714			
Zinc silicofluoride	151	2855			
Zinc skimmings	138	1435			
Zirconium, dry, coiled wire, finished metal sheets or strip	170	2858			

NOTES

SUGGESTED OPERATIONS SHOULD ONLY BE PERFORMED BY ADEQUATELY TRAINED AND EQUIPPED PERSONNEL

HOW TO USE THE ORANGE GUIDES

1

GUIDE
117

GASES - TOXIC - FLAMMABLE
(EXTREME HAZARD)

GASES - TOXIC - FLAMMABLE
(EXTREME HAZARD)

GUIDE
117

HEALTH

POTENTIAL HAZARDS

- **TOXIC**, Extremely Hazardous.
 - May be fatal if inhaled or absorbed through skin.
 - Initial odor may be irritating or foul and may deaden your sense of smell.
 - Contact with gas or liquefied gas may cause burns, severe injury and/or frostbite.
 - Fire will produce irritating, corrosive and/or toxic gases.
 - Runoff from fire control or dilution water may cause environmental contamination.

FIRE OR EXPLOSION

- These materials are extremely flammable.
 - May form explosive mixtures with air.
 - May be ignited by heat, sparks or flames.
 - Vapors from liquefied gas are initially heavier than air and spread along ground.
 - Vapors may travel to source of ignition and flash back.
 - Those substances designated with a (P) may polymerize explosively when heated or involved in a fire.
 - Runoff may create fire or explosion hazard.
 - Cylinders exposed to fire may vent and release toxic and flammable gas through pressure relief devices.
 - Containers may explode when heated.
 - Ruptured cylinders may rocket.

PUBLIC SAFETY

- **CALL 911**. Then call emergency response telephone number on shipping paper, if shipping paper not available or no answer, refer to appropriate telephone number listed on the inside back cover.
 - Keep unauthorized personnel away.
 - Stay upwind, uphill and/or upstream.
 - Many gases are heavier than air and will spread along the ground and collect in low or confined areas (sewers, basements, tanks, etc.).
 - Ventilate closed spaces before entering, but only if properly trained and equipped.

PROTECTIVE CLOTHING

- Wear positive pressure self-contained breathing apparatus (SCBA).
- Wear chemical protective clothing that is specifically recommended by the manufacturer when there is **NO RISK OF FIRE**.
- Structural firefighters' protective clothing provides thermal protection but **only limited chemical protection**.

EVACUATION

- Immediate precautionary measure
 - Isolate spill or leak area for at least 100 meters (330 feet) in all directions.
- See **Table 1 - Initial Isolation and Protective Action Distances**.
- Fire
 - If tank, rail car or tank truck is involved in a fire, ISOLATE for 1600 meters (1 mile) in all directions; also, consider initial evacuation for 1600 meters (1 mile) in all directions.



In Canada, an Emergency Response Assistance Plan (ERAP) may be required for this product. Please consult the shipping paper and/or the ERAP Program Section (page 391).

FIRE

EMERGENCY RESPONSE

DO NOT EXTINGUISH A LEAKING GAS FIRE UNLESS LEAK CAN BE STOPPED.

Small Fire

- Dry chemical, CO₂, water spray or regular foam.

Large Fire

- Water spray, fog or regular foam.
- If it can be done safely, move uninvolved containers away from the area around the fire.
- Damaged cylinders should be handled only by specialists.
- **Fire Involving Tanks**
 - Fight fire from maximum distance or use unmanned master stream devices or monitor nozzles.
 - Cool containers with flooding quantities of water until well after fire is out.
 - Do not direct water at source of leak or safety devices; long may occur.
 - Withdraw immediately in case of rising sound from venting safety devices or discoloration of tank.
 - ALWAYS stay away from tanks engulfed in fire.

SPILL OR LEAK

- **ELIMINATE** all ignition sources (no smoking, flares, sparks or flames) from immediate area.
- All equipment used when handling the product must be grounded.
- Do not touch or walk through spilled material.
- Stop leak if you can do it without risk.
- Use water spray to reduce vapors or divert vapor cloud drift. Avoid allowing water runoff to contact spilled material.
- Do not direct water at spill or source of leak.
- If possible, turn leaking containers so that gas escapes rather than liquid.
- Prevent entry into waterways, sewers, basements or confined areas.
- Isolate area until gas has dispersed.
- Consider igniting spill or leak to eliminate toxic gas concerns.

FIRST AID

- Call 911 or emergency medical services.
- Ensure that medical personnel are aware of the material(s) involved and take precautions to protect themselves.
- Move victim to fresh air if it can be done safely.
- Give artificial respiration if victim is not breathing.
- **Do not perform mouth-to-mouth resuscitation if victim ingested or inhaled the substance; wash face and mouth before giving artificial respiration. Use a pocket mask equipped with a one-way valve or other proper respiratory medical device.**
- Administer oxygen if breathing is difficult.
- Remove and isolate contaminated clothing and shoes.
- In case of contact with substance, immediately flush skin or eyes with running water for at least 20 minutes.
- In case of contact with liquefied gas, then frostbitten parts with lukewarm water.
- In case of burns, immediately cool affected skin for as long as possible with cold water. Do not remove clothing if it adheres to skin.
- Keep victim calm and warm.
- Keep victim under observation.
- Effects of contact or inhalation may be delayed.

2

3

4

1

GUIDE NUMBER AND TITLE

- The guide title identifies the general hazards associated with the materials in this Guide.

2

POTENTIAL HAZARDS

- Emergency responders should consult this section first!
- Describes the material hazard in terms of **FIRE OR EXPLOSION** and **HEALTH** effects upon exposure.
- The primary potential hazard is listed first.
- Allows the responders to make decisions to protect the emergency response team, and the surrounding population.

SUGGESTED OPERATIONS SHOULD ONLY BE PERFORMED BY ADEQUATELY TRAINED AND EQUIPPED PERSONNEL

3

PUBLIC SAFETY

- This section is divided into three subsections:
 - › **General Information:** describes initial precautionary measures to be taken by those first on the scene.
 - › **PROTECTIVE CLOTHING:** provides general guidance on personal protective equipment requirements including respiratory protection. The protective clothing information is general and correct selection is situation dependent, after considering the physical and chemical properties of the material, weather conditions, spill versus fire, topography, etc.
 - › **EVACUATION:** suggests protective distances for immediate precautionary measures defined for small and large spills, including suggested guidance for conditions where fire is present or likely (potential fragmentation hazard).
 - The term “isolate” indicates a zone of no entry that applies to the public and first responders who are not equipped, trained, and prepared to mitigate the incident.
 - The term “evacuate” indicates people should be removed from inside this zone, if it can be done safely. If removal is too risky, sheltering-in-place can also be considered in this zone. Evacuation aims to protect as many people as possible, and applies mainly to the public.
- Materials **highlighted in green** in the yellow-bordered and blue-bordered pages direct the reader to consult Table 1, detailing specific response distances for toxic inhalation hazard materials, water-reactive materials and chemical warfare agents (green-bordered pages).
 -  ■ If a Canadian flag appears in this section, and the incident is located in Canada, an Emergency Response Assistance Plan (ERAP) may be required for this product.

4

EMERGENCY RESPONSE

- This section is divided into three subsections:
 - › **FIRE:** provides extinguishing procedures for **Small Fire**, **Large Fire**, and/or **Fire Involving Tanks or Car/Trailer Loads**
 - › **SPILL OR LEAK:** includes general recommendations, and may describe the response procedure for **Small Spill** and **Large Spill**
 - › **FIRST AID:** provides general guidance prior to seeking expert medical care.

POTENTIAL HAZARDS

FIRE OR EXPLOSION

- May explode from heat, shock, friction or contamination.
- May react violently or explosively on contact with air, water or foam.
- May be ignited by heat, sparks or flames.
- Vapors may travel to source of ignition and flash back.
- Containers may explode when heated.
- Ruptured cylinders may rocket.

HEALTH

- Inhalation, ingestion or contact with substance may cause severe injury, infection, disease or death.
- High concentration of gas may cause asphyxiation without warning.
- Contact may cause burns to skin and eyes.
- Fire or contact with water may produce irritating, toxic and/or corrosive gases.
- Runoff from fire control or dilution water may cause environmental contamination.

PUBLIC SAFETY

- **CALL 911. Then call emergency response telephone number on shipping paper.** If shipping paper not available or no answer, refer to appropriate telephone number listed on the inside back cover.
- Keep unauthorized personnel away.
- Stay upwind, uphill and/or upstream.

PROTECTIVE CLOTHING

- Wear positive pressure self-contained breathing apparatus (SCBA).
- Structural firefighters' protective clothing provides thermal protection **but only limited chemical protection.**

EVACUATION

Immediate precautionary measure

- Isolate spill or leak area for at least 100 meters (330 feet) in all directions.

Fire

- If tank, rail car or tank truck is involved in a fire, ISOLATE for 800 meters (1/2 mile) in all directions; also, consider initial evacuation for 800 meters (1/2 mile) in all directions.

EMERGENCY RESPONSE

FIRE

CAUTION: Material may react with extinguishing agent.

Small Fire

- Dry chemical, CO₂, water spray or regular foam.

Large Fire

- Water spray, fog or regular foam.
- If it can be done safely, move undamaged containers away from the area around the fire.

Fire Involving Tanks

- Cool containers with flooding quantities of water until well after fire is out.
- Do not get water inside containers.
- Withdraw immediately in case of rising sound from venting safety devices or discoloration of tank.
- ALWAYS stay away from tanks engulfed in fire.

SPILL OR LEAK

- Do not touch or walk through spilled material.
- ELIMINATE all ignition sources (no smoking, flares, sparks or flames) from immediate area.
- All equipment used when handling the product must be grounded.
- Keep combustibles (wood, paper, oil, etc.) away from spilled material.
- Use water spray to reduce vapors or divert vapor cloud drift. Avoid allowing water runoff to contact spilled material.
- Prevent entry into waterways, sewers, basements or confined areas.

Small Spill

- Pick up with sand or other non-combustible absorbent material and place into containers for later disposal.

Large Spill

- Dike far ahead of liquid spill for later disposal.

FIRST AID

- Call 911 or emergency medical service.
- Ensure that medical personnel are aware of the material(s) involved and take precautions to protect themselves.
- Move victim to fresh air if it can be done safely.
- Give artificial respiration if victim is not breathing.
- **Do not perform mouth-to-mouth resuscitation if victim ingested or inhaled the substance; wash face and mouth before giving artificial respiration. Use a pocket mask equipped with a one-way valve or other proper respiratory medical device.**
- Administer oxygen if breathing is difficult.
- Remove and isolate contaminated clothing and shoes.
- In case of contact with substance, immediately flush skin or eyes with running water for at least 20 minutes.
- Shower and wash with soap and water.
- Keep victim calm and warm.
- Effects of exposure (inhalation, ingestion or skin contact) to substance may be delayed.

GUIDE EXPLOSIVES* - DIVISION 1.1, 1.2, 1.3 OR 1.5

112

POTENTIAL HAZARDS

FIRE OR EXPLOSION

- **MAY EXPLODE AND THROW FRAGMENTS 1600 METERS (1 MILE) OR MORE IF FIRE REACHES CARGO.**
- For information on "Compatibility Group" letters, refer to Glossary section.

HEALTH

- Fire may produce irritating, corrosive and/or toxic gases.

PUBLIC SAFETY

- **CALL 911. Then call emergency response telephone number on shipping paper.** If shipping paper not available or no answer, refer to appropriate telephone number listed on the inside back cover.
- Move people out of line of sight of the scene and away from windows.
- Keep unauthorized personnel away.
- Stay upwind, uphill and/or upstream.
- Ventilate closed spaces before entering, but only if properly trained and equipped.

PROTECTIVE CLOTHING

- Wear positive pressure self-contained breathing apparatus (SCBA).
- Structural firefighters' protective clothing provides thermal protection **but only limited chemical protection.**

EVACUATION

Immediate precautionary measure

- Isolate spill or leak area immediately for at least 500 meters (1/3 mile) in all directions.

Large Spill

- **Consider initial evacuation for 800 meters (1/2 mile) in all directions.**

Fire

- If rail car or trailer is involved in a fire, ISOLATE for 1600 meters (1 mile) in all directions; also, initiate evacuation including emergency responders for 1600 meters (1 mile) in all directions.



In Canada, an Emergency Response Assistance Plan (ERAP) may be required for this product. Please consult the shipping paper and/or the ERAP Program Section (page 390).

*** FOR INFORMATION ON "COMPATIBILITY GROUP" LETTERS, REFER TO THE GLOSSARY SECTION.**

EMERGENCY RESPONSE

FIRE

CARGO Fire

- **DO NOT fight fire when fire reaches cargo! Cargo may EXPLODE!**
- Stop all traffic and clear the area for at least 1600 meters (1 mile) in all directions and let burn.
- **Do not move cargo or vehicle if cargo has been exposed to heat.**

TIRE or VEHICLE Fire

- **Use plenty of water - FLOOD it! If water is not available, use CO₂, dry chemical or dirt.**
- If possible, and WITHOUT RISK, use unmanned master stream devices or monitor nozzles from maximum distance to prevent fire from spreading to cargo area.
- Pay special attention to tire fires as re-ignition may occur. Stand by, at a safe distance, with extinguisher ready for possible re-ignition.

SPILL OR LEAK

- ELIMINATE all ignition sources (no smoking, flares, sparks or flames) from immediate area.
- All equipment used when handling the product must be grounded.
- Do not touch or walk through spilled material.
- **DO NOT OPERATE RADIO TRANSMITTERS WITHIN 100 METERS (330 FEET) OF ELECTRIC DETONATORS.**
- **DO NOT CLEAN-UP OR DISPOSE OF, EXCEPT UNDER SUPERVISION OF A SPECIALIST.**

FIRST AID

- Call 911 or emergency medical service.
- Ensure that medical personnel are aware of the material(s) involved and take precautions to protect themselves.
- Move victim to fresh air if it can be done safely.
- Give artificial respiration if victim is not breathing.
- Administer oxygen if breathing is difficult.
- Remove and isolate contaminated clothing and shoes.
- In case of contact with substance, immediately flush skin or eyes with running water for at least 20 minutes.

* FOR INFORMATION ON "COMPATIBILITY GROUP" LETTERS, REFER TO THE GLOSSARY SECTION.

GUIDE 113 FLAMMABLE MATERIALS (WET/DESENSITIZED EXPLOSIVE)

POTENTIAL HAZARDS

FIRE OR EXPLOSION

- Flammable/combustible material.
- May be ignited by heat, sparks or flames.
- **DRIED OUT material may explode if exposed to heat, flame, friction or shock; treat as an explosive (GUIDE 112).**
- **Keep material wet with water or treat as an explosive (GUIDE 112).**
- Runoff to sewer may create fire or explosion hazard.

HEALTH

- **Some are toxic** and may be fatal if inhaled, ingested or absorbed through skin. Specifically, Dinitrophenol, wetted (UN1320); Dinitrophenolates, wetted (UN1321), Sodium dinitro-o-cresolate, wetted (UN1348); and Barium azide, wetted (UN1571) are known to be toxic.
- Contact may cause burns to skin and eyes.
- Fire may produce irritating, corrosive and/or toxic gases.
- Runoff from fire control or dilution water may cause environmental contamination.

PUBLIC SAFETY

- **CALL 911. Then call emergency response telephone number on shipping paper.** If shipping paper not available or no answer, refer to appropriate telephone number listed on the inside back cover.
- Keep unauthorized personnel away.
- Stay upwind, uphill and/or upstream.
- Ventilate closed spaces before entering, but only if properly trained and equipped.

PROTECTIVE CLOTHING

- Wear positive pressure self-contained breathing apparatus (SCBA).
- Structural firefighters' protective clothing provides thermal protection **but only limited chemical protection.**

EVACUATION

Immediate precautionary measure

- Isolate spill or leak area immediately for at least 100 meters (330 feet) in all directions.

Large Spill

- **Consider initial evacuation for 500 meters (1/3 mile) in all directions.**

Fire

- If tank, rail car or tank truck is involved in a fire, ISOLATE for 800 meters (1/2 mile) in all directions; also, consider initial evacuation for 800 meters (1/2 mile) in all directions.



In Canada, an Emergency Response Assistance Plan (ERAP) may be required for this product. Please consult the shipping paper and/or the ERAP Program Section (page 390).

EMERGENCY RESPONSE

FIRE

CARGO Fire

- **DO NOT fight fire when fire reaches cargo! Cargo may EXPLODE!**
- Stop all traffic and clear the area for at least 1600 meters (1 mile) in all directions and let burn.
- **Do not move cargo or vehicle if cargo has been exposed to heat.**

TIRE or VEHICLE Fire

- **Use plenty of water - FLOOD it! If water is not available, use CO₂, dry chemical or dirt.**
- If possible, and WITHOUT RISK, use unmanned master stream devices or monitor nozzles from maximum distance to prevent fire from spreading to cargo area.
- Pay special attention to tire fires as re-ignition may occur. Stand by, at a safe distance, with extinguisher ready for possible re-ignition.

SPILL OR LEAK

- ELIMINATE all ignition sources (no smoking, flares, sparks or flames) from immediate area.
- All equipment used when handling the product must be grounded.
- Do not touch or walk through spilled material.

Small Spill

- Flush area with large amounts of water.

Large Spill

- Wet down with water and dike for later disposal.
- **KEEP "WETTED" PRODUCT WET BY SLOWLY ADDING FLOODING QUANTITIES OF WATER.**

FIRST AID

- Call 911 or emergency medical service.
- Ensure that medical personnel are aware of the material(s) involved and take precautions to protect themselves.
- Move victim to fresh air if it can be done safely.
- Give artificial respiration if victim is not breathing.
- Administer oxygen if breathing is difficult.
- Remove and isolate contaminated clothing and shoes.
- In case of contact with substance, immediately flush skin or eyes with running water for at least 20 minutes.

GUIDE EXPLOSIVES* - DIVISION 1.4 OR 1.6

114

POTENTIAL HAZARDS

FIRE OR EXPLOSION

- **MAY EXPLODE AND THROW FRAGMENTS 800 METERS (1/2 MILE) OR MORE IF FIRE REACHES CARGO.**
- For information on "Compatibility Group" letters, refer to Glossary section.

HEALTH

- Fire may produce irritating, corrosive and/or toxic gases.

PUBLIC SAFETY

- **CALL 911. Then call emergency response telephone number on shipping paper.** If shipping paper not available or no answer, refer to appropriate telephone number listed on the inside back cover.
- Move people out of line of sight of the scene and away from windows.
- Keep unauthorized personnel away.
- Stay upwind, uphill and/or upstream.
- Ventilate closed spaces before entering, but only if properly trained and equipped.

PROTECTIVE CLOTHING

- Wear positive pressure self-contained breathing apparatus (SCBA).
- Structural firefighters' protective clothing provides thermal protection **but only limited chemical protection.**

EVACUATION

Immediate precautionary measure

- Isolate spill or leak area immediately for at least 100 meters (330 feet) in all directions.

Large Spill

- **Consider initial evacuation for 250 meters (800 feet) in all directions.**

Fire

- If rail car or trailer is involved in a fire, ISOLATE for 800 meters (1/2 mile) in all directions; also initiate evacuation including emergency responders for 800 meters (1/2 mile) in all directions.
- If fire threatens cargo area containing packages bearing the 1.4S label or packages containing material classified as 1.4S, consider isolating at least 15 meters (50 feet) in all directions.



In Canada, an Emergency Response Assistance Plan (ERAP) may be required for this product. Please consult the shipping paper and/or the ERAP Program Section (page 390).

*** FOR INFORMATION ON "COMPATIBILITY GROUP" LETTERS, REFER TO THE GLOSSARY SECTION.**

EMERGENCY RESPONSE**FIRE****CARGO Fire**

- **DO NOT fight fire when fire reaches cargo! Cargo may EXPLODE!**
- Stop all traffic and clear the area for at least 800 meters (1/2 mile) in all directions and let burn.
- **Do not move cargo or vehicle if cargo has been exposed to heat.**

TIRE or VEHICLE Fire

- **Use plenty of water - FLOOD it! If water is not available, use CO₂, dry chemical or dirt.**
- If possible, and WITHOUT RISK, use unmanned master stream devices or monitor nozzles from maximum distance to prevent fire from spreading to cargo area.
- Pay special attention to tire fires as re-ignition may occur. Stand by, at a safe distance, with extinguisher ready for possible re-ignition.

CLASS 1.4S Fire

- Packages bearing the 1.4S label or packages containing material classified as 1.4S are designed or packaged in such a manner that when involved in a fire, they may burn vigorously with localized detonations and projection of fragments.
- Effects are usually confined to immediate vicinity of packages.
- Fight fire with normal precautions from a reasonable distance.

SPILL OR LEAK

- **ELIMINATE** all ignition sources (no smoking, flares, sparks or flames) from immediate area.
- All equipment used when handling the product must be grounded.
- Do not touch or walk through spilled material.
- **DO NOT OPERATE RADIO TRANSMITTERS WITHIN 100 METERS (330 FEET) OF ELECTRIC DETONATORS.**
- **DO NOT CLEAN-UP OR DISPOSE OF, EXCEPT UNDER SUPERVISION OF A SPECIALIST.**

FIRST AID

- Call 911 or emergency medical service.
- Ensure that medical personnel are aware of the material(s) involved and take precautions to protect themselves.
- Move victim to fresh air if it can be done safely.
- Give artificial respiration if victim is not breathing.
- Administer oxygen if breathing is difficult.
- Remove and isolate contaminated clothing and shoes.
- In case of contact with substance, immediately flush skin or eyes with running water for at least 20 minutes.

* **FOR INFORMATION ON "COMPATIBILITY GROUP" LETTERS, REFER TO THE GLOSSARY SECTION.**

GUIDE 115 GASES - FLAMMABLE (INCLUDING REFRIGERATED LIQUIDS)

POTENTIAL HAZARDS

FIRE OR EXPLOSION

• EXTREMELY FLAMMABLE.

- Will be easily ignited by heat, sparks or flames.
- Will form explosive mixtures with air.
- Vapors from liquefied gas are initially heavier than air and spread along ground.

CAUTION: Hydrogen (UN1049), Deuterium (UN1957), Hydrogen, refrigerated liquid (UN1966), Methane (UN1971) and Hydrogen and Methane mixture, compressed (UN2034) are lighter than air and will rise. Hydrogen and Deuterium fires are difficult to detect since they burn with an invisible flame. Use an alternate method of detection (thermal camera, broom handle, etc.)

- Vapors may travel to source of ignition and flash back.
- Cylinders exposed to fire may vent and release flammable gas through pressure relief devices.
- Containers may explode when heated.
- Ruptured cylinders may rocket.

HEALTH

- Vapors may cause dizziness or asphyxiation without warning.
- Some may be irritating if inhaled at high concentrations.
- Contact with gas or liquefied gas may cause burns, severe injury and/or frostbite.
- Fire may produce irritating and/or toxic gases.

PUBLIC SAFETY

- **CALL 911. Then call emergency response telephone number on shipping paper.** If shipping paper not available or no answer, refer to appropriate telephone number listed on the inside back cover.
- Keep unauthorized personnel away.
- Stay upwind, uphill and/or upstream.
- Many gases are heavier than air and will spread along the ground and collect in low or confined areas (sewers, basements, tanks, etc.).

PROTECTIVE CLOTHING

- Wear positive pressure self-contained breathing apparatus (SCBA).
- Structural firefighters' protective clothing provides thermal protection **but only limited chemical protection.**
- Always wear thermal protective clothing when handling refrigerated/cryogenic liquids.

EVACUATION

Immediate precautionary measure

- Isolate spill or leak area for at least 100 meters (330 feet) in all directions.

Large Spill

- Consider initial downwind evacuation for at least 800 meters (1/2 mile).

Fire

- If tank, rail car or tank truck is involved in a fire, ISOLATE for 1600 meters (1 mile) in all directions; also, consider initial evacuation for 1600 meters (1 mile) in all directions.
- In fires involving Liquefied Petroleum Gases (LPG) (UN1075), Butane (UN1011), Butylene (UN1012), Isobutylene (UN1055), Propylene (UN1077), Isobutane (UN1969), and Propane (UN1978), also refer to BLEVE – SAFETY PRECAUTIONS (Page 366).



In Canada, an Emergency Response Assistance Plan (ERAP) may be required for this product. Please consult the shipping paper and/or the ERAP Program Section (page 390).

EMERGENCY RESPONSE

FIRE

- **DO NOT EXTINGUISH A LEAKING GAS FIRE UNLESS LEAK CAN BE STOPPED.**

CAUTION: Hydrogen (UN1049), Deuterium (UN1957), Hydrogen, refrigerated liquid (UN1966) and Hydrogen and Methane mixture, compressed (UN2034) will burn with an invisible flame. Use an alternate method of detection (thermal camera, broom handle, etc.)

Small Fire

- Dry chemical or CO₂.

Large Fire

- Water spray or fog.
- If it can be done safely, move undamaged containers away from the area around the fire.

CAUTION: For LNG - Liquefied natural gas (UN1972) pool fires, DO NOT USE water. Use dry chemical or high-expansion foam.

Fire Involving Tanks

- Fight fire from maximum distance or use unmanned master stream devices or monitor nozzles.
- Cool containers with flooding quantities of water until well after fire is out.
- Do not direct water at source of leak or safety devices; icing may occur.
- Withdraw immediately in case of rising sound from venting safety devices or discoloration of tank.
- ALWAYS stay away from tanks engulfed in fire.
- For massive fire, use unmanned master stream devices or monitor nozzles; if this is impossible, withdraw from area and let fire burn.

SPILL OR LEAK

- ELIMINATE all ignition sources (no smoking, flares, sparks or flames) from immediate area.
- All equipment used when handling the product must be grounded.
- Do not touch or walk through spilled material.
- Stop leak if you can do it without risk.
- If possible, turn leaking containers so that gas escapes rather than liquid.
- Use water spray to reduce vapors or divert vapor cloud drift. Avoid allowing water runoff to contact spilled material.
- Do not direct water at spill or source of leak.

CAUTION: For LNG - Liquefied natural gas (UN1972), DO NOT apply water, regular or alcohol-resistant foam directly on spill. Use a high-expansion foam if available to reduce vapors.

- Prevent spreading of vapors through sewers, ventilation systems and confined areas.
- Isolate area until gas has dispersed.

CAUTION: When in contact with refrigerated/cryogenic liquids, many materials become brittle and are likely to break without warning.

FIRST AID

- Call 911 or emergency medical service.
- Ensure that medical personnel are aware of the material(s) involved and take precautions to protect themselves.
- Move victim to fresh air if it can be done safely.
- Give artificial respiration if victim is not breathing.
- Administer oxygen if breathing is difficult.
- Remove and isolate contaminated clothing and shoes.
- Clothing frozen to the skin should be thawed before being removed.
- In case of contact with liquefied gas, thaw frosted parts with lukewarm water.
- In case of burns, immediately cool affected skin for as long as possible with cold water. Do not remove clothing if adhering to skin.
 - Keep victim calm and warm.

POTENTIAL HAZARDS

FIRE OR EXPLOSION

- **EXTREMELY FLAMMABLE.**

- Will be easily ignited by heat, sparks or flames.
- Will form explosive mixtures with air. Acetylene (UN1001, UN3374) may react explosively even in the absence of air.
- Silane (UN2203) will ignite spontaneously in air.
- Those substances designated with a **(P)** may polymerize explosively when heated or involved in a fire.
- Vapors from liquefied gas are initially heavier than air and spread along ground.
- Vapors may travel to source of ignition and flash back.
- Cylinders exposed to fire may vent and release flammable gas through pressure relief devices.
- Containers may explode when heated.
- Ruptured cylinders may rocket.

HEALTH

- Vapors may cause dizziness or asphyxiation without warning.
- Some may be toxic if inhaled at high concentrations.
- Contact with gas or liquefied gas may cause burns, severe injury and/or frostbite.
- Fire may produce irritating and/or toxic gases.

PUBLIC SAFETY

- **CALL 911. Then call emergency response telephone number on shipping paper.** If shipping paper not available or no answer, refer to appropriate telephone number listed on the inside back cover.
- Keep unauthorized personnel away.
- Stay upwind, uphill and/or upstream.
- Many gases are heavier than air and will spread along the ground and collect in low or confined areas (sewers, basements, tanks, etc.).

PROTECTIVE CLOTHING

- Wear positive pressure self-contained breathing apparatus (SCBA).
- Structural firefighters' protective clothing provides thermal protection **but only limited chemical protection.**

EVACUATION

Immediate precautionary measure

- Isolate spill or leak area for at least 100 meters (330 feet) in all directions.

Large Spill

- Consider initial downwind evacuation for at least 800 meters (1/2 mile).

Fire

- If tank, rail car or tank truck is involved in a fire, ISOLATE for 1600 meters (1 mile) in all directions; also, consider initial evacuation for 1600 meters (1 mile) in all directions.



In Canada, an Emergency Response Assistance Plan (ERAP) may be required for this product. Please consult the shipping paper and/or the ERAP Program Section (page 390).

EMERGENCY RESPONSE

FIRE

- **DO NOT EXTINGUISH A LEAKING GAS FIRE UNLESS LEAK CAN BE STOPPED.**

Small Fire

- Dry chemical or CO₂.

Large Fire

- Water spray or fog.
- If it can be done safely, move undamaged containers away from the area around the fire.

Fire Involving Tanks

- Fight fire from maximum distance or use unmanned master stream devices or monitor nozzles.
- Cool containers with flooding quantities of water until well after fire is out.
- Do not direct water at source of leak or safety devices; icing may occur.
- Withdraw immediately in case of rising sound from venting safety devices or discoloration of tank.
- ALWAYS stay away from tanks engulfed in fire.
- For massive fire, use unmanned master stream devices or monitor nozzles; if this is impossible, withdraw from area and let fire burn.

SPILL OR LEAK

- ELIMINATE all ignition sources (no smoking, flares, sparks or flames) from immediate area.
- All equipment used when handling the product must be grounded.
- Stop leak if you can do it without risk.
- Do not touch or walk through spilled material.
- Do not direct water at spill or source of leak.
- Use water spray to reduce vapors or divert vapor cloud drift. Avoid allowing water runoff to contact spilled material.
- If possible, turn leaking containers so that gas escapes rather than liquid.
- Prevent entry into waterways, sewers, basements or confined areas.
- Isolate area until gas has dispersed.

FIRST AID

- Call 911 or emergency medical service.
- Ensure that medical personnel are aware of the material(s) involved and take precautions to protect themselves.
- Move victim to fresh air if it can be done safely.
- Give artificial respiration if victim is not breathing.
- Administer oxygen if breathing is difficult.
- Remove and isolate contaminated clothing and shoes.
- In case of contact with liquefied gas, thaw frosted parts with lukewarm water.
- In case of burns, immediately cool affected skin for as long as possible with cold water. Do not remove clothing if adhering to skin.
- Keep victim calm and warm.

GUIDE 117 GASES - TOXIC - FLAMMABLE (EXTREME HAZARD)

POTENTIAL HAZARDS

HEALTH

- **TOXIC; Extremely Hazardous.**
- May be fatal if inhaled or absorbed through skin.
- Initial odor may be irritating or foul and may deaden your sense of smell.
- Contact with gas or liquefied gas may cause burns, severe injury and/or frostbite.
- Fire will produce irritating, corrosive and/or toxic gases.
- Runoff from fire control or dilution water may cause environmental contamination.

FIRE OR EXPLOSION

- These materials are extremely flammable.
- May form explosive mixtures with air.
- May be ignited by heat, sparks or flames.
- Vapors from liquefied gas are initially heavier than air and spread along ground.
- Vapors may travel to source of ignition and flash back.
- Those substances designated with a (P) may polymerize explosively when heated or involved in a fire.
- Runoff may create fire or explosion hazard.
- Cylinders exposed to fire may vent and release toxic and flammable gas through pressure relief devices.
- Containers may explode when heated.
- Ruptured cylinders may rocket.

PUBLIC SAFETY

- **CALL 911. Then call emergency response telephone number on shipping paper.** If shipping paper not available or no answer, refer to appropriate telephone number listed on the inside back cover.
- Keep unauthorized personnel away.
- Stay upwind, uphill and/or upstream.
- Many gases are heavier than air and will spread along the ground and collect in low or confined areas (sewers, basements, tanks, etc.).
- Ventilate closed spaces before entering, but only if properly trained and equipped.

PROTECTIVE CLOTHING

- Wear positive pressure self-contained breathing apparatus (SCBA).
- Wear chemical protective clothing that is specifically recommended by the manufacturer **when there is NO RISK OF FIRE.**
- Structural firefighters' protective clothing provides thermal protection **but only limited chemical protection.**

EVACUATION

Immediate precautionary measure

- Isolate spill or leak area for at least 100 meters (330 feet) in all directions.

Spill

- See [Table 1 - Initial Isolation and Protective Action Distances](#).

Fire

- If tank, rail car or tank truck is involved in a fire, ISOLATE for 1600 meters (1 mile) in all directions; also, consider initial evacuation for 1600 meters (1 mile) in all directions.



In Canada, an Emergency Response Assistance Plan (ERAP) may be required for this product. Please consult the shipping paper and/or the ERAP Program Section (page 390).

EMERGENCY RESPONSE

FIRE

- **DO NOT EXTINGUISH A LEAKING GAS FIRE UNLESS LEAK CAN BE STOPPED.**

Small Fire

- Dry chemical, CO₂, water spray or regular foam.

Large Fire

- Water spray, fog or regular foam.
- If it can be done safely, move undamaged containers away from the area around the fire.
- Damaged cylinders should be handled only by specialists.

Fire Involving Tanks

- Fight fire from maximum distance or use unmanned master stream devices or monitor nozzles.
- Cool containers with flooding quantities of water until well after fire is out.
- Do not direct water at source of leak or safety devices; icing may occur.
- Withdraw immediately in case of rising sound from venting safety devices or discoloration of tank.
- ALWAYS stay away from tanks engulfed in fire.

SPILL OR LEAK

- ELIMINATE all ignition sources (no smoking, flares, sparks or flames) from immediate area.
- All equipment used when handling the product must be grounded.
- Do not touch or walk through spilled material.
- Stop leak if you can do it without risk.
- Use water spray to reduce vapors or divert vapor cloud drift. Avoid allowing water runoff to contact spilled material.
- Do not direct water at spill or source of leak.
- If possible, turn leaking containers so that gas escapes rather than liquid.
- Prevent entry into waterways, sewers, basements or confined areas.
- Isolate area until gas has dispersed.
- Consider igniting spill or leak to eliminate toxic gas concerns.

FIRST AID

- Call 911 or emergency medical service.
- Ensure that medical personnel are aware of the material(s) involved and take precautions to protect themselves.
- Move victim to fresh air if it can be done safely.
- Give artificial respiration if victim is not breathing.
- **Do not perform mouth-to-mouth resuscitation if victim ingested or inhaled the substance; wash face and mouth before giving artificial respiration. Use a pocket mask equipped with a one-way valve or other proper respiratory medical device.**
- Administer oxygen if breathing is difficult.
- Remove and isolate contaminated clothing and shoes.
- In case of contact with substance, immediately flush skin or eyes with running water for at least 20 minutes.
- In case of contact with liquefied gas, thaw frosted parts with lukewarm water.
- In case of burns, immediately cool affected skin for as long as possible with cold water. Do not remove clothing if adhering to skin.
- Keep victim calm and warm.
- Keep victim under observation.
- Effects of contact or inhalation may be delayed.

POTENTIAL HAZARDS

FIRE OR EXPLOSION

- **EXTREMELY FLAMMABLE.**

- May be ignited by heat, sparks or flames.
- May form explosive mixtures with air.
- Vapors from liquefied gas are initially heavier than air and spread along ground.
- Vapors may travel to source of ignition and flash back.
- Some of these materials may react violently with water.
- Cylinders exposed to fire may vent and release flammable gas through pressure relief devices.
- Containers may explode when heated.
- Ruptured cylinders may rocket.

HEALTH

- May cause toxic effects if inhaled.
- Vapors are extremely irritating.
- Contact with gas or liquefied gas may cause burns, severe injury and/or frostbite.
- Fire will produce irritating, corrosive and/or toxic gases.
- Runoff from fire control or dilution water may cause environmental contamination.

PUBLIC SAFETY

- **CALL 911. Then call emergency response telephone number on shipping paper.** If shipping paper not available or no answer, refer to appropriate telephone number listed on the inside back cover.
- Keep unauthorized personnel away.
- Stay upwind, uphill and/or upstream.
- Many gases are heavier than air and will spread along the ground and collect in low or confined areas (sewers, basements, tanks, etc.).
- Ventilate closed spaces before entering, but only if properly trained and equipped.

PROTECTIVE CLOTHING

- Wear positive pressure self-contained breathing apparatus (SCBA).
- Wear chemical protective clothing that is specifically recommended by the manufacturer **when there is NO RISK OF FIRE.**
- Structural firefighters' protective clothing provides thermal protection **but only limited chemical protection.**

EVACUATION

Immediate precautionary measure

- Isolate spill or leak area for at least 100 meters (330 feet) in all directions.

Large Spill

- Consider initial downwind evacuation for at least 800 meters (1/2 mile).

Fire

- If tank, rail car or tank truck is involved in a fire, ISOLATE for 1600 meters (1 mile) in all directions; also, consider initial evacuation for 1600 meters (1 mile) in all directions.



In Canada, an Emergency Response Assistance Plan (ERAP) may be required for this product. Please consult the shipping paper and/or the ERAP Program Section (page 390).

EMERGENCY RESPONSE**FIRE**

- **DO NOT EXTINGUISH A LEAKING GAS FIRE UNLESS LEAK CAN BE STOPPED.**

Small Fire

- Dry chemical or CO₂.

Large Fire

- Water spray, fog or regular foam.
- If it can be done safely, move undamaged containers away from the area around the fire.
- Damaged cylinders should be handled only by specialists.

Fire Involving Tanks

- Fight fire from maximum distance or use unmanned master stream devices or monitor nozzles.
- Cool containers with flooding quantities of water until well after fire is out.
- Do not direct water at source of leak or safety devices; icing may occur.
- Withdraw immediately in case of rising sound from venting safety devices or discoloration of tank.
- ALWAYS stay away from tanks engulfed in fire.

SPILL OR LEAK

- ELIMINATE all ignition sources (no smoking, flares, sparks or flames) from immediate area.
- All equipment used when handling the product must be grounded.
- Do not touch or walk through spilled material.
- Stop leak if you can do it without risk.
- If possible, turn leaking containers so that gas escapes rather than liquid.
- Use water spray to reduce vapors or divert vapor cloud drift. Avoid allowing water runoff to contact spilled material.
- Do not direct water at spill or source of leak.
- Isolate area until gas has dispersed.

FIRST AID

- Call 911 or emergency medical service.
- Ensure that medical personnel are aware of the material(s) involved and take precautions to protect themselves.
- Move victim to fresh air if it can be done safely.
- Give artificial respiration if victim is not breathing.
- **Do not perform mouth-to-mouth resuscitation if victim ingested or inhaled the substance; wash face and mouth before giving artificial respiration. Use a pocket mask equipped with a one-way valve or other proper respiratory medical device.**
- Administer oxygen if breathing is difficult.
- Remove and isolate contaminated clothing and shoes.
- In case of contact with liquefied gas, thaw frosted parts with lukewarm water.
- In case of burns, immediately cool affected skin for as long as possible with cold water. Do not remove clothing if adhering to skin.
- Keep victim calm and warm.
- Keep victim under observation.
- Effects of contact or inhalation may be delayed.

POTENTIAL HAZARDS

HEALTH

- **TOXIC; may be fatal if inhaled or absorbed through skin. Some may cause severe skin burns and eye damage.**
- Contact with gas or liquefied gas may cause burns, severe injury and/or frostbite.
- Fire will produce irritating, corrosive and/or toxic gases.
- Runoff from fire control or dilution water may cause environmental contamination.

FIRE OR EXPLOSION

- Flammable; may be ignited by heat, sparks or flames.
- May form explosive mixtures with air. Ethylene oxide (UN1040) may react explosively even in the absence of air.
- Those substances designated with a **(P)** may polymerize explosively when heated or involved in a fire.
- Vapors from liquefied gas are initially heavier than air and spread along ground.
- Vapors may travel to source of ignition and flash back.
- Some of these materials may react violently with water.
- Cylinders exposed to fire may vent and release toxic and flammable gas through pressure relief devices.
- Containers may explode when heated.
- Ruptured cylinders may rocket.
- Runoff may create fire or explosion hazard.

PUBLIC SAFETY

- **CALL 911. Then call emergency response telephone number on shipping paper.** If shipping paper not available or no answer, refer to appropriate telephone number listed on the inside back cover.
- Keep unauthorized personnel away.
- Stay upwind, uphill and/or upstream.
- Many gases are heavier than air and will spread along the ground and collect in low or confined areas (sewers, basements, tanks, etc.).
- Ventilate closed spaces before entering, but only if properly trained and equipped.

PROTECTIVE CLOTHING

- Wear positive pressure self-contained breathing apparatus (SCBA).
- Wear chemical protective clothing that is specifically recommended by the manufacturer **when there is NO RISK OF FIRE.**
- Structural firefighters' protective clothing provides thermal protection **but only limited chemical protection.**

EVACUATION

Immediate precautionary measure

- Isolate spill or leak area for at least 100 meters (330 feet) in all directions.

Spill

- For **highlighted materials**: see Table 1 - Initial Isolation and Protective Action Distances.
- For non-highlighted materials: increase the immediate precautionary measure distance, in the downwind direction, as necessary.

Fire

- If tank, rail car or tank truck is involved in a fire, ISOLATE for 1600 meters (1 mile) in all directions; also, consider initial evacuation for 1600 meters (1 mile) in all directions.



In Canada, an Emergency Response Assistance Plan (ERAP) may be required for this product. Please consult the shipping paper and/or the ERAP Program Section (page 390).

EMERGENCY RESPONSE

FIRE

- **DO NOT EXTINGUISH A LEAKING GAS FIRE UNLESS LEAK CAN BE STOPPED.**

Small Fire

- Dry chemical, CO₂, water spray or alcohol-resistant foam.

Large Fire

- Water spray, fog or alcohol-resistant foam.
- **FOR CHLOROSILANES, DO NOT USE WATER;** use AFFF alcohol-resistant medium-expansion foam.
- If it can be done safely, move undamaged containers away from the area around the fire.
- Damaged cylinders should be handled only by specialists.

Fire Involving Tanks

- Fight fire from maximum distance or use unmanned master stream devices or monitor nozzles.
- Cool containers with flooding quantities of water until well after fire is out.
- Do not direct water at source of leak or safety devices; icing may occur.
- Withdraw immediately in case of rising sound from venting safety devices or discoloration of tank.
- ALWAYS stay away from tanks engulfed in fire.

SPILL OR LEAK

- ELIMINATE all ignition sources (no smoking, flares, sparks or flames) from immediate area.
- All equipment used when handling the product must be grounded.
- Do not touch or walk through spilled material.
- Stop leak if you can do it without risk.
- Do not direct water at spill or source of leak.
- Use water spray to reduce vapors or divert vapor cloud drift. Avoid allowing water runoff to contact spilled material.
- **FOR CHLOROSILANES,** use AFFF alcohol-resistant medium-expansion foam to reduce vapors.
- If possible, turn leaking containers so that gas escapes rather than liquid.
- Prevent entry into waterways, sewers, basements or confined areas.
- Isolate area until gas has dispersed.

FIRST AID

- Call 911 or emergency medical service.
- Ensure that medical personnel are aware of the material(s) involved and take precautions to protect themselves.
- Move victim to fresh air if it can be done safely.
- Give artificial respiration if victim is not breathing.
- **Do not perform mouth-to-mouth resuscitation if victim ingested or inhaled the substance; wash face and mouth before giving artificial respiration. Use a pocket mask equipped with a one-way valve or other proper respiratory medical device.**
- Administer oxygen if breathing is difficult.
- Remove and isolate contaminated clothing and shoes.
- In case of contact with substance, immediately flush skin or eyes with running water for at least 20 minutes.
- In case of contact with liquefied gas, thaw frosted parts with lukewarm water.
- In case of burns, immediately cool affected skin for as long as possible with cold water. Do not remove clothing if adhering to skin.
- Keep victim calm and warm.
- Keep victim under observation.
- Effects of contact or inhalation may be delayed.

GUIDE 120

GASES - INERT (INCLUDING REFRIGERATED LIQUIDS)

POTENTIAL HAZARDS

HEALTH

- Vapors may cause dizziness or asphyxiation without warning.
- Vapors from liquefied gas are initially heavier than air and spread along ground.
- Contact with gas or liquefied gas may cause burns, severe injury and/or frostbite.

FIRE OR EXPLOSION

- **Non-flammable gases.**
- Containers may explode when heated.
- Ruptured cylinders may rocket.

PUBLIC SAFETY

- **CALL 911. Then call emergency response telephone number on shipping paper.** If shipping paper not available or no answer, refer to appropriate telephone number listed on the inside back cover.
- Keep unauthorized personnel away.
- Stay upwind, uphill and/or upstream.
- Many gases are heavier than air and will spread along the ground and collect in low or confined areas (sewers, basements, tanks, etc.).
- Ventilate closed spaces before entering, but only if properly trained and equipped.

PROTECTIVE CLOTHING

- Wear positive pressure self-contained breathing apparatus (SCBA).
- Structural firefighters' protective clothing provides thermal protection **but only limited chemical protection.**
- Always wear thermal protective clothing when handling refrigerated/cryogenic liquids or solids.

EVACUATION

Immediate precautionary measure

- Isolate spill or leak area for at least 100 meters (330 feet) in all directions.

Large Spill

- Consider initial downwind evacuation for at least 100 meters (330 feet).

Fire

- If tank, rail car or tank truck is involved in a fire, ISOLATE for 800 meters (1/2 mile) in all directions; also, consider initial evacuation for 800 meters (1/2 mile) in all directions.

EMERGENCY RESPONSE

FIRE

- Use extinguishing agent suitable for type of surrounding fire.
- If it can be done safely, move undamaged containers away from the area around the fire.
- Damaged cylinders should be handled only by specialists.

Fire Involving Tanks

- Fight fire from maximum distance or use unmanned master stream devices or monitor nozzles.
- Cool containers with flooding quantities of water until well after fire is out.
- Do not direct water at source of leak or safety devices; icing may occur.
- Withdraw immediately in case of rising sound from venting safety devices or discoloration of tank.
- ALWAYS stay away from tanks engulfed in fire.

SPILL OR LEAK

- Do not touch or walk through spilled material.
- Stop leak if you can do it without risk.
- Use water spray to reduce vapors or divert vapor cloud drift. Avoid allowing water runoff to contact spilled material.
- Do not direct water at spill or source of leak.
- If possible, turn leaking containers so that gas escapes rather than liquid.
- Prevent entry into waterways, sewers, basements or confined areas.
- Allow substance to evaporate.
- Ventilate the area.

CAUTION: When in contact with refrigerated/cryogenic liquids, many materials become brittle and are likely to break without warning.

FIRST AID

- Call 911 or emergency medical service.
- Ensure that medical personnel are aware of the material(s) involved and take precautions to protect themselves.
- Move victim to fresh air if it can be done safely.
- Give artificial respiration if victim is not breathing.
- Administer oxygen if breathing is difficult.
- Clothing frozen to the skin should be thawed before being removed.
- In case of contact with liquefied gas, thaw frosted parts with lukewarm water.
- Keep victim calm and warm.

GUIDE 121

Page intentionally left blank

There are no materials that refer to this guide.

Page intentionally left blank

There are no materials that refer to this guide.

GUIDE 122 GASES - OXIDIZING (INCLUDING REFRIGERATED LIQUIDS)

POTENTIAL HAZARDS

FIRE OR EXPLOSION

- Substance does not burn but will support combustion.
- Some may react explosively with fuels.
- May ignite combustibles (wood, paper, oil, clothing, etc.).
- Vapors from liquefied gas are initially heavier than air and spread along ground.
- Runoff may create fire or explosion hazard.
- Containers may explode when heated.
- Ruptured cylinders may rocket.

HEALTH

- Vapors may cause dizziness or asphyxiation without warning.
- Contact with gas or liquefied gas may cause burns, severe injury and/or frostbite.
- Fire may produce irritating and/or toxic gases.

PUBLIC SAFETY

- **CALL 911. Then call emergency response telephone number on shipping paper.** If shipping paper not available or no answer, refer to appropriate telephone number listed on the inside back cover.
- Keep unauthorized personnel away.
- Stay upwind, uphill and/or upstream.
- Many gases are heavier than air and will spread along the ground and collect in low or confined areas (sewers, basements, tanks, etc.).
- Ventilate closed spaces before entering, but only if properly trained and equipped.

PROTECTIVE CLOTHING

- Wear positive pressure self-contained breathing apparatus (SCBA).
- Wear chemical protective clothing that is specifically recommended by the manufacturer **when there is NO RISK OF FIRE.**
- Structural firefighters' protective clothing provides thermal protection **but only limited chemical protection.**
- Always wear thermal protective clothing when handling refrigerated/cryogenic liquids.

EVACUATION

Immediate precautionary measure

- Isolate spill or leak area for at least 100 meters (330 feet) in all directions.

Large Spill

- Consider initial downwind evacuation for at least 500 meters (1/3 mile).

Fire

- If tank, rail car or tank truck is involved in a fire, ISOLATE for 800 meters (1/2 mile) in all directions; also, consider initial evacuation for 800 meters (1/2 mile) in all directions.



In Canada, an Emergency Response Assistance Plan (ERAP) may be required for this product. Please consult the shipping paper and/or the ERAP Program Section (page 390).

EMERGENCY RESPONSE

FIRE

- Use extinguishing agent suitable for type of surrounding fire.

Small Fire

- Dry chemical or CO₂.

Large Fire

- Water spray, fog or regular foam.
- If it can be done safely, move undamaged containers away from the area around the fire.
- Damaged cylinders should be handled only by specialists.

Fire Involving Tanks

- Fight fire from maximum distance or use unmanned master stream devices or monitor nozzles.
- Cool containers with flooding quantities of water until well after fire is out.
- Do not direct water at source of leak or safety devices; icing may occur.
- Withdraw immediately in case of rising sound from venting safety devices or discoloration of tank.
- ALWAYS stay away from tanks engulfed in fire.
- For massive fire, use unmanned master stream devices or monitor nozzles; if this is impossible, withdraw from area and let fire burn.

SPILL OR LEAK

- Keep combustibles (wood, paper, oil, etc.) away from spilled material.
- Do not touch or walk through spilled material.
- Stop leak if you can do it without risk.
- If possible, turn leaking containers so that gas escapes rather than liquid.
- Do not direct water at spill or source of leak.
- Use water spray to reduce vapors or divert vapor cloud drift. Avoid allowing water runoff to contact spilled material.
- Prevent entry into waterways, sewers, basements or confined areas.
- Allow substance to evaporate.
- Isolate area until gas has dispersed.

CAUTION: When in contact with refrigerated/cryogenic liquids, many materials become brittle and are likely to break without warning.

FIRST AID

- Call 911 or emergency medical service.
- Ensure that medical personnel are aware of the material(s) involved and take precautions to protect themselves.
- Move victim to fresh air if it can be done safely.
- Give artificial respiration if victim is not breathing.
- Administer oxygen if breathing is difficult.
- Remove and isolate contaminated clothing and shoes.
- Clothing frozen to the skin should be thawed before being removed.
- In case of contact with liquefied gas, thaw frosted parts with lukewarm water.
- Keep victim calm and warm.

POTENTIAL HAZARDS

HEALTH

- **TOXIC; may be fatal if inhaled or absorbed through skin.**
- Vapors may be irritating and/or corrosive.
- Contact with gas or liquefied gas may cause burns, severe injury and/or frostbite.
- Fire will produce irritating, corrosive and/or toxic gases.
- Runoff from fire control or dilution water may cause environmental contamination.

FIRE OR EXPLOSION

- Some may burn but none ignite readily.
- Vapors from liquefied gas are initially heavier than air and spread along ground.
- Cylinders exposed to fire may vent and release toxic and/or corrosive gas through pressure relief devices.
- Containers may explode when heated.
- Ruptured cylinders may rocket.

PUBLIC SAFETY

- **CALL 911. Then call emergency response telephone number on shipping paper.** If shipping paper not available or no answer, refer to appropriate telephone number listed on the inside back cover.
- Keep unauthorized personnel away.
- Stay upwind, uphill and/or upstream.
- Many gases are heavier than air and will spread along the ground and collect in low or confined areas (sewers, basements, tanks, etc.).
- Ventilate closed spaces before entering, but only if properly trained and equipped.

PROTECTIVE CLOTHING

- Wear positive pressure self-contained breathing apparatus (SCBA).
- Wear chemical protective clothing that is specifically recommended by the manufacturer **when there is NO RISK OF FIRE.**
- Structural firefighters' protective clothing provides thermal protection **but only limited chemical protection.**

EVACUATION

Immediate precautionary measure

- Isolate spill or leak area for at least 100 meters (330 feet) in all directions.

Spill

- For **highlighted materials**: see Table 1 - Initial Isolation and Protective Action Distances.
- For non-highlighted materials: increase the immediate precautionary measure distance, in the downwind direction, as necessary.

Fire

- If tank, rail car or tank truck is involved in a fire, ISOLATE for 800 meters (1/2 mile) in all directions; also, consider initial evacuation for 800 meters (1/2 mile) in all directions.



In Canada, an Emergency Response Assistance Plan (ERAP) may be required for this product. Please consult the shipping paper and/or the ERAP Program Section (page 390).

EMERGENCY RESPONSE**FIRE****Small Fire**

- Dry chemical or CO₂.

Large Fire

- Water spray, fog or regular foam.
- Do not get water inside containers.
- If it can be done safely, move undamaged containers away from the area around the fire.
- Damaged cylinders should be handled only by specialists.

Fire Involving Tanks

- Fight fire from maximum distance or use unmanned master stream devices or monitor nozzles.
- Cool containers with flooding quantities of water until well after fire is out.
- Do not direct water at source of leak or safety devices; icing may occur.
- Withdraw immediately in case of rising sound from venting safety devices or discoloration of tank.
- ALWAYS stay away from tanks engulfed in fire.

SPILL OR LEAK

- Do not touch or walk through spilled material.
- Stop leak if you can do it without risk.
- If possible, turn leaking containers so that gas escapes rather than liquid.
- Prevent entry into waterways, sewers, basements or confined areas.
- Use water spray to reduce vapors or divert vapor cloud drift. Avoid allowing water runoff to contact spilled material.
- Do not direct water at spill or source of leak.
- Isolate area until gas has dispersed.

FIRST AID

- Call 911 or emergency medical service.
- Ensure that medical personnel are aware of the material(s) involved and take precautions to protect themselves.
- Move victim to fresh air if it can be done safely.
- Give artificial respiration if victim is not breathing.
- **Do not perform mouth-to-mouth resuscitation if victim ingested or inhaled the substance; wash face and mouth before giving artificial respiration. Use a pocket mask equipped with a one-way valve or other proper respiratory medical device.**
- Administer oxygen if breathing is difficult.
- Remove and isolate contaminated clothing and shoes.
- In case of contact with liquefied gas, thaw frosted parts with lukewarm water.
- In case of contact with substance, immediately flush skin or eyes with running water for at least 20 minutes.
- Keep victim calm and warm.
- Keep victim under observation.
- Effects of contact or inhalation may be delayed.

GUIDE 124

GASES - TOXIC AND/OR CORROSIVE - OXIDIZING

POTENTIAL HAZARDS

HEALTH

- **TOXIC; may be fatal if inhaled or absorbed through skin.**
- Fire will produce irritating, corrosive and/or toxic gases.
- Contact with gas or liquefied gas may cause burns, severe injury and/or frostbite.
- Runoff from fire control or dilution water may cause environmental contamination.

FIRE OR EXPLOSION

- Substance does not burn but will support combustion.
- Vapors from liquefied gas are initially heavier than air and spread along ground.
- These are strong oxidizers and will react vigorously or explosively with many materials including fuels.
- May ignite combustibles (wood, paper, oil, clothing, etc.).
- Some will react violently with air, moist air and/or water.
- Cylinders exposed to fire may vent and release toxic and/or corrosive gas through pressure relief devices.
- Containers may explode when heated.
- Ruptured cylinders may rocket.

PUBLIC SAFETY

- **CALL 911. Then call emergency response telephone number on shipping paper.** If shipping paper not available or no answer, refer to appropriate telephone number listed on the inside back cover.
- Keep unauthorized personnel away.
- Stay upwind, uphill and/or upstream.
- Many gases are heavier than air and will spread along the ground and collect in low or confined areas (sewers, basements, tanks, etc.).
- Ventilate closed spaces before entering, but only if properly trained and equipped.

PROTECTIVE CLOTHING

- Wear positive pressure self-contained breathing apparatus (SCBA).
- Wear chemical protective clothing that is specifically recommended by the manufacturer **when there is NO RISK OF FIRE.**
- Structural firefighters' protective clothing provides thermal protection **but only limited chemical protection.**

EVACUATION

Immediate precautionary measure

- Isolate spill or leak area for at least 100 meters (330 feet) in all directions.

Spill

- See **Table 1 - Initial Isolation and Protective Action Distances.**

Fire

- If tank, rail car or tank truck is involved in a fire, ISOLATE for 800 meters (1/2 mile) in all directions; also, consider initial evacuation for 800 meters (1/2 mile) in all directions.



In Canada, an Emergency Response Assistance Plan (ERAP) may be required for this product. Please consult the shipping paper and/or the ERAP Program Section (page 390).

EMERGENCY RESPONSE

FIRE

Small Fire

CAUTION: These materials do not burn but will support combustion. Some will react violently with water.

- Contain fire and let burn. If fire must be fought, water spray or fog is recommended.
- **Water only; no dry chemical, CO₂ or Halon®.**
- Do not get water inside containers.
- If it can be done safely, move undamaged containers away from the area around the fire.
- Damaged cylinders should be handled only by specialists.

Fire Involving Tanks

- Fight fire from maximum distance or use unmanned master stream devices or monitor nozzles.
- Cool containers with flooding quantities of water until well after fire is out.
- Do not direct water at source of leak or safety devices; icing may occur.
- Withdraw immediately in case of rising sound from venting safety devices or discoloration of tank.
- ALWAYS stay away from tanks engulfed in fire.
- For massive fire, use unmanned master stream devices or monitor nozzles; if this is impossible, withdraw from area and let fire burn.

SPILL OR LEAK

- Do not touch or walk through spilled material.
- Keep combustibles (wood, paper, oil, etc.) away from spilled material.
- Stop leak if you can do it without risk.
- Use water spray to reduce vapors or divert vapor cloud drift. Avoid allowing water runoff to contact spilled material.
- Do not direct water at spill or source of leak.
- If possible, turn leaking containers so that gas escapes rather than liquid.
- Prevent entry into waterways, sewers, basements or confined areas.
- Isolate area until gas has dispersed.
- Ventilate the area.

FIRST AID

- Call 911 or emergency medical service.
- Ensure that medical personnel are aware of the material(s) involved and take precautions to protect themselves.
- Move victim to fresh air if it can be done safely.
- Give artificial respiration if victim is not breathing.
- **Do not perform mouth-to-mouth resuscitation if victim ingested or inhaled the substance; wash face and mouth before giving artificial respiration. Use a pocket mask equipped with a one-way valve or other proper respiratory medical device.**
- Administer oxygen if breathing is difficult.
- Clothing frozen to the skin should be thawed before being removed.
- Remove and isolate contaminated clothing and shoes.
- In case of contact with substance, immediately flush skin or eyes with running water for at least 20 minutes.
- Keep victim calm and warm.
- Keep victim under observation.
- Effects of contact or inhalation may be delayed.

GUIDE GASES - TOXIC AND/OR CORROSIVE 125

POTENTIAL HAZARDS

HEALTH

- **TOXIC; may be fatal if inhaled, ingested or absorbed through skin.**
- Vapors are extremely irritating and corrosive.
- Contact with gas or liquefied gas may cause burns, severe injury and/or frostbite.
- Fire will produce irritating, corrosive and/or toxic gases.
- Runoff from fire control or dilution water may cause environmental contamination.

FIRE OR EXPLOSION

- Some may burn but none ignite readily.
- Vapors from liquefied gas are initially heavier than air and spread along ground.
- Some of these materials may react violently with water.
- Cylinders exposed to fire may vent and release toxic and/or corrosive gas through pressure relief devices.
- Containers may explode when heated.
- Ruptured cylinders may rocket.
- For UN1005: Anhydrous ammonia, at high concentrations in confined spaces, presents a flammability risk if a source of ignition is introduced.

PUBLIC SAFETY

- **CALL 911. Then call emergency response telephone number on shipping paper.** If shipping paper not available or no answer, refer to appropriate telephone number listed on the inside back cover.
- Keep unauthorized personnel away.
- Stay upwind, uphill and/or upstream.
- Many gases are heavier than air and will spread along the ground and collect in low or confined areas (sewers, basements, tanks, etc.).
- Ventilate closed spaces before entering, but only if properly trained and equipped.

PROTECTIVE CLOTHING

- Wear positive pressure self-contained breathing apparatus (SCBA).
- Wear chemical protective clothing that is specifically recommended by the manufacturer **when there is NO RISK OF FIRE.**
- Structural firefighters' protective clothing provides thermal protection **but only limited chemical protection.**

EVACUATION

Immediate precautionary measure

- Isolate spill or leak area for at least 100 meters (330 feet) in all directions.

Spill

- For **highlighted materials**: see Table 1 - Initial Isolation and Protective Action Distances.
- For non-highlighted materials: increase the immediate precautionary measure distance, in the downwind direction, as necessary.

Fire

- If tank, rail car or tank truck is involved in a fire, ISOLATE for 1600 meters (1 mile) in all directions; also, consider initial evacuation for 1600 meters (1 mile) in all directions.



In Canada, an Emergency Response Assistance Plan (ERAP) may be required for this product. Please consult the shipping paper and/or the ERAP Program Section (page 390).

EMERGENCY RESPONSE

FIRE

Small Fire

- Dry chemical or CO₂.

Large Fire

- Water spray, fog or regular foam.
- If it can be done safely, move undamaged containers away from the area around the fire.
- Do not get water inside containers.
- Damaged cylinders should be handled only by specialists.

Fire Involving Tanks

- Fight fire from maximum distance or use unmanned master stream devices or monitor nozzles.
- Cool containers with flooding quantities of water until well after fire is out.
- Do not direct water at source of leak or safety devices; icing may occur.
- Withdraw immediately in case of rising sound from venting safety devices or discoloration of tank.
- ALWAYS stay away from tanks engulfed in fire.

SPILL OR LEAK

- Do not touch or walk through spilled material.
- Stop leak if you can do it without risk.
- If possible, turn leaking containers so that gas escapes rather than liquid.
- Prevent entry into waterways, sewers, basements or confined areas.
- Do not direct water at spill or source of leak.
- Use water spray to reduce vapors or divert vapor cloud drift. Avoid allowing water runoff to contact spilled material.
- Isolate area until gas has dispersed.

FIRST AID

- Call 911 or emergency medical service.
- Ensure that medical personnel are aware of the material(s) involved and take precautions to protect themselves.
- Move victim to fresh air if it can be done safely.
- Give artificial respiration if victim is not breathing.
- **Do not perform mouth-to-mouth resuscitation if victim ingested or inhaled the substance; wash face and mouth before giving artificial respiration. Use a pocket mask equipped with a one-way valve or other proper respiratory medical device.**
- Administer oxygen if breathing is difficult.
- Remove and isolate contaminated clothing and shoes.
- In case of contact with liquefied gas, thaw frosted parts with lukewarm water.
- In case of contact with substance, immediately flush skin or eyes with running water for at least 20 minutes.
- **In case of skin contact with hydrogen fluoride, anhydrous (UN1052)**, if calcium gluconate gel is available, rinse 5 minutes, then apply gel. Otherwise, continue rinsing until medical treatment is available.
- Keep victim calm and warm.
- Keep victim under observation.
- Effects of contact or inhalation may be delayed.

GUIDE 126 GASES - COMPRESSED OR LIQUEFIED (INCLUDING REFRIGERANT GASES)

POTENTIAL HAZARDS

FIRE OR EXPLOSION

- Some may burn but none ignite readily.
- Containers may explode when heated.
- Ruptured cylinders may rocket.

CAUTION: Aerosols (UN1950) may contain a flammable propellant.

HEALTH

- Vapors may cause dizziness or asphyxiation without warning.
- Vapors from liquefied gas are initially heavier than air and spread along ground.
- Contact with gas or liquefied gas may cause burns, severe injury and/or frostbite.
- Fire may produce irritating, corrosive and/or toxic gases.

PUBLIC SAFETY

- **CALL 911. Then call emergency response telephone number on shipping paper.** If shipping paper not available or no answer, refer to appropriate telephone number listed on the inside back cover.
- Keep unauthorized personnel away.
- Stay upwind, uphill and/or upstream.
- Many gases are heavier than air and will spread along the ground and collect in low or confined areas (sewers, basements, tanks, etc.).
- Ventilate closed spaces before entering, but only if properly trained and equipped.

PROTECTIVE CLOTHING

- Wear positive pressure self-contained breathing apparatus (SCBA).
- Wear chemical protective clothing that is specifically recommended by the manufacturer **when there is NO RISK OF FIRE.**
- Structural firefighters' protective clothing provides thermal protection **but only limited chemical protection.**

EVACUATION

Immediate precautionary measure

- Isolate spill or leak area for at least 100 meters (330 feet) in all directions.

Large Spill

- Consider initial downwind evacuation for at least 500 meters (1/3 mile).

Fire

- If tank, rail car or tank truck is involved in a fire, ISOLATE for 800 meters (1/2 mile) in all directions; also, consider initial evacuation for 800 meters (1/2 mile) in all directions.

EMERGENCY RESPONSE

FIRE

- Use extinguishing agent suitable for type of surrounding fire.

Small Fire

- Dry chemical or CO₂.

Large Fire

- Water spray, fog or regular foam.
- If it can be done safely, move undamaged containers away from the area around the fire.
- Damaged cylinders should be handled only by specialists.

Fire Involving Tanks

- Fight fire from maximum distance or use unmanned master stream devices or monitor nozzles.
- Cool containers with flooding quantities of water until well after fire is out.
- Do not direct water at source of leak or safety devices; icing may occur.
- Withdraw immediately in case of rising sound from venting safety devices or discoloration of tank.
- ALWAYS stay away from tanks engulfed in fire.
- Some of these materials, if spilled, may evaporate leaving a flammable residue.

SPILL OR LEAK

- Do not touch or walk through spilled material.
- Stop leak if you can do it without risk.
- Do not direct water at spill or source of leak.
- Use water spray to reduce vapors or divert vapor cloud drift. Avoid allowing water runoff to contact spilled material.
- If possible, turn leaking containers so that gas escapes rather than liquid.
- Prevent entry into waterways, sewers, basements or confined areas.
- Allow substance to evaporate.
- Ventilate the area.

FIRST AID

- Call 911 or emergency medical service.
- Ensure that medical personnel are aware of the material(s) involved and take precautions to protect themselves.
- Move victim to fresh air if it can be done safely.
- Give artificial respiration if victim is not breathing.
- Administer oxygen if breathing is difficult.
- Remove and isolate contaminated clothing and shoes.
- In case of contact with liquefied gas, thaw frosted parts with lukewarm water.
- Keep victim calm and warm.

GUIDE **FLAMMABLE LIQUIDS** 127 **(WATER-MISCIBLE)**

POTENTIAL HAZARDS

FIRE OR EXPLOSION

- **HIGHLY FLAMMABLE:** Will be easily ignited by heat, sparks or flames.

CAUTION: Ethanol (UN1170) can burn with an invisible flame. Use an alternate method of detection (thermal camera, broom handle, etc.)

- Vapors may form explosive mixtures with air.
- Vapors may travel to source of ignition and flash back.
- Most vapors are heavier than air. They will spread along the ground and collect in low or confined areas (sewers, basements, tanks, etc.).
- Vapor explosion hazard indoors, outdoors or in sewers.
- Those substances designated with a **(P)** may polymerize explosively when heated or involved in a fire.
- Runoff to sewer may create fire or explosion hazard.
- Containers may explode when heated.
- Many liquids will float on water.

HEALTH

- Inhalation or contact with material may irritate or burn skin and eyes.
- Fire may produce irritating, corrosive and/or toxic gases.
- Vapors may cause dizziness or asphyxiation.
- Runoff from fire control or dilution water may cause environmental contamination.

PUBLIC SAFETY

- **CALL 911. Then call emergency response telephone number on shipping paper.** If shipping paper not available or no answer, refer to appropriate telephone number listed on the inside back cover.
- Keep unauthorized personnel away.
- Stay upwind, uphill and/or upstream.
- Ventilate closed spaces before entering, but only if properly trained and equipped.

PROTECTIVE CLOTHING

- Wear positive pressure self-contained breathing apparatus (SCBA).
- Structural firefighters' protective clothing provides thermal protection **but only limited chemical protection.**

EVACUATION

Immediate precautionary measure

- Isolate spill or leak area for at least 50 meters (150 feet) in all directions.

Large Spill

- Consider initial downwind evacuation for at least 300 meters (1000 feet).

Fire

- If tank, rail car or tank truck is involved in a fire, ISOLATE for 800 meters (1/2 mile) in all directions; also, consider initial evacuation for 800 meters (1/2 mile) in all directions.



In Canada, an Emergency Response Assistance Plan (ERAP) may be required for this product. Please consult the shipping paper and/or the ERAP Program Section (page 390).

EMERGENCY RESPONSE

FIRE

CAUTION: The majority of these products have a very low flash point. Use of water spray when fighting fire may be inefficient.

CAUTION: For fire involving UN1170, UN1987 or UN3475, alcohol-resistant foam should be used.

CAUTION: Ethanol (UN1170) can burn with an invisible flame. Use an alternate method of detection (thermal camera, broom handle, etc.)

Small Fire

- Dry chemical, CO₂, water spray or alcohol-resistant foam.

Large Fire

- Water spray, fog or alcohol-resistant foam.
- Avoid aiming straight or solid streams directly onto the product.
- If it can be done safely, move undamaged containers away from the area around the fire.

Fire Involving Tanks or Car/Trailer Loads

- Fight fire from maximum distance or use unmanned master stream devices or monitor nozzles.
- Cool containers with flooding quantities of water until well after fire is out.
- Withdraw immediately in case of rising sound from venting safety devices or discoloration of tank.
- ALWAYS stay away from tanks engulfed in fire.
- For massive fire, use unmanned master stream devices or monitor nozzles; if this is impossible, withdraw from area and let fire burn.

SPILL OR LEAK

- ELIMINATE all ignition sources (no smoking, flares, sparks or flames) from immediate area.
- All equipment used when handling the product must be grounded.
- Do not touch or walk through spilled material.
- Stop leak if you can do it without risk.
- Prevent entry into waterways, sewers, basements or confined areas.
- A vapor-suppressing foam may be used to reduce vapors.
- Absorb or cover with dry earth, sand or other non-combustible material and transfer to containers.
- Use clean, non-sparking tools to collect absorbed material.

Large Spill

- Dike far ahead of liquid spill for later disposal.
- Water spray may reduce vapor, but may not prevent ignition in closed spaces.

FIRST AID

- Call 911 or emergency medical service.
- Ensure that medical personnel are aware of the material(s) involved and take precautions to protect themselves.
- Move victim to fresh air if it can be done safely.
- Give artificial respiration if victim is not breathing.
- Administer oxygen if breathing is difficult.
- Remove and isolate contaminated clothing and shoes.
- In case of contact with substance, immediately flush skin or eyes with running water for at least 20 minutes.
- Wash skin with soap and water.
- In case of burns, immediately cool affected skin for as long as possible with cold water. Do not remove clothing if adhering to skin.
- Keep victim calm and warm.

POTENTIAL HAZARDS

FIRE OR EXPLOSION

- **HIGHLY FLAMMABLE: Will be easily ignited by heat, sparks or flames.**
- Vapors may form explosive mixtures with air.
- Vapors may travel to source of ignition and flash back.
- Most vapors are heavier than air. They will spread along the ground and collect in low or confined areas (sewers, basements, tanks, etc.).
- Vapor explosion hazard indoors, outdoors or in sewers.
- Those substances designated with a (P) may polymerize explosively when heated or involved in a fire.
- Runoff to sewer may create fire or explosion hazard.
- Containers may explode when heated.
- Many liquids will float on water.
- Substance may be transported hot.
- For hybrid vehicles, GUIDE 147 (lithium ion batteries) or GUIDE 138 (sodium batteries) should also be consulted.
- **If molten aluminum is involved, refer to GUIDE 169.**

HEALTH

CAUTION: Petroleum crude oil (UN1267) may contain **TOXIC** hydrogen sulphide gas.

- Inhalation or contact with material may irritate or burn skin and eyes.
- Fire may produce irritating, corrosive and/or toxic gases.
- Vapors may cause dizziness or asphyxiation.
- Runoff from fire control or dilution water may cause environmental contamination.

PUBLIC SAFETY

- **CALL 911. Then call emergency response telephone number on shipping paper.** If shipping paper not available or no answer, refer to appropriate telephone number listed on the inside back cover.
- Keep unauthorized personnel away.
- Stay upwind, uphill and/or upstream.
- Ventilate closed spaces before entering, but only if properly trained and equipped.

PROTECTIVE CLOTHING

- Wear positive pressure self-contained breathing apparatus (SCBA).
- Structural firefighters' protective clothing provides thermal protection **but only limited chemical protection.**

EVACUATION

Immediate precautionary measure

- Isolate spill or leak area for at least 50 meters (150 feet) in all directions.

Large Spill

- Consider initial downwind evacuation for at least 300 meters (1000 feet).

Fire

- If tank, rail car or tank truck is involved in a fire, ISOLATE for 800 meters (1/2 mile) in all directions; also, consider initial evacuation for 800 meters (1/2 mile) in all directions.



In Canada, an Emergency Response Assistance Plan (ERAP) may be required for this product. Please consult the shipping paper and/or the ERAP Program Section (page 390).

EMERGENCY RESPONSE

FIRE

CAUTION: The majority of these products have a very low flash point. Use of water spray when fighting fire may be inefficient.

CAUTION: For mixtures containing alcohol or polar solvent, alcohol-resistant foam may be more effective.

Small Fire

- Dry chemical, CO₂, water spray or regular foam.

Large Fire

- Water spray, fog or regular foam.
- Avoid aiming straight or solid streams directly onto the product.
- If it can be done safely, move undamaged containers away from the area around the fire.

Fire Involving Tanks or Car/Trailer Loads

- Fight fire from maximum distance or use unmanned master stream devices or monitor nozzles.
- Cool containers with flooding quantities of water until well after fire is out.
- For petroleum crude oil, do not spray water directly into a breached tank car. This can lead to a dangerous boil over.
- Withdraw immediately in case of rising sound from venting safety devices or discoloration of tank.
- ALWAYS stay away from tanks engulfed in fire.
- For massive fire, use unmanned master stream devices or monitor nozzles; if this is impossible, withdraw from area and let fire burn.

SPILL OR LEAK

- ELIMINATE all ignition sources (no smoking, flares, sparks or flames) from immediate area.
- All equipment used when handling the product must be grounded.
- Do not touch or walk through spilled material.
- Stop leak if you can do it without risk.
- Prevent entry into waterways, sewers, basements or confined areas.
- A vapor-suppressing foam may be used to reduce vapors.
- Absorb or cover with dry earth, sand or other non-combustible material and transfer to containers.
- Use clean, non-sparking tools to collect absorbed material.

Large Spill

- Dike far ahead of liquid spill for later disposal.
- Water spray may reduce vapor, but may not prevent ignition in closed spaces.

FIRST AID

- Call 911 or emergency medical service.
- Ensure that medical personnel are aware of the material(s) involved and take precautions to protect themselves.
- Move victim to fresh air if it can be done safely.
- Give artificial respiration if victim is not breathing.
- Administer oxygen if breathing is difficult.
- Remove and isolate contaminated clothing and shoes.
- In case of contact with substance, immediately flush skin or eyes with running water for at least 20 minutes.
- Wash skin with soap and water.
- In case of burns, immediately cool affected skin for as long as possible with cold water. Do not remove clothing if adhering to skin.
- Keep victim calm and warm.

GUIDE 129

FLAMMABLE LIQUIDS (WATER-MISCIBLE/NOXIOUS)

POTENTIAL HAZARDS

FIRE OR EXPLOSION

- **HIGHLY FLAMMABLE: Will be easily ignited by heat, sparks or flames.**
- Vapors may form explosive mixtures with air.
- Vapors may travel to source of ignition and flash back.
- Most vapors are heavier than air. They will spread along the ground and collect in low or confined areas (sewers, basements, tanks, etc.).
- Vapor explosion hazard indoors, outdoors or in sewers.
- Those substances designated with a (P) may polymerize explosively when heated or involved in a fire.
- Runoff to sewer may create fire or explosion hazard.
- Containers may explode when heated.
- Many liquids will float on water.

HEALTH

- May cause toxic effects if inhaled or absorbed through skin.
- Inhalation or contact with material may irritate or burn skin and eyes.
- Fire will produce irritating, corrosive and/or toxic gases.
- Vapors may cause dizziness or asphyxiation.
- Runoff from fire control or dilution water may cause environmental contamination.

PUBLIC SAFETY

- **CALL 911. Then call emergency response telephone number on shipping paper.** If shipping paper not available or no answer, refer to appropriate telephone number listed on the inside back cover.
- Keep unauthorized personnel away.
- Stay upwind, uphill and/or upstream.
- Ventilate closed spaces before entering, but only if properly trained and equipped.

PROTECTIVE CLOTHING

- Wear positive pressure self-contained breathing apparatus (SCBA).
- Structural firefighters' protective clothing provides thermal protection **but only limited chemical protection.**

EVACUATION

Immediate precautionary measure

- Isolate spill or leak area for at least 50 meters (150 feet) in all directions.

Large Spill

- Consider initial downwind evacuation for at least 300 meters (1000 feet).

Fire

- If tank, rail car or tank truck is involved in a fire, ISOLATE for 800 meters (1/2 mile) in all directions; also, consider initial evacuation for 800 meters (1/2 mile) in all directions.



In Canada, an Emergency Response Assistance Plan (ERAP) may be required for this product. Please consult the shipping paper and/or the ERAP Program Section (page 390).

EMERGENCY RESPONSE

FIRE

CAUTION: The majority of these products have a very low flash point. Use of water spray when fighting fire may be inefficient.

Small Fire

- Dry chemical, CO₂, water spray or alcohol-resistant foam.
- **Do not use dry chemical extinguishers to control fires involving nitromethane (UN1261) or nitroethane (UN2842).**

Large Fire

- Water spray, fog or alcohol-resistant foam.
- Avoid aiming straight or solid streams directly onto the product.
- If it can be done safely, move undamaged containers away from the area around the fire.

Fire Involving Tanks or Car/Trailer Loads

- Fight fire from maximum distance or use unmanned master stream devices or monitor nozzles.
- Cool containers with flooding quantities of water until well after fire is out.
- Withdraw immediately in case of rising sound from venting safety devices or discoloration of tank.
- ALWAYS stay away from tanks engulfed in fire.
- For massive fire, use unmanned master stream devices or monitor nozzles; if this is impossible, withdraw from area and let fire burn.

SPILL OR LEAK

- ELIMINATE all ignition sources (no smoking, flares, sparks or flames) from immediate area.
- All equipment used when handling the product must be grounded.
- Do not touch or walk through spilled material.
- Stop leak if you can do it without risk.
- Prevent entry into waterways, sewers, basements or confined areas.
- A vapor-suppressing foam may be used to reduce vapors.
- Absorb or cover with dry earth, sand or other non-combustible material and transfer to containers.
- Use clean, non-sparking tools to collect absorbed material.

Large Spill

- Dike far ahead of liquid spill for later disposal.
- Water spray may reduce vapor, but may not prevent ignition in closed spaces.

FIRST AID

- Call 911 or emergency medical service.
- Ensure that medical personnel are aware of the material(s) involved and take precautions to protect themselves.
- Move victim to fresh air if it can be done safely.
- Give artificial respiration if victim is not breathing.
- Administer oxygen if breathing is difficult.
- Remove and isolate contaminated clothing and shoes.
- In case of contact with substance, immediately flush skin or eyes with running water for at least 20 minutes.
- Wash skin with soap and water.
- In case of burns, immediately cool affected skin for as long as possible with cold water. Do not remove clothing if adhering to skin.
- Keep victim calm and warm.
- Effects of exposure (inhalation, ingestion or skin contact) to substance may be delayed.

GUIDE 130 FLAMMABLE LIQUIDS (WATER-IMMISCIBLE/NOXIOUS)

POTENTIAL HAZARDS

FIRE OR EXPLOSION

- **HIGHLY FLAMMABLE: Will be easily ignited by heat, sparks or flames.**
- Vapors may form explosive mixtures with air.
- Vapors may travel to source of ignition and flash back.
- Most vapors are heavier than air. They will spread along the ground and collect in low or confined areas (sewers, basements, tanks, etc.).
- Vapor explosion hazard indoors, outdoors or in sewers.
- Those substances designated with a (P) may polymerize explosively when heated or involved in a fire.
- Runoff to sewer may create fire or explosion hazard.
- Containers may explode when heated.
- Many liquids will float on water.

HEALTH

- May cause toxic effects if inhaled or absorbed through skin.
- Inhalation or contact with material may irritate or burn skin and eyes.
- Fire will produce irritating, corrosive and/or toxic gases.
- Vapors may cause dizziness or asphyxiation.
- Runoff from fire control or dilution water may cause environmental contamination.

PUBLIC SAFETY

- **CALL 911. Then call emergency response telephone number on shipping paper.** If shipping paper not available or no answer, refer to appropriate telephone number listed on the inside back cover.
- Keep unauthorized personnel away.
- Stay upwind, uphill and/or upstream.
- Ventilate closed spaces before entering, but only if properly trained and equipped.

PROTECTIVE CLOTHING

- Wear positive pressure self-contained breathing apparatus (SCBA).
- Structural firefighters' protective clothing provides thermal protection **but only limited chemical protection.**

EVACUATION

Immediate precautionary measure

- Isolate spill or leak area for at least 50 meters (150 feet) in all directions.

Large Spill

- Consider initial downwind evacuation for at least 300 meters (1000 feet).

Fire

- If tank, rail car or tank truck is involved in a fire, ISOLATE for 800 meters (1/2 mile) in all directions; also, consider initial evacuation for 800 meters (1/2 mile) in all directions.

EMERGENCY RESPONSE

FIRE

CAUTION: The majority of these products have a very low flash point. Use of water spray when fighting fire may be inefficient.

Small Fire

- Dry chemical, CO₂, water spray or regular foam.

Large Fire

- Water spray, fog or regular foam.
- Avoid aiming straight or solid streams directly onto the product.
- If it can be done safely, move undamaged containers away from the area around the fire.

Fire Involving Tanks or Car/Trailer Loads

- Fight fire from maximum distance or use unmanned master stream devices or monitor nozzles.
- Cool containers with flooding quantities of water until well after fire is out.
- Withdraw immediately in case of rising sound from venting safety devices or discoloration of tank.
- ALWAYS stay away from tanks engulfed in fire.
- For massive fire, use unmanned master stream devices or monitor nozzles; if this is impossible, withdraw from area and let fire burn.

SPILL OR LEAK

- ELIMINATE all ignition sources (no smoking, flares, sparks or flames) from immediate area.
- All equipment used when handling the product must be grounded.
- Do not touch or walk through spilled material.
- Stop leak if you can do it without risk.
- Prevent entry into waterways, sewers, basements or confined areas.
- A vapor-suppressing foam may be used to reduce vapors.
- Absorb or cover with dry earth, sand or other non-combustible material and transfer to containers.
- Use clean, non-sparking tools to collect absorbed material.

Large Spill

- Dike far ahead of liquid spill for later disposal.
- Water spray may reduce vapor, but may not prevent ignition in closed spaces.

FIRST AID

- Call 911 or emergency medical service.
- Ensure that medical personnel are aware of the material(s) involved and take precautions to protect themselves.
- Move victim to fresh air if it can be done safely.
- Give artificial respiration if victim is not breathing.
- Administer oxygen if breathing is difficult.
- Remove and isolate contaminated clothing and shoes.
- In case of contact with substance, immediately flush skin or eyes with running water for at least 20 minutes.
- Wash skin with soap and water.
- In case of burns, immediately cool affected skin for as long as possible with cold water. Do not remove clothing if adhering to skin.
- Keep victim calm and warm.
- Effects of exposure (inhalation, ingestion or skin contact) to substance may be delayed.

GUIDE FLAMMABLE LIQUIDS - TOXIC

131

POTENTIAL HAZARDS

HEALTH

- **TOXIC; may be fatal if inhaled, ingested or absorbed through skin.**
- Inhalation or contact with some of these materials will irritate or burn skin and eyes.
- Fire will produce irritating, corrosive and/or toxic gases.
- Vapors may cause dizziness or asphyxiation.
- Runoff from fire control or dilution water may cause environmental contamination.

FIRE OR EXPLOSION

- **HIGHLY FLAMMABLE: Will be easily ignited by heat, sparks or flames.**
- **CAUTION: Methanol (UN1230) will burn with an invisible flame. Use an alternate method of detection (thermal camera, broom handle, etc.)**
- Vapors may form explosive mixtures with air.
- Vapors may travel to source of ignition and flash back.
- Most vapors are heavier than air. They will spread along the ground and collect in low or confined areas (sewers, basements, tanks, etc.).
- Vapor explosion and poison hazard indoors, outdoors or in sewers.
- Those substances designated with a (P) may polymerize explosively when heated or involved in a fire.
- Runoff to sewer may create fire or explosion hazard.
- Containers may explode when heated.
- Many liquids will float on water.

PUBLIC SAFETY

- **CALL 911. Then call emergency response telephone number on shipping paper.** If shipping paper not available or no answer, refer to appropriate telephone number listed on the inside back cover.
- Keep unauthorized personnel away.
- Stay upwind, uphill and/or upstream.
- Ventilate closed spaces before entering, but only if properly trained and equipped.

PROTECTIVE CLOTHING

- Wear positive pressure self-contained breathing apparatus (SCBA).
- Wear chemical protective clothing that is specifically recommended by the manufacturer **when there is NO RISK OF FIRE.**
- Structural firefighters' protective clothing provides thermal protection **but only limited chemical protection.**

EVACUATION

Immediate precautionary measure

- Isolate spill or leak area for at least 50 meters (150 feet) in all directions.

Spill

- For **highlighted materials**: see Table 1 - Initial Isolation and Protective Action Distances.
- For non-highlighted materials: increase the immediate precautionary measure distance, in the downwind direction, as necessary.

Fire

- If tank, rail car or tank truck is involved in a fire, ISOLATE for 800 meters (1/2 mile) in all directions; also, consider initial evacuation for 800 meters (1/2 mile) in all directions.



In Canada, an Emergency Response Assistance Plan (ERAP) may be required for this product. Please consult the shipping paper and/or the ERAP Program Section (page 390).

EMERGENCY RESPONSE

FIRE

CAUTION: The majority of these products have a very low flash point. Use of water spray when fighting fire may be inefficient.

CAUTION: Methanol (UN1230) will burn with an invisible flame. Use an alternate method of detection (thermal camera, broom handle, etc.)

Small Fire

- Dry chemical, CO₂, water spray or alcohol-resistant foam.

Large Fire

- Water spray, fog or alcohol-resistant foam.
- If it can be done safely, move undamaged containers away from the area around the fire.
- Dike runoff from fire control for later disposal.
- Avoid aiming straight or solid streams directly onto the product.

Fire Involving Tanks or Car/Trailer Loads

- Fight fire from maximum distance or use unmanned master stream devices or monitor nozzles.
- Cool containers with flooding quantities of water until well after fire is out.
- Withdraw immediately in case of rising sound from venting safety devices or discoloration of tank.
- ALWAYS stay away from tanks engulfed in fire.
- For massive fire, use unmanned master stream devices or monitor nozzles; if this is impossible, withdraw from area and let fire burn.

SPILL OR LEAK

- ELIMINATE all ignition sources (no smoking, flares, sparks or flames) from immediate area.
- All equipment used when handling the product must be grounded.
- Do not touch or walk through spilled material.
- Stop leak if you can do it without risk.
- Prevent entry into waterways, sewers, basements or confined areas.
- A vapor-suppressing foam may be used to reduce vapors.

Small Spill

- Absorb with earth, sand or other non-combustible material and transfer to containers for later disposal.
- Use clean, non-sparking tools to collect absorbed material.

Large Spill

- Dike far ahead of liquid spill for later disposal.
- Water spray may reduce vapor, but may not prevent ignition in closed spaces.

FIRST AID

- Call 911 or emergency medical service.
- Ensure that medical personnel are aware of the material(s) involved and take precautions to protect themselves.
 - Move victim to fresh air if it can be done safely.
- Give artificial respiration if victim is not breathing.
- **Do not perform mouth-to-mouth resuscitation if victim ingested or inhaled the substance; wash face and mouth before giving artificial respiration. Use a pocket mask equipped with a one-way valve or other proper respiratory medical device.**
- Administer oxygen if breathing is difficult.
- Remove and isolate contaminated clothing and shoes.
- In case of contact with substance, immediately flush skin or eyes with running water for at least 20 minutes.
- Wash skin with soap and water.
- In case of burns, immediately cool affected skin for as long as possible with cold water. Do not remove clothing if adhering to skin.
 - Keep victim calm and warm.
- Effects of exposure (inhalation, ingestion or skin contact) to substance may be delayed.

GUIDE FLAMMABLE LIQUIDS - CORROSIVE

132

POTENTIAL HAZARDS

FIRE OR EXPLOSION

- Flammable/combustible material.
- May be ignited by heat, sparks or flames.
- Vapors may form explosive mixtures with air.
- Vapors may travel to source of ignition and flash back.
- Most vapors are heavier than air. They will spread along the ground and collect in low or confined areas (sewers, basements, tanks, etc.).
- Vapor explosion hazard indoors, outdoors or in sewers.
- Those substances designated with a **(P)** may polymerize explosively when heated or involved in a fire.
- Runoff to sewer may create fire or explosion hazard.
- Containers may explode when heated.
- Many liquids will float on water.

HEALTH

- May cause toxic effects if inhaled or ingested.
- Contact with substance may cause severe burns to skin and eyes.
- Fire will produce irritating, corrosive and/or toxic gases.
- Vapors may cause dizziness or asphyxiation.
- Runoff from fire control or dilution water may cause environmental contamination.

PUBLIC SAFETY

- **CALL 911. Then call emergency response telephone number on shipping paper.** If shipping paper not available or no answer, refer to appropriate telephone number listed on the inside back cover.
- Keep unauthorized personnel away.
- Stay upwind, uphill and/or upstream.
- Ventilate closed spaces before entering, but only if properly trained and equipped.

PROTECTIVE CLOTHING

- Wear positive pressure self-contained breathing apparatus (SCBA).
- Wear chemical protective clothing that is specifically recommended by the manufacturer **when there is NO RISK OF FIRE.**
- Structural firefighters' protective clothing provides thermal protection **but only limited chemical protection.**

EVACUATION

Immediate precautionary measure

- Isolate spill or leak area for at least 50 meters (150 feet) in all directions.

Spill

- For **highlighted materials**: see Table 1 - Initial Isolation and Protective Action Distances.
- For non-highlighted materials: increase the immediate precautionary measure distance, in the downwind direction, as necessary.

Fire

- If tank, rail car or tank truck is involved in a fire, ISOLATE for 800 meters (1/2 mile) in all directions; also, consider initial evacuation for 800 meters (1/2 mile) in all directions.



In Canada, an Emergency Response Assistance Plan (ERAP) may be required for this product. Please consult the shipping paper and/or the ERAP Program Section (page 390).

EMERGENCY RESPONSE

FIRE

- **Some of these materials may react violently with water.**

Small Fire

- Dry chemical, CO₂, water spray or alcohol-resistant foam.

Large Fire

- Water spray, fog or alcohol-resistant foam.
- If it can be done safely, move undamaged containers away from the area around the fire.
- Dike runoff from fire control for later disposal.
- Do not get water inside containers.

Fire Involving Tanks or Car/Trailer Loads

- Fight fire from maximum distance or use unmanned master stream devices or monitor nozzles.
- Cool containers with flooding quantities of water until well after fire is out.
- Withdraw immediately in case of rising sound from venting safety devices or discoloration of tank.
- ALWAYS stay away from tanks engulfed in fire.
- For massive fire, use unmanned master stream devices or monitor nozzles; if this is impossible, withdraw from area and let fire burn.

SPILL OR LEAK

- ELIMINATE all ignition sources (no smoking, flares, sparks or flames) from immediate area.
- All equipment used when handling the product must be grounded.
- Do not touch or walk through spilled material.
- Stop leak if you can do it without risk.
- Prevent entry into waterways, sewers, basements or confined areas.
- A vapor-suppressing foam may be used to reduce vapors.
- Absorb with earth, sand or other non-combustible material.
- For **hydrazine**, absorb with DRY sand or inert absorbent (vermiculite or absorbent pads).
- Use clean, non-sparking tools to collect absorbed material.

Large Spill

- Dike far ahead of liquid spill for later disposal.
- Water spray may reduce vapor, but may not prevent ignition in closed spaces.

FIRST AID

- Call 911 or emergency medical service.
- Ensure that medical personnel are aware of the material(s) involved and take precautions to protect themselves.
- Move victim to fresh air if it can be done safely.
- Give artificial respiration if victim is not breathing.
- **Do not perform mouth-to-mouth resuscitation if victim ingested or inhaled the substance; wash face and mouth before giving artificial respiration. Use a pocket mask equipped with a one-way valve or other proper respiratory medical device.**
- Administer oxygen if breathing is difficult.
- Remove and isolate contaminated clothing and shoes.
- In case of contact with substance, immediately flush skin or eyes with running water for at least 20 minutes.
- In case of burns, immediately cool affected skin for as long as possible with cold water. Do not remove clothing if adhering to skin.
- Keep victim calm and warm.
- Effects of exposure (inhalation, ingestion or skin contact) to substance may be delayed.

POTENTIAL HAZARDS

FIRE OR EXPLOSION

- Flammable/combustible material.
- May be ignited by friction, heat, sparks or flames.
- Some may burn rapidly with flare-burning effect.
- Powders, dusts, shavings, borings, turnings or cuttings may explode or burn with explosive violence.
- Substance may be transported in a molten form at a temperature that may be above its flash point.
- May re-ignite after fire is extinguished.

HEALTH

- Fire may produce irritating and/or toxic gases.
- Contact may cause burns to skin and eyes.
- Contact with molten substance may cause severe burns to skin and eyes.
- Runoff from fire control or dilution water may cause environmental contamination.

PUBLIC SAFETY

- **CALL 911. Then call emergency response telephone number on shipping paper.** If shipping paper not available or no answer, refer to appropriate telephone number listed on the inside back cover.
- Keep unauthorized personnel away.
- Stay upwind, uphill and/or upstream.

PROTECTIVE CLOTHING

- Wear positive pressure self-contained breathing apparatus (SCBA).
- Structural firefighters' protective clothing provides thermal protection **but only limited chemical protection.**

EVACUATION

Immediate precautionary measure

- Isolate spill or leak area for at least 25 meters (75 feet) in all directions.

Large Spill

- Consider initial downwind evacuation for at least 100 meters (330 feet).

Fire

- If tank, rail car or tank truck is involved in a fire, ISOLATE for 800 meters (1/2 mile) in all directions; also, consider initial evacuation for 800 meters (1/2 mile) in all directions.



In Canada, an Emergency Response Assistance Plan (ERAP) may be required for this product. Please consult the shipping paper and/or the ERAP Program Section (page 390).

EMERGENCY RESPONSE

FIRE

Small Fire

- Dry chemical, CO₂, sand, earth, water spray or regular foam.

Large Fire

- Water spray, fog or regular foam.
- If it can be done safely, move undamaged containers away from the area around the fire.

Fire Involving Metal Pigments or Pastes (e.g. "Aluminum Paste")

- Aluminum Paste fires should be treated as a combustible metal fire. Use DRY sand, graphite powder, dry sodium chloride-based extinguishers or class D extinguishers. Also, see GUIDE 170.

Fire Involving Tanks or Car/Trailer Loads

- Cool containers with flooding quantities of water until well after fire is out.
- For massive fire, use unmanned master stream devices or monitor nozzles; if this is impossible, withdraw from area and let fire burn.
- Withdraw immediately in case of rising sound from venting safety devices or discoloration of tank.
- ALWAYS stay away from tanks engulfed in fire.

SPILL OR LEAK

- ELIMINATE all ignition sources (no smoking, flares, sparks or flames) from immediate area.
- Do not touch or walk through spilled material.

Small Dry Spill

- With clean shovel, place material into clean, dry container and cover loosely; move containers from spill area.

Large Spill

- Wet down with water and dike for later disposal.
- Prevent entry into waterways, sewers, basements or confined areas.

FIRST AID

- Call 911 or emergency medical service.
- Ensure that medical personnel are aware of the material(s) involved and take precautions to protect themselves.
- Move victim to fresh air if it can be done safely.
- Give artificial respiration if victim is not breathing.
- Administer oxygen if breathing is difficult.
- Remove and isolate contaminated clothing and shoes.
- In case of contact with substance, immediately flush skin or eyes with running water for at least 20 minutes.
- Removal of solidified molten material from skin requires medical assistance.
- Keep victim calm and warm.

GUIDE 134

FLAMMABLE SOLIDS - TOXIC AND/OR CORROSIVE

POTENTIAL HAZARDS

FIRE OR EXPLOSION

- Flammable/combustible material.
- May be ignited by heat, sparks or flames.
- When heated, vapors may form explosive mixtures with air: indoors, outdoors and sewers explosion hazards.
- Contact with metals may evolve flammable hydrogen gas.
- Containers may explode when heated.

HEALTH

- **TOXIC;** inhalation, ingestion or skin contact with material may cause severe injury or death.
- Fire will produce irritating, corrosive and/or toxic gases.
- Runoff from fire control or dilution water may be corrosive and/or toxic and cause environmental contamination.

PUBLIC SAFETY

- **CALL 911. Then call emergency response telephone number on shipping paper.** If shipping paper not available or no answer, refer to appropriate telephone number listed on the inside back cover.
- Stay upwind, uphill and/or upstream.
- Keep unauthorized personnel away.
- Ventilate closed spaces before entering, but only if properly trained and equipped.

PROTECTIVE CLOTHING

- Wear positive pressure self-contained breathing apparatus (SCBA).
- Wear chemical protective clothing that is specifically recommended by the manufacturer **when there is NO RISK OF FIRE.**
- Structural firefighters' protective clothing provides thermal protection **but only limited chemical protection.**

EVACUATION

Immediate precautionary measure

- Isolate spill or leak area for at least 25 meters (75 feet) in all directions.

Large Spill

- Consider initial downwind evacuation for at least 100 meters (330 feet).

Fire

- If tank, rail car or tank truck is involved in a fire, ISOLATE for 800 meters (1/2 mile) in all directions; also, consider initial evacuation for 800 meters (1/2 mile) in all directions.



In Canada, an Emergency Response Assistance Plan (ERAP) may be required for this product. Please consult the shipping paper and/or the ERAP Program Section (page 390).

EMERGENCY RESPONSE

FIRE

Small Fire

- Dry chemical, CO₂, water spray or alcohol-resistant foam.

Large Fire

- Water spray, fog or alcohol-resistant foam.
- If it can be done safely, move undamaged containers away from the area around the fire.
- Avoid aiming straight or solid streams directly onto the product.
- Do not get water inside containers.
- Dike runoff from fire control for later disposal.

Fire Involving Tanks or Car/Trailer Loads

- Fight fire from maximum distance or use unmanned master stream devices or monitor nozzles.
- Cool containers with flooding quantities of water until well after fire is out.
- Withdraw immediately in case of rising sound from venting safety devices or discoloration of tank.
- ALWAYS stay away from tanks engulfed in fire.

SPILL OR LEAK

- ELIMINATE all ignition sources (no smoking, flares, sparks or flames) from immediate area.
- Stop leak if you can do it without risk.
- Do not touch damaged containers or spilled material unless wearing appropriate protective clothing.
- Prevent entry into waterways, sewers, basements or confined areas.
- Use clean, non-sparking tools to collect material and place it into loosely covered plastic containers for later disposal.

FIRST AID

- Call 911 or emergency medical service.
- Ensure that medical personnel are aware of the material(s) involved and take precautions to protect themselves.
- Move victim to fresh air if it can be done safely.
- Give artificial respiration if victim is not breathing.
- **Do not perform mouth-to-mouth resuscitation if victim ingested or inhaled the substance; wash face and mouth before giving artificial respiration. Use a pocket mask equipped with a one-way valve or other proper respiratory medical device.**
- Administer oxygen if breathing is difficult.
- Remove and isolate contaminated clothing and shoes.
- In case of contact with substance, immediately flush skin or eyes with running water for at least 20 minutes.
- For minor skin contact, avoid spreading material on unaffected skin.
- Keep victim calm and warm.
- Effects of exposure (inhalation, ingestion or skin contact) to substance may be delayed.

GUIDE SUBSTANCES - SPONTANEOUSLY COMBUSTIBLE

135

POTENTIAL HAZARDS

FIRE OR EXPLOSION

- Flammable/combustible material.
- May ignite on contact with moist air or moisture.
- May burn rapidly with flare-burning effect.
- Some react vigorously or explosively on contact with water.
- Some may decompose explosively when heated or involved in a fire.
- May re-ignite after fire is extinguished.
- Runoff may create fire or explosion hazard.
- Containers may explode when heated.

HEALTH

- Fire will produce irritating, corrosive and/or toxic gases.
- Inhalation of decomposition products may cause severe injury or death.
- Contact with substance may cause severe burns to skin and eyes.
- Runoff from fire control or dilution water may cause environmental contamination.

CAUTION: Pentaborane (UN1380) is highly toxic and may be fatal if inhaled, ingested or absorbed through skin.

PUBLIC SAFETY

- **CALL 911. Then call emergency response telephone number on shipping paper.** If shipping paper not available or no answer, refer to appropriate telephone number listed on the inside back cover.
- Stay upwind, uphill and/or upstream.
- Keep unauthorized personnel away.

PROTECTIVE CLOTHING

- Wear positive pressure self-contained breathing apparatus (SCBA).
- Wear chemical protective clothing that is specifically recommended by the manufacturer **when there is NO RISK OF FIRE.**
- Structural firefighters' protective clothing provides thermal protection **but only limited chemical protection.**

EVACUATION

Immediate precautionary measure

- Isolate spill or leak area in all directions for at least 50 meters (150 feet) for liquids and at least 25 meters (75 feet) for solids.

Spill

- For **highlighted materials**: see Table 1 - Initial Isolation and Protective Action Distances.
- For non-highlighted materials: increase the immediate precautionary measure distance, in the downwind direction, as necessary.

Fire

- If tank, rail car or tank truck is involved in a fire, ISOLATE for 800 meters (1/2 mile) in all directions; also, consider initial evacuation for 800 meters (1/2 mile) in all directions.



In Canada, an Emergency Response Assistance Plan (ERAP) may be required for this product. Please consult the shipping paper and/or the ERAP Program Section (page 390).

EMERGENCY RESPONSE

FIRE

- DO NOT USE WATER, CO₂ OR FOAM ON MATERIAL ITSELF.
- Some of these materials may react violently with water.

CAUTION: For Xanthates, UN3342 and for Dithionite (Hydrosulfite/Hydrosulphite) UN1384, UN1923 and UN1929, USE FLOODING AMOUNTS OF WATER for SMALL AND LARGE fires to stop the reaction. Smothering will not work for these materials, they do not need air to burn.

Small Fire

- Dry chemical, soda ash, lime or DRY sand, EXCEPT for UN1384, UN1923, UN1929 and UN3342.

Large Fire

- DRY sand, dry chemical, soda ash or lime EXCEPT for UN1384, UN1923, UN1929 and UN3342, or withdraw from area and let fire burn.

CAUTION: UN3342 when flooded with water will continue to evolve flammable Carbon disulfide/Carbon disulphide vapors.

- If it can be done safely, move undamaged containers away from the area around the fire.

Fire Involving Tanks or Car/Trailer Loads

- Fight fire from maximum distance or use unmanned master stream devices or monitor nozzles.
- Do not get water inside containers or in contact with substance.
- Cool containers with flooding quantities of water until well after fire is out.
- Withdraw immediately in case of rising sound from venting safety devices or discoloration of tank.
- ALWAYS stay away from tanks engulfed in fire.

SPILL OR LEAK

- ELIMINATE all ignition sources (no smoking, flares, sparks or flames) from immediate area.
- Do not touch or walk through spilled material.
- Stop leak if you can do it without risk.

Small Spill

CAUTION: For spills of Xanthates, UN3342 and for Dithionite (Hydrosulfite/Hydrosulphite), UN1384, UN1923 and UN1929, dissolve in 5 parts water and collect for proper disposal.

CAUTION: UN3342 when flooded with water will continue to evolve flammable Carbon disulfide/Carbon disulphide vapors.

- Cover with DRY earth, DRY sand or other non-combustible material followed with plastic sheet to minimize spreading or contact with rain.
- Use clean, non-sparking tools to collect material and place it into loosely covered plastic containers for later disposal.
- Prevent entry into waterways, sewers, basements or confined areas.

FIRST AID

- Call 911 or emergency medical service.
- Ensure that medical personnel are aware of the material(s) involved and take precautions to protect themselves.
- Move victim to fresh air if it can be done safely.
- Give artificial respiration if victim is not breathing.
- Administer oxygen if breathing is difficult.
- Remove and isolate contaminated clothing and shoes.
- In case of contact with substance, immediately flush skin or eyes with running water for at least 20 minutes.
- Keep victim calm and warm.

GUIDE 136 SUBSTANCES - SPONTANEOUSLY COMBUSTIBLE - TOXIC AND/OR CORROSIVE (AIR-REACTIVE)

POTENTIAL HAZARDS

FIRE OR EXPLOSION

- Extremely flammable; will ignite itself if exposed to air.
- Burns rapidly, releasing dense, white, irritating fumes.
- Substance may be transported in a molten form.
- May re-ignite after fire is extinguished.
- Corrosive substances in contact with metals may produce flammable hydrogen gas.
- Containers may explode when heated.

HEALTH

- Fire will produce irritating, corrosive and/or toxic gases.
- **TOXIC**; ingestion of substance or inhalation of decomposition products will cause severe injury or death.
- Contact with substance may cause severe burns to skin and eyes.
- Some effects may be experienced due to skin absorption.
- Runoff from fire control or dilution water may be corrosive and/or toxic and cause environmental contamination.

PUBLIC SAFETY

- **CALL 911. Then call emergency response telephone number on shipping paper.** If shipping paper not available or no answer, refer to appropriate telephone number listed on the inside back cover.
- Stay upwind, uphill and/or upstream.
- Keep unauthorized personnel away.

PROTECTIVE CLOTHING

- Wear positive pressure self-contained breathing apparatus (SCBA).
- Wear chemical protective clothing that is specifically recommended by the manufacturer **when there is NO RISK OF FIRE.**
- Structural firefighters' protective clothing provides thermal protection **but only limited chemical protection.**
- **For Phosphorus (UN1381): Special aluminized protective clothing should be worn when direct contact with the substance is possible.**

EVACUATION

Immediate precautionary measure

- Isolate spill or leak area in all directions for at least 50 meters (150 feet) for liquids and at least 25 meters (75 feet) for solids.

Spill

- Consider initial downwind evacuation for at least 300 meters (1000 feet).

Fire

- If tank, rail car or tank truck is involved in a fire, ISOLATE for 800 meters (1/2 mile) in all directions; also, consider initial evacuation for 800 meters (1/2 mile) in all directions.



In Canada, an Emergency Response Assistance Plan (ERAP) may be required for this product. Please consult the shipping paper and/or the ERAP Program Section (page 390).

EMERGENCY RESPONSE

FIRE

Small Fire

- Water spray, wet sand or wet earth.

Large Fire

- Water spray or fog.
- **Do not scatter spilled material with high-pressure water streams.**
- If it can be done safely, move undamaged containers away from the area around the fire.

Fire Involving Tanks or Car/Trailer Loads

- Fight fire from maximum distance or use unmanned master stream devices or monitor nozzles.
- Cool containers with flooding quantities of water until well after fire is out.
- Withdraw immediately in case of rising sound from venting safety devices or discoloration of tank.
- **ALWAYS** stay away from tanks engulfed in fire.

SPILL OR LEAK

- **ELIMINATE** all ignition sources (no smoking, flares, sparks or flames) from immediate area.
- Do not touch or walk through spilled material.
- Do not touch damaged containers or spilled material unless wearing appropriate protective clothing.
- Stop leak if you can do it without risk.

Small Spill

- Cover with water, sand or earth. Shovel into metal container and keep material under water.

Large Spill

- Dike for later disposal and cover with wet sand or earth.
- Prevent entry into waterways, sewers, basements or confined areas.

FIRST AID

- Call 911 or emergency medical service.
- Ensure that medical personnel are aware of the material(s) involved and take precautions to protect themselves.
- Move victim to fresh air if it can be done safely.
- Give artificial respiration if victim is not breathing.
- Administer oxygen if breathing is difficult.
- In case of contact with substance, keep exposed skin areas immersed in water or covered with wet bandages until medical attention is received.
- Removal of solidified molten material from skin requires medical assistance.
- Remove and isolate contaminated clothing and shoes at the site and place in metal container filled with water. Fire hazard if allowed to dry.
- Effects of exposure (inhalation, ingestion or skin contact) to substance may be delayed.
- Keep victim calm and warm.

GUIDE SUBSTANCES - WATER-REACTIVE - CORROSIVE

137

POTENTIAL HAZARDS

HEALTH

- CORROSIVE and/or TOXIC; inhalation, ingestion or contact (skin, eyes) with vapors, dusts or substance may cause severe injury, burns or death.
- Fire will produce irritating, corrosive and/or toxic gases.
- Reaction with water may generate much heat that will increase the concentration of fumes in the air.
- Contact with molten substance may cause severe burns to skin and eyes.
- Runoff from fire control or dilution water may cause environmental contamination.

FIRE OR EXPLOSION

- **EXCEPT FOR ACETIC ANHYDRIDE (UN1715), THAT IS FLAMMABLE**, some of these materials may burn, but none ignite readily.
- May ignite combustibles (wood, paper, oil, clothing, etc.).
- Substance will react with water (some violently), releasing corrosive and/or toxic gases and runoff.
- Flammable/toxic gases may accumulate in confined areas (basement, tanks, hopper/tank cars, etc.).
- Contact with metals may evolve flammable hydrogen gas.
- Containers may explode when heated or if contaminated with water.
- Substance may be transported in a molten form.

PUBLIC SAFETY

- **CALL 911. Then call emergency response telephone number on shipping paper.** If shipping paper not available or no answer, refer to appropriate telephone number listed on the inside back cover.
- Keep unauthorized personnel away.
- Stay upwind, uphill and/or upstream.
- Ventilate closed spaces before entering, but only if properly trained and equipped.

PROTECTIVE CLOTHING

- Wear positive pressure self-contained breathing apparatus (SCBA).
- Wear chemical protective clothing that is specifically recommended by the manufacturer **when there is NO RISK OF FIRE**.
- Structural firefighters' protective clothing provides thermal protection **but only limited chemical protection**.

EVACUATION

Immediate precautionary measure

- Isolate spill or leak area in all directions for at least 50 meters (150 feet) for liquids and at least 25 meters (75 feet) for solids.

Spill

- For **highlighted materials**: see Table 1 - Initial Isolation and Protective Action Distances.
- For non-highlighted materials: increase the immediate precautionary measure distance, in the downwind direction, as necessary.

Fire

- If tank, rail car or tank truck is involved in a fire, ISOLATE for 800 meters (1/2 mile) in all directions; also, consider initial evacuation for 800 meters (1/2 mile) in all directions.



In Canada, an Emergency Response Assistance Plan (ERAP) may be required for this product. Please consult the shipping paper and/or the ERAP Program Section (page 390).

EMERGENCY RESPONSE

FIRE

- **When material is not involved in fire, do not use water on material itself.**

Small Fire

- Dry chemical or CO₂.
- If it can be done safely, move undamaged containers away from the area around the fire.

Large Fire

- Flood fire area with large quantities of water, while knocking down vapors with water fog. If insufficient water supply, responders should withdraw.

Fire Involving Tanks or Car/Trailer Loads

- Cool containers with flooding quantities of water until well after fire is out.
- Do not get water inside containers.
- Withdraw immediately in case of rising sound from venting safety devices or discoloration of tank.
- ALWAYS stay away from tanks engulfed in fire.

SPILL OR LEAK

- Do not touch damaged containers or spilled material unless wearing appropriate protective clothing.
- Stop leak if you can do it without risk.
- Use water spray to reduce vapors; do not put water directly on leak, spill area or inside container.
- Keep combustibles (wood, paper, oil, etc.) away from spilled material.

Small Spill

- Cover with DRY earth, DRY sand or other non-combustible material followed with plastic sheet to minimize spreading or contact with rain.
- Use clean, non-sparking tools to collect material and place it into loosely covered plastic containers for later disposal.
- Prevent entry into waterways, sewers, basements or confined areas.

FIRST AID

- Call 911 or emergency medical service.
- Ensure that medical personnel are aware of the material(s) involved and take precautions to protect themselves.
- Move victim to fresh air if it can be done safely.
- Give artificial respiration if victim is not breathing.
- **Do not perform mouth-to-mouth resuscitation if victim ingested or inhaled the substance; wash face and mouth before giving artificial respiration. Use a pocket mask equipped with a one-way valve or other proper respiratory medical device.**
- Administer oxygen if breathing is difficult.
- Remove and isolate contaminated clothing and shoes.
- In case of contact with substance, immediately flush skin or eyes with running water for at least 20 minutes.
- For minor skin contact, avoid spreading material on unaffected skin.
- Removal of solidified molten material from skin requires medical assistance.
- Keep victim calm and warm.
- Effects of exposure (inhalation, ingestion or skin contact) to substance may be delayed.

GUIDE 138 SUBSTANCES - WATER-REACTIVE (EMITTING FLAMMABLE GASES)

POTENTIAL HAZARDS

FIRE OR EXPLOSION

- Produce flammable gases on contact with water.
- May ignite on contact with water or moist air.
- Some react vigorously or explosively on contact with water.
- May be ignited by heat, sparks or flames.
- May re-ignite after fire is extinguished.
- Some are transported in highly flammable liquids.
- Runoff may create fire or explosion hazard.

HEALTH

- Inhalation or contact with vapors, substance or decomposition products may cause severe injury or death.
- May produce corrosive solutions on contact with water.
- Fire will produce irritating, corrosive and/or toxic gases.
- Runoff from fire control or dilution water may cause environmental contamination.

PUBLIC SAFETY

- **CALL 911. Then call emergency response telephone number on shipping paper.** If shipping paper not available or no answer, refer to appropriate telephone number listed on the inside back cover.
- Keep unauthorized personnel away.
- Stay upwind, uphill and/or upstream.
- Ventilate closed spaces before entering, but only if properly trained and equipped.

PROTECTIVE CLOTHING

- Wear positive pressure self-contained breathing apparatus (SCBA).
- Wear chemical protective clothing that is specifically recommended by the manufacturer **when there is NO RISK OF FIRE.**
- Structural firefighters' protective clothing provides thermal protection **but only limited chemical protection.**

EVACUATION

Immediate precautionary measure

- Isolate spill or leak area in all directions for at least 50 meters (150 feet) for liquids and at least 25 meters (75 feet) for solids.

Spill

- For **highlighted materials**: see Table 1 - Initial Isolation and Protective Action Distances.
- For non-highlighted materials: increase the immediate precautionary measure distance, in the downwind direction, as necessary.

Fire

- If tank, rail car or tank truck is involved in a fire, ISOLATE for 800 meters (1/2 mile) in all directions; also, consider initial evacuation for 800 meters (1/2 mile) in all directions.



In Canada, an Emergency Response Assistance Plan (ERAP) may be required for this product. Please consult the shipping paper and/or the ERAP Program Section (page 390).

EMERGENCY RESPONSE

FIRE

- **DO NOT USE WATER OR FOAM.**

Small Fire

- Dry chemical, soda ash, lime or sand.

Large Fire

- DRY sand, dry chemical, soda ash or lime or withdraw from area and let fire burn.
- If it can be done safely, move undamaged containers away from the area around the fire.

Fire Involving Metals or Powders (Aluminum, Lithium, Magnesium, etc.)

- Use dry chemical, DRY sand, sodium chloride powder, graphite powder or class D extinguishers; in addition, for Lithium you may use Lith-X® powder or copper powder. Also, see GUIDE 170.

Fire Involving Tanks or Car/Trailer Loads

- Fight fire from maximum distance or use unmanned master stream devices or monitor nozzles.
- Do not get water inside containers.
- Cool containers with flooding quantities of water until well after fire is out.
- Withdraw immediately in case of rising sound from venting safety devices or discoloration of tank.
- ALWAYS stay away from tanks engulfed in fire.

SPILL OR LEAK

- ELIMINATE all ignition sources (no smoking, flares, sparks or flames) from immediate area.
- Do not touch or walk through spilled material.
- Stop leak if you can do it without risk.
- Use water spray to reduce vapors or divert vapor cloud drift. Avoid allowing water runoff to contact spilled material.
- **DO NOT GET WATER on spilled substance or inside containers.**

Small Spill

- Cover with DRY earth, DRY sand or other non-combustible material followed with plastic sheet to minimize spreading or contact with rain.
- Dike for later disposal; do not apply water unless directed to do so.

Powder Spill

- Cover powder spill with plastic sheet or tarp to minimize spreading and keep powder dry.
- **DO NOT CLEAN-UP OR DISPOSE OF, EXCEPT UNDER SUPERVISION OF A SPECIALIST.**

FIRST AID

- Call 911 or emergency medical service.
- Ensure that medical personnel are aware of the material(s) involved and take precautions to protect themselves.
- Move victim to fresh air if it can be done safely.
- Give artificial respiration if victim is not breathing.
- Administer oxygen if breathing is difficult.
- Remove and isolate contaminated clothing and shoes.
- In case of contact with substance, wipe from skin immediately; flush skin or eyes with running water for at least 20 minutes.
- Keep victim calm and warm.

GUIDE 139 SUBSTANCES - WATER-REACTIVE (EMITTING FLAMMABLE AND TOXIC GASES)

POTENTIAL HAZARDS

FIRE OR EXPLOSION

- Produce flammable and toxic gases on contact with water.
- May ignite on contact with water or moist air.
- Some react vigorously or explosively on contact with water.
- May be ignited by heat, sparks or flames.
- May re-ignite after fire is extinguished.
- Some are transported in highly flammable liquids.
- Containers may explode when heated.
- Runoff may create fire or explosion hazard.

HEALTH

- Highly toxic: contact with water produces toxic gas, may be fatal if inhaled.
- Inhalation or contact with vapors, substance or decomposition products may cause severe injury or death.
- May produce corrosive solutions on contact with water.
- Fire will produce irritating, corrosive and/or toxic gases.
- Runoff from fire control or dilution water may cause environmental contamination.

PUBLIC SAFETY

- **CALL 911. Then call emergency response telephone number on shipping paper.** If shipping paper not available or no answer, refer to appropriate telephone number listed on the inside back cover.
- Keep unauthorized personnel away.
- Stay upwind, uphill and/or upstream.
- Ventilate closed spaces before entering, but only if properly trained and equipped.

PROTECTIVE CLOTHING

- Wear positive pressure self-contained breathing apparatus (SCBA).
- Wear chemical protective clothing that is specifically recommended by the manufacturer **when there is NO RISK OF FIRE.**
- Structural firefighters' protective clothing provides thermal protection **but only limited chemical protection.**

EVACUATION

Immediate precautionary measure

- Isolate spill or leak area in all directions for at least 50 meters (150 feet) for liquids and at least 25 meters (75 feet) for solids.

Spill

- For **highlighted materials**: see Table 1 - Initial Isolation and Protective Action Distances.
- For non-highlighted materials: increase the immediate precautionary measure distance, in the downwind direction, as necessary.

Fire

- If tank, rail car or tank truck is involved in a fire, ISOLATE for 800 meters (1/2 mile) in all directions; also, consider initial evacuation for 800 meters (1/2 mile) in all directions.



In Canada, an Emergency Response Assistance Plan (ERAP) may be required for this product. Please consult the shipping paper and/or the ERAP Program Section (page 390).

EMERGENCY RESPONSE

FIRE

- **DO NOT USE WATER OR FOAM. (FOAM MAY BE USED FOR CHLOROSILANES, SEE BELOW)**

Small Fire

- Dry chemical, soda ash, lime or sand.

Large Fire

- DRY sand, dry chemical, soda ash or lime or withdraw from area and let fire burn.
- **FOR CHLOROSILANES, DO NOT USE WATER;** use AFFF alcohol-resistant medium-expansion foam; **DO NOT USE** dry chemicals, soda ash or lime on chlorosilane fires (large or small) as they may release large quantities of hydrogen gas that may explode.
- If it can be done safely, move undamaged containers away from the area around the fire.

Fire Involving Tanks or Car/Trailer Loads

- Fight fire from maximum distance or use unmanned master stream devices or monitor nozzles.
- Cool containers with flooding quantities of water until well after fire is out.
- Do not get water inside containers.
- Withdraw immediately in case of rising sound from venting safety devices or discoloration of tank.
- **ALWAYS** stay away from tanks engulfed in fire.

SPILL OR LEAK

- **ELIMINATE** all ignition sources (no smoking, flares, sparks or flames) from immediate area.
- Do not touch or walk through spilled material.
- Stop leak if you can do it without risk.
- **DO NOT GET WATER on spilled substance or inside containers.**
- Use water spray to reduce vapors or divert vapor cloud drift. Avoid allowing water runoff to contact spilled material.
- **FOR CHLOROSILANES,** use AFFF alcohol-resistant medium-expansion foam to reduce vapors.

Small Spill

- Cover with DRY earth, DRY sand or other non-combustible material followed with plastic sheet to minimize spreading or contact with rain.
- Dike for later disposal; do not apply water unless directed to do so.

Powder Spill

- Cover powder spill with plastic sheet or tarp to minimize spreading and keep powder dry.
- **DO NOT CLEAN-UP OR DISPOSE OF, EXCEPT UNDER SUPERVISION OF A SPECIALIST.**

FIRST AID

- Call 911 or emergency medical service.
- Ensure that medical personnel are aware of the material(s) involved and take precautions to protect themselves.
- Move victim to fresh air if it can be done safely.
- Give artificial respiration if victim is not breathing.
- **Do not perform mouth-to-mouth resuscitation if victim ingested or inhaled the substance; wash face and mouth before giving artificial respiration. Use a pocket mask equipped with a one-way valve or other proper respiratory medical device.**
- Administer oxygen if breathing is difficult.
- Remove and isolate contaminated clothing and shoes.
- In case of contact with substance, wipe from skin immediately; flush skin or eyes with running water for at least 20 minutes.
- Keep victim calm and warm.

POTENTIAL HAZARDS

FIRE OR EXPLOSION

- These substances will accelerate burning when involved in a fire.
- Some may decompose explosively when heated or involved in a fire.
- May explode from heat or contamination.
- Some will react explosively with hydrocarbons (fuels).
- May ignite combustibles (wood, paper, oil, clothing, etc.).
- Containers may explode when heated.
- Runoff may create fire or explosion hazard.

HEALTH

- Inhalation, ingestion or contact (skin, eyes) with vapors or substance may cause severe injury, burns or death.
- Fire may produce irritating, corrosive and/or toxic gases.
- Runoff from fire control or dilution water may cause environmental contamination.

PUBLIC SAFETY

- **CALL 911. Then call emergency response telephone number on shipping paper.** If shipping paper not available or no answer, refer to appropriate telephone number listed on the inside back cover.
- Keep unauthorized personnel away.
- Stay upwind, uphill and/or upstream.
- Ventilate closed spaces before entering, but only if properly trained and equipped.

PROTECTIVE CLOTHING

- Wear positive pressure self-contained breathing apparatus (SCBA).
- Wear chemical protective clothing that is specifically recommended by the manufacturer **when there is NO RISK OF FIRE.**
- Structural firefighters' protective clothing provides thermal protection **but only limited chemical protection.**

EVACUATION

Immediate precautionary measure

- Isolate spill or leak area in all directions for at least 50 meters (150 feet) for liquids and at least 25 meters (75 feet) for solids.

Large Spill

- Consider initial downwind evacuation for at least 100 meters (330 feet).

Fire

- If tank, rail car or tank truck is involved in a fire, ISOLATE for 800 meters (1/2 mile) in all directions; also, consider initial evacuation for 800 meters (1/2 mile) in all directions.
- If **ammonium nitrate** is in a tank, rail car or tank truck and involved in a fire, ISOLATE for 1600 meters (1 mile) in all directions; also, initiate evacuation including emergency responders for 1600 meters (1 mile) in all directions.



In Canada, an Emergency Response Assistance Plan (ERAP) may be required for this product. Please consult the shipping paper and/or the ERAP Program Section (page 390).

EMERGENCY RESPONSE**FIRE****Small Fire**

- Use water. Do not use dry chemicals or foams. CO₂ or Halon® may provide limited control.

Large Fire

- Flood fire area with water from a distance.
- Do not move cargo or vehicle if cargo has been exposed to heat.
- If it can be done safely, move undamaged containers away from the area around the fire.

Fire Involving Tanks or Car/Trailer Loads

- Fight fire from maximum distance or use unmanned master stream devices or monitor nozzles.
- Cool containers with flooding quantities of water until well after fire is out.
- ALWAYS stay away from tanks engulfed in fire.
- For massive fire, use unmanned master stream devices or monitor nozzles; if this is impossible, withdraw from area and let fire burn.

SPILL OR LEAK

- Keep combustibles (wood, paper, oil, etc.) away from spilled material.
- Do not touch damaged containers or spilled material unless wearing appropriate protective clothing.
- Stop leak if you can do it without risk.
- Do not get water inside containers.

Small Dry Spill

- With clean shovel, place material into clean, dry container and cover loosely; move containers from spill area.

Small Liquid Spill

- Use a non-combustible material like vermiculite or sand to soak up the product and place into a container for later disposal.

Large Spill

- Dike far ahead of liquid spill for later disposal.

FIRST AID

- Call 911 or emergency medical service.
- Ensure that medical personnel are aware of the material(s) involved and take precautions to protect themselves.
- Move victim to fresh air if it can be done safely.
- Give artificial respiration if victim is not breathing.
- Administer oxygen if breathing is difficult.
- Remove and isolate contaminated clothing and shoes.
- Contaminated clothing may be a fire risk when dry.
- In case of contact with substance, immediately flush skin or eyes with running water for at least 20 minutes.
- Keep victim calm and warm.

POTENTIAL HAZARDS

FIRE OR EXPLOSION

- These substances will accelerate burning when involved in a fire.
- May explode from heat or contamination.
- Some may burn rapidly.
- Some will react explosively with hydrocarbons (fuels).
- May ignite combustibles (wood, paper, oil, clothing, etc.).
- Containers may explode when heated.
- Runoff may create fire or explosion hazard.

HEALTH

- Toxic by ingestion.
- Inhalation of dust is toxic.
- Fire may produce irritating, corrosive and/or toxic gases.
- Contact with substance may cause severe burns to skin and eyes.
- Runoff from fire control or dilution water may cause environmental contamination.

PUBLIC SAFETY

- **CALL 911. Then call emergency response telephone number on shipping paper.** If shipping paper not available or no answer, refer to appropriate telephone number listed on the inside back cover.
- Keep unauthorized personnel away.
- Stay upwind, uphill and/or upstream.
- Ventilate closed spaces before entering, but only if properly trained and equipped.

PROTECTIVE CLOTHING

- Wear positive pressure self-contained breathing apparatus (SCBA).
- Wear chemical protective clothing that is specifically recommended by the manufacturer **when there is NO RISK OF FIRE.**
- Structural firefighters' protective clothing provides thermal protection **but only limited chemical protection.**

EVACUATION

Immediate precautionary measure

- Isolate spill or leak area in all directions for at least 50 meters (150 feet) for liquids and at least 25 meters (75 feet) for solids.

Large Spill

- Consider initial downwind evacuation for at least 100 meters (330 feet).

Fire

- If tank, rail car or tank truck is involved in a fire, ISOLATE for 800 meters (1/2 mile) in all directions; also, consider initial evacuation for 800 meters (1/2 mile) in all directions.



In Canada, an Emergency Response Assistance Plan (ERAP) may be required for this product. Please consult the shipping paper and/or the ERAP Program Section (page 390).

EMERGENCY RESPONSE

FIRE

Small Fire

- Use water. Do not use dry chemicals or foams. CO₂ or Halon® may provide limited control.

Large Fire

- Flood fire area with water from a distance.
- Do not move cargo or vehicle if cargo has been exposed to heat.
- If it can be done safely, move undamaged containers away from the area around the fire.

Fire Involving Tanks or Car/Trailer Loads

- Fight fire from maximum distance or use unmanned master stream devices or monitor nozzles.
- Cool containers with flooding quantities of water until well after fire is out.
- ALWAYS stay away from tanks engulfed in fire.
- For massive fire, use unmanned master stream devices or monitor nozzles; if this is impossible, withdraw from area and let fire burn.

SPILL OR LEAK

- Keep combustibles (wood, paper, oil, etc.) away from spilled material.
- Do not touch damaged containers or spilled material unless wearing appropriate protective clothing.
- Stop leak if you can do it without risk.

Small Dry Spill

- With clean shovel, place material into clean, dry container and cover loosely; move containers from spill area.

Large Spill

- Dike far ahead of spill for later disposal.

FIRST AID

- Call 911 or emergency medical service.
- Ensure that medical personnel are aware of the material(s) involved and take precautions to protect themselves.
- Move victim to fresh air if it can be done safely.
- Give artificial respiration if victim is not breathing.
- Administer oxygen if breathing is difficult.
- Remove and isolate contaminated clothing and shoes.
- Contaminated clothing may be a fire risk when dry.
- In case of contact with substance, immediately flush skin or eyes with running water for at least 20 minutes.
- Keep victim calm and warm.

GUIDE OXIDIZERS - TOXIC (LIQUID)

142

POTENTIAL HAZARDS

FIRE OR EXPLOSION

- These substances will accelerate burning when involved in a fire.
- May explode from heat or contamination.
- Some will react explosively with hydrocarbons (fuels).
- May ignite combustibles (wood, paper, oil, clothing, etc.).
- Containers may explode when heated.
- Runoff may create fire or explosion hazard.

HEALTH

- **TOXIC**; inhalation, ingestion or contact (skin, eyes) with vapors or substance may cause severe injury, burns or death.
- Fire may produce irritating, corrosive and/or toxic gases.
- Toxic/flammable fumes may accumulate in confined areas (basement, tanks, tank cars, etc.).
- Runoff from fire control or dilution water may cause environmental contamination.

PUBLIC SAFETY

- **CALL 911. Then call emergency response telephone number on shipping paper.** If shipping paper not available or no answer, refer to appropriate telephone number listed on the inside back cover.
- Keep unauthorized personnel away.
- Stay upwind, uphill and/or upstream.
- Ventilate closed spaces before entering, but only if properly trained and equipped.

PROTECTIVE CLOTHING

- Wear positive pressure self-contained breathing apparatus (SCBA).
- Wear chemical protective clothing that is specifically recommended by the manufacturer **when there is NO RISK OF FIRE.**
- Structural firefighters' protective clothing provides thermal protection **but only limited chemical protection.**

EVACUATION

Immediate precautionary measure

- Isolate spill or leak area for at least 50 meters (150 feet) in all directions.

Spill

- For **highlighted materials**: see Table 1 - Initial Isolation and Protective Action Distances.
- For non-highlighted materials: increase the immediate precautionary measure distance, in the downwind direction, as necessary.

Fire

- If tank, rail car or tank truck is involved in a fire, ISOLATE for 800 meters (1/2 mile) in all directions; also, consider initial evacuation for 800 meters (1/2 mile) in all directions.



In Canada, an Emergency Response Assistance Plan (ERAP) may be required for this product. Please consult the shipping paper and/or the ERAP Program Section (page 390).

EMERGENCY RESPONSE

FIRE

Small Fire

- Use water. Do not use dry chemicals or foams. CO₂ or Halon® may provide limited control.

Large Fire

- Flood fire area with water from a distance.
- Do not move cargo or vehicle if cargo has been exposed to heat.
- If it can be done safely, move undamaged containers away from the area around the fire.

Fire Involving Tanks or Car/Trailer Loads

- Fight fire from maximum distance or use unmanned master stream devices or monitor nozzles.
- Cool containers with flooding quantities of water until well after fire is out.
- ALWAYS stay away from tanks engulfed in fire.
- For massive fire, use unmanned master stream devices or monitor nozzles; if this is impossible, withdraw from area and let fire burn.

SPILL OR LEAK

- Keep combustibles (wood, paper, oil, etc.) away from spilled material.
- Do not touch damaged containers or spilled material unless wearing appropriate protective clothing.
- Stop leak if you can do it without risk.
- Use water spray to reduce vapors or divert vapor cloud drift.
- Do not get water inside containers.

Small Liquid Spill

- Use a non-combustible material like vermiculite or sand to soak up the product and place into a container for later disposal.

Large Spill

- Dike far ahead of liquid spill for later disposal.

FIRST AID

- Call 911 or emergency medical service.
- Ensure that medical personnel are aware of the material(s) involved and take precautions to protect themselves.
- Move victim to fresh air if it can be done safely.
- Give artificial respiration if victim is not breathing.
- **Do not perform mouth-to-mouth resuscitation if victim ingested or inhaled the substance; wash face and mouth before giving artificial respiration. Use a pocket mask equipped with a one-way valve or other proper respiratory medical device.**
- Administer oxygen if breathing is difficult.
- Remove and isolate contaminated clothing and shoes.
- Contaminated clothing may be a fire risk when dry.
- In case of contact with substance, immediately flush skin or eyes with running water for at least 20 minutes.
- Keep victim calm and warm.

POTENTIAL HAZARDS

FIRE OR EXPLOSION

- May explode from friction, heat or contamination.
- These substances will accelerate burning when involved in a fire.
- May ignite combustibles (wood, paper, oil, clothing, etc.).
- Some will react explosively with hydrocarbons (fuels).
- Containers may explode when heated.
- Runoff may create fire or explosion hazard.

HEALTH

- **TOXIC**; inhalation, ingestion or contact (skin, eyes) with vapors, dusts or substance may cause severe injury, burns or death.
- Fire may produce irritating and/or toxic gases.
- Toxic fumes or dust may accumulate in confined areas (basement, tanks, hopper/tank cars, etc.).
- Runoff from fire control or dilution water may cause environmental contamination.

PUBLIC SAFETY

- **CALL 911. Then call emergency response telephone number on shipping paper.** If shipping paper not available or no answer, refer to appropriate telephone number listed on the inside back cover.
- Keep unauthorized personnel away.
- Stay upwind, uphill and/or upstream.
- Ventilate closed spaces before entering, but only if properly trained and equipped.

PROTECTIVE CLOTHING

- Wear positive pressure self-contained breathing apparatus (SCBA).
- Wear chemical protective clothing that is specifically recommended by the manufacturer **when there is NO RISK OF FIRE.**
- Structural firefighters' protective clothing provides thermal protection **but only limited chemical protection.**

EVACUATION

Immediate precautionary measure

- Isolate spill or leak area in all directions for at least 50 meters (150 feet) for liquids and at least 25 meters (75 feet) for solids.

Spill

- For **highlighted materials**: see Table 1 - Initial Isolation and Protective Action Distances.
- For non-highlighted materials: increase the immediate precautionary measure distance, in the downwind direction, as necessary.

Fire

- If tank, rail car or tank truck is involved in a fire, ISOLATE for 800 meters (1/2 mile) in all directions; also, consider initial evacuation for 800 meters (1/2 mile) in all directions.



In Canada, an Emergency Response Assistance Plan (ERAP) may be required for this product. Please consult the shipping paper and/or the ERAP Program Section (page 390).

EMERGENCY RESPONSE

FIRE

Small Fire

- Use water. Do not use dry chemicals or foams. CO₂ or Halon® may provide limited control.

Large Fire

- Flood fire area with water from a distance.
- Do not move cargo or vehicle if cargo has been exposed to heat.
- If it can be done safely, move undamaged containers away from the area around the fire.
- Do not get water inside containers: a violent reaction may occur.

Fire Involving Tanks or Car/Trailer Loads

- Cool containers with flooding quantities of water until well after fire is out.
- Dike runoff from fire control for later disposal.
- ALWAYS stay away from tanks engulfed in fire.
- For massive fire, use unmanned master stream devices or monitor nozzles; if this is impossible, withdraw from area and let fire burn.

SPILL OR LEAK

- Keep combustibles (wood, paper, oil, etc.) away from spilled material.
- Do not touch damaged containers or spilled material unless wearing appropriate protective clothing.
- Use water spray to reduce vapors or divert vapor cloud drift.
- Prevent entry into waterways, sewers, basements or confined areas.

Small Spill

- Flush area with large amounts of water.

Large Spill

- **DO NOT CLEAN-UP OR DISPOSE OF, EXCEPT UNDER SUPERVISION OF A SPECIALIST.**

FIRST AID

- Call 911 or emergency medical service.
- Ensure that medical personnel are aware of the material(s) involved and take precautions to protect themselves.
- Move victim to fresh air if it can be done safely.
- Give artificial respiration if victim is not breathing.
- Administer oxygen if breathing is difficult.
- Remove and isolate contaminated clothing and shoes.
- Contaminated clothing may be a fire risk when dry.
- In case of contact with substance, immediately flush skin or eyes with running water for at least 20 minutes.
- Keep victim calm and warm.

POTENTIAL HAZARDS

FIRE OR EXPLOSION

- May ignite combustibles (wood, paper, oil, clothing, etc.).
- React vigorously and/or explosively with water.
- Produce toxic and/or corrosive substances on contact with water.
- Flammable/toxic gases may accumulate in tanks and hopper cars.
- Some may produce flammable hydrogen gas upon contact with metals.
- Containers may explode when heated.
- Runoff may create fire or explosion hazard.

HEALTH

- **TOXIC**; inhalation or contact with vapor, substance, or decomposition products may cause severe injury or death.
- Fire will produce irritating, corrosive and/or toxic gases.
- Runoff from fire control or dilution water may cause environmental contamination.

PUBLIC SAFETY

- **CALL 911. Then call emergency response telephone number on shipping paper.** If shipping paper not available or no answer, refer to appropriate telephone number listed on the inside back cover.
- Keep unauthorized personnel away.
- Stay upwind, uphill and/or upstream.
- Ventilate closed spaces before entering, but only if properly trained and equipped.

PROTECTIVE CLOTHING

- Wear positive pressure self-contained breathing apparatus (SCBA).
- Wear chemical protective clothing that is specifically recommended by the manufacturer **when there is NO RISK OF FIRE.**
- Structural firefighters' protective clothing provides thermal protection **but only limited chemical protection.**

EVACUATION

Immediate precautionary measure

- Isolate spill or leak area in all directions for at least 50 meters (150 feet) for liquids and at least 25 meters (75 feet) for solids.

Spill

- For **highlighted materials**: see Table 1 - Initial Isolation and Protective Action Distances.
- For non-highlighted materials: increase the immediate precautionary measure distance, in the downwind direction, as necessary.

Fire

- If tank, rail car or tank truck is involved in a fire, ISOLATE for 800 meters (1/2 mile) in all directions; also, consider initial evacuation for 800 meters (1/2 mile) in all directions.



In Canada, an Emergency Response Assistance Plan (ERAP) may be required for this product. Please consult the shipping paper and/or the ERAP Program Section (page 390).

EMERGENCY RESPONSE

FIRE

- **DO NOT USE WATER OR FOAM.**

Small Fire

- Dry chemical, soda ash or lime.

Large Fire

- DRY sand, dry chemical, soda ash or lime or withdraw from area and let fire burn.
- Do not move cargo or vehicle if cargo has been exposed to heat.
- If it can be done safely, move undamaged containers away from the area around the fire.

Fire Involving Tanks or Car/Trailer Loads

- Fight fire from maximum distance or use unmanned master stream devices or monitor nozzles.
- Cool containers with flooding quantities of water until well after fire is out.
- Withdraw immediately in case of rising sound from venting safety devices or discoloration of tank.
- ALWAYS stay away from tanks engulfed in fire.

SPILL OR LEAK

- ELIMINATE all ignition sources (no smoking, flares, sparks or flames) from immediate area.
- Do not touch damaged containers or spilled material unless wearing appropriate protective clothing.
- Stop leak if you can do it without risk.
- Use water spray to reduce vapors or divert vapor cloud drift. Avoid allowing water runoff to contact spilled material.
- **DO NOT GET WATER on spilled substance or inside containers.**

Small Spill

- Cover with DRY earth, DRY sand or other non-combustible material followed with plastic sheet to minimize spreading or contact with rain.

Large Spill

- **DO NOT CLEAN-UP OR DISPOSE OF, EXCEPT UNDER SUPERVISION OF A SPECIALIST.**

FIRST AID

- Call 911 or emergency medical service.
- Ensure that medical personnel are aware of the material(s) involved and take precautions to protect themselves.
- Move victim to fresh air if it can be done safely.
- Give artificial respiration if victim is not breathing.
- **Do not perform mouth-to-mouth resuscitation if victim ingested or inhaled the substance; wash face and mouth before giving artificial respiration. Use a pocket mask equipped with a one-way valve or other proper respiratory medical device.**
- Administer oxygen if breathing is difficult.
- Remove and isolate contaminated clothing and shoes.
- Contaminated clothing may be a fire risk when dry.
- In case of contact with substance, immediately flush skin or eyes with running water for at least 20 minutes.
- Keep victim calm and warm.
- Keep victim under observation.
- Effects of contact or inhalation may be delayed.

GUIDE 145 ORGANIC PEROXIDES (HEAT AND CONTAMINATION SENSITIVE)

POTENTIAL HAZARDS

FIRE OR EXPLOSION

- May explode from heat or contamination.
- May ignite combustibles (wood, paper, oil, clothing, etc.).
- May be ignited by heat, sparks or flames.
- May burn rapidly with flare-burning effect.
- Containers may explode when heated.
- Runoff may create fire or explosion hazard.

HEALTH

- Fire may produce irritating, corrosive and/or toxic gases.
- Ingestion or contact (skin, eyes) with substance may cause severe injury or burns.
- Runoff from fire control or dilution water may cause environmental contamination.

PUBLIC SAFETY

- **CALL 911. Then call emergency response telephone number on shipping paper.** If shipping paper not available or no answer, refer to appropriate telephone number listed on the inside back cover.
- Keep unauthorized personnel away.
- Stay upwind, uphill and/or upstream.

PROTECTIVE CLOTHING

- Wear positive pressure self-contained breathing apparatus (SCBA).
- Wear chemical protective clothing that is specifically recommended by the manufacturer **when there is NO RISK OF FIRE.**
- Structural firefighters' protective clothing provides thermal protection **but only limited chemical protection.**

EVACUATION

Immediate precautionary measure

- Isolate spill or leak area in all directions for at least 50 meters (150 feet) for liquids and at least 25 meters (75 feet) for solids.

Large Spill

- Consider initial evacuation for at least 250 meters (800 feet) in all directions.

Fire

- If tank, rail car or tank truck is involved in a fire, ISOLATE for 800 meters (1/2 mile) in all directions; also, consider initial evacuation for 800 meters (1/2 mile) in all directions.

EMERGENCY RESPONSE

FIRE**Small Fire**

- Water spray or fog is preferred; if water not available use dry chemical, CO₂ or regular foam.

Large Fire

- Flood fire area with water from a distance.
- Use water spray or fog; avoid aiming straight or solid streams directly onto the product.
- Do not move cargo or vehicle if cargo has been exposed to heat.
- If it can be done safely, move undamaged containers away from the area around the fire.

Fire Involving Tanks or Car/Trailer Loads

- Fight fire from maximum distance or use unmanned master stream devices or monitor nozzles.
- Cool containers with flooding quantities of water until well after fire is out.
- ALWAYS stay away from tanks engulfed in fire.
- For massive fire, use unmanned master stream devices or monitor nozzles; if this is impossible, withdraw from area and let fire burn.

SPILL OR LEAK

- ELIMINATE all ignition sources (no smoking, flares, sparks or flames) from immediate area.
- Keep combustibles (wood, paper, oil, etc.) away from spilled material.
- Do not touch damaged containers or spilled material unless wearing appropriate protective clothing.
- Keep substance wet using water spray.
- Stop leak if you can do it without risk.

Small Spill

- Pick up with inert, damp, non-combustible material using clean, non-sparking tools and place into loosely covered plastic containers for later disposal.

Large Spill

- Wet down with water and dike for later disposal.
- Prevent entry into waterways, sewers, basements or confined areas.
- **DO NOT CLEAN-UP OR DISPOSE OF, EXCEPT UNDER SUPERVISION OF A SPECIALIST.**

FIRST AID

- Call 911 or emergency medical service.
- Ensure that medical personnel are aware of the material(s) involved and take precautions to protect themselves.
- Move victim to fresh air if it can be done safely.
- Give artificial respiration if victim is not breathing.
- Administer oxygen if breathing is difficult.
- Remove and isolate contaminated clothing and shoes.
- Contaminated clothing may be a fire risk when dry.
- Remove material from skin immediately.
- In case of contact with substance, immediately flush skin or eyes with running water for at least 20 minutes.
- Keep victim calm and warm.

GUIDE 146 ORGANIC PEROXIDES (HEAT, CONTAMINATION AND FRICTION SENSITIVE)

POTENTIAL HAZARDS

FIRE OR EXPLOSION

- May explode from heat, shock, friction or contamination.
- May ignite combustibles (wood, paper, oil, clothing, etc.).
- May be ignited by heat, sparks or flames.
- May burn rapidly with flare-burning effect.
- Containers may explode when heated.
- Runoff may create fire or explosion hazard.

HEALTH

- Fire may produce irritating, corrosive and/or toxic gases.
- Ingestion or contact (skin, eyes) with substance may cause severe injury or burns.
- Runoff from fire control or dilution water may cause environmental contamination.

PUBLIC SAFETY

- **CALL 911. Then call emergency response telephone number on shipping paper.** If shipping paper not available or no answer, refer to appropriate telephone number listed on the inside back cover.
- Keep unauthorized personnel away.
- Stay upwind, uphill and/or upstream.

PROTECTIVE CLOTHING

- Wear positive pressure self-contained breathing apparatus (SCBA).
- Wear chemical protective clothing that is specifically recommended by the manufacturer **when there is NO RISK OF FIRE.**
- Structural firefighters' protective clothing provides thermal protection **but only limited chemical protection.**

EVACUATION

Immediate precautionary measure

- Isolate spill or leak area in all directions for at least 50 meters (150 feet) for liquids and at least 25 meters (75 feet) for solids.

Large Spill

- Consider initial evacuation for at least 250 meters (800 feet) in all directions.

Fire

- If tank, rail car or tank truck is involved in a fire, ISOLATE for 800 meters (1/2 mile) in all directions; also, consider initial evacuation for 800 meters (1/2 mile) in all directions.



In Canada, an Emergency Response Assistance Plan (ERAP) may be required for this product. Please consult the shipping paper and/or the ERAP Program Section (page 390).

EMERGENCY RESPONSE

FIRE

Small Fire

- Water spray or fog is preferred; if water not available use dry chemical, CO₂ or regular foam.

Large Fire

- Flood fire area with water from a distance.
- Use water spray or fog; avoid aiming straight or solid streams directly onto the product.
- Do not move cargo or vehicle if cargo has been exposed to heat.
- If it can be done safely, move undamaged containers away from the area around the fire.

Fire Involving Tanks or Car/Trailer Loads

- Fight fire from maximum distance or use unmanned master stream devices or monitor nozzles.
- Cool containers with flooding quantities of water until well after fire is out.
- ALWAYS stay away from tanks engulfed in fire.
- For massive fire, use unmanned master stream devices or monitor nozzles; if this is impossible, withdraw from area and let fire burn.

SPILL OR LEAK

- ELIMINATE all ignition sources (no smoking, flares, sparks or flames) from immediate area.
- Keep combustibles (wood, paper, oil, etc.) away from spilled material.
- Do not touch damaged containers or spilled material unless wearing appropriate protective clothing.
- Keep substance wet using water spray.
- Stop leak if you can do it without risk.

Small Spill

- Pick up with inert, damp, non-combustible material using clean, non-sparking tools and place into loosely covered plastic containers for later disposal.

Large Spill

- Wet down with water and dike for later disposal.
- Prevent entry into waterways, sewers, basements or confined areas.
- **DO NOT CLEAN-UP OR DISPOSE OF, EXCEPT UNDER SUPERVISION OF A SPECIALIST.**

FIRST AID

- Call 911 or emergency medical service.
- Ensure that medical personnel are aware of the material(s) involved and take precautions to protect themselves.
- Move victim to fresh air if it can be done safely.
- Give artificial respiration if victim is not breathing.
- Administer oxygen if breathing is difficult.
- Remove and isolate contaminated clothing and shoes.
- Contaminated clothing may be a fire risk when dry.
- Remove material from skin immediately.
- In case of contact with substance, immediately flush skin or eyes with running water for at least 20 minutes.
- Keep victim calm and warm.

POTENTIAL HAZARDS

FIRE OR EXPLOSION

- Lithium ion batteries contain flammable liquid electrolyte that may vent, ignite and produce sparks when subjected to high temperatures (> 150°C (302°F)), when damaged or abused (e.g., mechanical damage or electrical overcharging).
- May burn rapidly with flare-burning effect.
- May ignite other batteries in close proximity.

HEALTH

- Contact with battery electrolyte may be irritating to skin, eyes and mucous membranes.
- Fire will produce irritating, corrosive and/or toxic gases.
- Burning batteries may produce toxic hydrogen fluoride gas (see GUIDE 125).
- Fumes may cause dizziness or asphyxiation.

PUBLIC SAFETY

- **CALL 911. Then call emergency response telephone number on shipping paper.** If shipping paper not available or no answer, refer to appropriate telephone number listed on the inside back cover.
- Keep unauthorized personnel away.
- Stay upwind, uphill and/or upstream.
- Ventilate closed spaces before entering, but only if properly trained and equipped.

PROTECTIVE CLOTHING

- Wear positive pressure self-contained breathing apparatus (SCBA).
- Structural firefighters' protective clothing provides thermal protection **but only limited chemical protection.**

EVACUATION

Immediate precautionary measure

- Isolate spill or leak area for at least 25 meters (75 feet) in all directions.

Large Spill

- Consider initial downwind evacuation for at least 100 meters (330 feet).

Fire

- If rail car or trailer is involved in a fire, ISOLATE for 500 meters (1/3 mile) in all directions; also initiate evacuation including emergency responders for 500 meters (1/3 mile) in all directions.

EMERGENCY RESPONSE**FIRE****Small Fire**

- Dry chemical, CO₂, water spray or regular foam.

Large Fire

- Water spray, fog or regular foam.
- If it can be done safely, move undamaged containers away from the area around the fire.

SPILL OR LEAK

- ELIMINATE all ignition sources (no smoking, flares, sparks or flames) from immediate area.
- Do not touch or walk through spilled material.
- Absorb with earth, sand or other non-combustible material.
- Leaking batteries and contaminated absorbent material should be placed in metal containers.

FIRST AID

- Call 911 or emergency medical service.
- Ensure that medical personnel are aware of the material(s) involved and take precautions to protect themselves.
- Move victim to fresh air if it can be done safely.
- Give artificial respiration if victim is not breathing.
- Administer oxygen if breathing is difficult.
- Remove and isolate contaminated clothing and shoes.
- In case of contact with substance, immediately flush skin or eyes with running water for at least 20 minutes.

GUIDE 148 ORGANIC PEROXIDES (HEAT AND CONTAMINATION SENSITIVE/TEMPERATURE CONTROLLED)

POTENTIAL HAZARDS

FIRE OR EXPLOSION

- May explode from heat, contamination or loss of temperature control.
- These materials are particularly sensitive to temperature rises. Above a given "Control Temperature" they decompose violently and catch fire.
- May ignite combustibles (wood, paper, oil, clothing, etc.).
- May ignite spontaneously if exposed to air.
- May be ignited by heat, sparks or flames.
- May burn rapidly with flare-burning effect.
- Containers may explode when heated.
- Runoff may create fire or explosion hazard.

HEALTH

- Fire may produce irritating, corrosive and/or toxic gases.
- Ingestion or contact (skin, eyes) with substance may cause severe injury or burns.
- Runoff from fire control or dilution water may cause environmental contamination.

PUBLIC SAFETY

- **CALL 911. Then call emergency response telephone number on shipping paper.** If shipping paper not available or no answer, refer to appropriate telephone number listed on the inside back cover.
- Keep unauthorized personnel away.
- Stay upwind, uphill and/or upstream.

PROTECTIVE CLOTHING

- Wear positive pressure self-contained breathing apparatus (SCBA).
- Wear chemical protective clothing that is specifically recommended by the manufacturer **when there is NO RISK OF FIRE.**
- Structural firefighters' protective clothing provides thermal protection **but only limited chemical protection.**

EVACUATION

Immediate precautionary measure

- Isolate spill or leak area in all directions for at least 50 meters (150 feet) for liquids and at least 25 meters (75 feet) for solids.

Large Spill

- Consider initial evacuation for at least 250 meters (800 feet) in all directions.

Fire

- If tank, rail car or tank truck is involved in a fire, ISOLATE for 800 meters (1/2 mile) in all directions; also, consider initial evacuation for 800 meters (1/2 mile) in all directions.



In Canada, an Emergency Response Assistance Plan (ERAP) may be required for this product. Please consult the shipping paper and/or the ERAP Program Section (page 390).

EMERGENCY RESPONSE

FIRE

- The temperature of the substance must be maintained at or below the "Control Temperature" at all times.

Small Fire

- Water spray or fog is preferred; if water not available use dry chemical, CO₂ or regular foam.

Large Fire

- Flood fire area with water from a distance.
- Use water spray or fog; avoid aiming straight or solid streams directly onto the product.
- Do not move cargo or vehicle if cargo has been exposed to heat.
- If it can be done safely, move undamaged containers away from the area around the fire.

Fire Involving Tanks or Car/Trailer Loads

- Fight fire from maximum distance or use unmanned master stream devices or monitor nozzles.
- Cool containers with flooding quantities of water until well after fire is out.
- **BEWARE OF POSSIBLE CONTAINER EXPLOSION.**
- ALWAYS stay away from tanks engulfed in fire.
- For massive fire, use unmanned master stream devices or monitor nozzles; if this is impossible, withdraw from area and let fire burn.

SPILL OR LEAK

- **DO NOT allow the substance to warm up. Use a coolant agent such as dry ice or ice (wear thermal protective gloves). If this is not possible or none can be obtained, evacuate the area immediately.**
- ELIMINATE all ignition sources (no smoking, flares, sparks or flames) from immediate area.
- Keep combustibles (wood, paper, oil, etc.) away from spilled material.
- Do not touch or walk through spilled material.
- Stop leak if you can do it without risk.

Small Spill

- Pick up with inert, damp, non-combustible material using clean, non-sparking tools and place into loosely covered plastic containers for later disposal.

Large Spill

- Dike far ahead of liquid spill for later disposal.
- Prevent entry into waterways, sewers, basements or confined areas.
- **DO NOT CLEAN-UP OR DISPOSE OF, EXCEPT UNDER SUPERVISION OF A SPECIALIST.**

FIRST AID

- Call 911 or emergency medical service.
- Ensure that medical personnel are aware of the material(s) involved and take precautions to protect themselves.
- Move victim to fresh air if it can be done safely.
- Give artificial respiration if victim is not breathing.
- Administer oxygen if breathing is difficult.
- Remove and isolate contaminated clothing and shoes.
- Contaminated clothing may be a fire risk when dry.
- Remove material from skin immediately.
- In case of contact with substance, immediately flush skin or eyes with running water for at least 20 minutes.
- Keep victim calm and warm.

POTENTIAL HAZARDS

FIRE OR EXPLOSION

- **Self-decomposition, self-polymerization, or self-ignition may be triggered by heat, chemical reaction, friction or impact.**
- May be ignited by heat, sparks or flames.
- Some may decompose explosively when heated or involved in a fire.
- Those substances designated with a **(P)** may polymerize explosively when heated or involved in a fire.
- May burn violently. Decomposition or polymerization may be self-accelerating and produce large amounts of gases.
- Vapors or dust may form explosive mixtures with air.

HEALTH

- Inhalation or contact with vapors, substance or decomposition products may cause severe injury or death.
- May produce irritating, toxic and/or corrosive gases.
- Runoff from fire control or dilution water may cause environmental contamination.

PUBLIC SAFETY

- **CALL 911. Then call emergency response telephone number on shipping paper.** If shipping paper not available or no answer, refer to appropriate telephone number listed on the inside back cover.
- Keep unauthorized personnel away.
- Stay upwind, uphill and/or upstream.

PROTECTIVE CLOTHING

- Wear positive pressure self-contained breathing apparatus (SCBA).
- Wear chemical protective clothing that is specifically recommended by the manufacturer **when there is NO RISK OF FIRE.**
- Structural firefighters' protective clothing provides thermal protection **but only limited chemical protection.**

EVACUATION

Immediate precautionary measure

- Isolate spill or leak area in all directions for at least 50 meters (150 feet) for liquids and at least 25 meters (75 feet) for solids.

Large Spill

- Consider initial evacuation for at least 250 meters (800 feet) in all directions.

Fire

- If tank, rail car or tank truck is involved in a fire, ISOLATE for 800 meters (1/2 mile) in all directions; also, consider initial evacuation for 800 meters (1/2 mile) in all directions.



In Canada, an Emergency Response Assistance Plan (ERAP) may be required for this product. Please consult the shipping paper and/or the ERAP Program Section (page 390).

EMERGENCY RESPONSE**FIRE****Small Fire**

- Dry chemical, CO₂, water spray or regular foam.

Large Fire

- Flood fire area with water from a distance.
- If it can be done safely, move undamaged containers away from the area around the fire.

Fire Involving Tanks or Car/Trailer Loads

- **BEWARE OF POSSIBLE CONTAINER EXPLOSION.**
- Fight fire from maximum distance or use unmanned master stream devices or monitor nozzles.
- Cool containers with flooding quantities of water until well after fire is out.
- Withdraw immediately in case of rising sound from venting safety devices or discoloration of tank.
- **ALWAYS** stay away from tanks engulfed in fire.

SPILL OR LEAK

- **ELIMINATE** all ignition sources (no smoking, flares, sparks or flames) from immediate area.
- Do not touch or walk through spilled material.
- Stop leak if you can do it without risk.

Small Spill

- Pick up with inert, damp, non-combustible material using clean, non-sparking tools and place into loosely covered plastic containers for later disposal.
- Prevent entry into waterways, sewers, basements or confined areas.

FIRST AID

- Call 911 or emergency medical service.
- Ensure that medical personnel are aware of the material(s) involved and take precautions to protect themselves.
- Move victim to fresh air if it can be done safely.
- Give artificial respiration if victim is not breathing.
- Administer oxygen if breathing is difficult.
- Remove and isolate contaminated clothing and shoes.
- In case of contact with substance, immediately flush skin or eyes with running water for at least 20 minutes.
- Keep victim calm and warm.

POTENTIAL HAZARDS

FIRE OR EXPLOSION

- **Self-decomposition, self-polymerization, or self-ignition may be triggered by heat, chemical reaction, friction or impact.**
- Self-accelerating decomposition may occur if the specific control temperature is not maintained.
- These materials are particularly sensitive to temperature rises. Above a given "Control Temperature" they decompose or polymerize violently and may catch fire.
- May be ignited by heat, sparks or flames.
- Those substances designated with a **(P)** may polymerize explosively when heated or involved in a fire.
- Some may decompose explosively when heated or involved in a fire.
- May burn violently. Decomposition or polymerization may be self-accelerating and produce large amounts of gases.
- Vapors or dust may form explosive mixtures with air.

HEALTH

- Inhalation or contact with vapors, substance or decomposition products may cause severe injury or death.
- May produce irritating, toxic and/or corrosive gases.
- Runoff from fire control or dilution water may cause environmental contamination.

PUBLIC SAFETY

- **CALL 911. Then call emergency response telephone number on shipping paper.** If shipping paper not available or no answer, refer to appropriate telephone number listed on the inside back cover.
- Keep unauthorized personnel away.
- Stay upwind, uphill and/or upstream.

PROTECTIVE CLOTHING

- Wear positive pressure self-contained breathing apparatus (SCBA).
- Wear chemical protective clothing that is specifically recommended by the manufacturer **when there is NO RISK OF FIRE.**
- Structural firefighters' protective clothing provides thermal protection **but only limited chemical protection.**

EVACUATION

Immediate precautionary measure

- Isolate spill or leak area in all directions for at least 50 meters (150 feet) for liquids and at least 25 meters (75 feet) for solids.

Large Spill

- Consider initial evacuation for at least 250 meters (800 feet) in all directions.

Fire

- If tank, rail car or tank truck is involved in a fire, ISOLATE for 800 meters (1/2 mile) in all directions; also, consider initial evacuation for 800 meters (1/2 mile) in all directions.



In Canada, an Emergency Response Assistance Plan (ERAP) may be required for this product. Please consult the shipping paper and/or the ERAP Program Section (page 390).

EMERGENCY RESPONSE

FIRE

- The temperature of the substance must be maintained at or below the “Control Temperature” at all times.

Small Fire

- Dry chemical, CO₂, water spray or regular foam.

Large Fire

- Flood fire area with water from a distance.
- If it can be done safely, move undamaged containers away from the area around the fire.

Fire Involving Tanks or Car/Trailer Loads

- **BEWARE OF POSSIBLE CONTAINER EXPLOSION.**
- Fight fire from maximum distance or use unmanned master stream devices or monitor nozzles.
- Cool containers with flooding quantities of water until well after fire is out.
- Withdraw immediately in case of rising sound from venting safety devices or discoloration of tank.
- ALWAYS stay away from tanks engulfed in fire.

SPILL OR LEAK

- **DO NOT allow the substance to warm up. Use a coolant agent such as dry ice or ice (wear thermal protective gloves). If this is not possible or none can be obtained, evacuate the area immediately.**
- ELIMINATE all ignition sources (no smoking, flares, sparks or flames) from immediate area.
- Do not touch or walk through spilled material.
- Stop leak if you can do it without risk.

Small Spill

- Pick up with inert, damp, non-combustible material using clean, non-sparking tools and place into loosely covered plastic containers for later disposal.
- Prevent entry into waterways, sewers, basements or confined areas.
- **DO NOT CLEAN-UP OR DISPOSE OF, EXCEPT UNDER SUPERVISION OF A SPECIALIST.**

FIRST AID

- Call 911 or emergency medical service.
- Ensure that medical personnel are aware of the material(s) involved and take precautions to protect themselves.
- Move victim to fresh air if it can be done safely.
- Give artificial respiration if victim is not breathing.
- Administer oxygen if breathing is difficult.
- Remove and isolate contaminated clothing and shoes.
- In case of contact with substance, immediately flush skin or eyes with running water for at least 20 minutes.
- Keep victim calm and warm.

GUIDE SUBSTANCES - TOXIC (NON-COMBUSTIBLE)

151

POTENTIAL HAZARDS

HEALTH

- **Highly toxic**, may be fatal if inhaled, ingested or absorbed through skin.
- Avoid any skin contact.
- Effects of contact or inhalation may be delayed.
- Fire may produce irritating, corrosive and/or toxic gases.
- Runoff from fire control or dilution water may be corrosive and/or toxic and cause environmental contamination.

FIRE OR EXPLOSION

- Non-combustible, substance itself does not burn but may decompose upon heating to produce corrosive and/or toxic fumes.
- Containers may explode when heated.
- Runoff may pollute waterways.

PUBLIC SAFETY

- **CALL 911. Then call emergency response telephone number on shipping paper.** If shipping paper not available or no answer, refer to appropriate telephone number listed on the inside back cover.
- Keep unauthorized personnel away.
- Stay upwind, uphill and/or upstream.

PROTECTIVE CLOTHING

- Wear positive pressure self-contained breathing apparatus (SCBA).
- Wear chemical protective clothing that is specifically recommended by the manufacturer **when there is NO RISK OF FIRE.**
- Structural firefighters' protective clothing provides thermal protection **but only limited chemical protection.**

EVACUATION

Immediate precautionary measure

- Isolate spill or leak area in all directions for at least 50 meters (150 feet) for liquids and at least 25 meters (75 feet) for solids.

Spill

- For **highlighted materials**: see Table 1 - Initial Isolation and Protective Action Distances.
- For non-highlighted materials: increase the immediate precautionary measure distance, in the downwind direction, as necessary.

Fire

- If tank, rail car or tank truck is involved in a fire, ISOLATE for 800 meters (1/2 mile) in all directions; also, consider initial evacuation for 800 meters (1/2 mile) in all directions.



In Canada, an Emergency Response Assistance Plan (ERAP) may be required for this product. Please consult the shipping paper and/or the ERAP Program Section (page 390).

EMERGENCY RESPONSE**FIRE****Small Fire**

- Dry chemical, CO₂ or water spray.

Large Fire

- Water spray, fog or regular foam.
- If it can be done safely, move undamaged containers away from the area around the fire.
- Dike runoff from fire control for later disposal.
- Avoid aiming straight or solid streams directly onto the product.

Fire Involving Tanks or Car/Trailer Loads

- Fight fire from maximum distance or use unmanned master stream devices or monitor nozzles.
- Do not get water inside containers.
- Cool containers with flooding quantities of water until well after fire is out.
- Withdraw immediately in case of rising sound from venting safety devices or discoloration of tank.
- ALWAYS stay away from tanks engulfed in fire.
- For massive fire, use unmanned master stream devices or monitor nozzles; if this is impossible, withdraw from area and let fire burn.

SPILL OR LEAK

- Do not touch damaged containers or spilled material unless wearing appropriate protective clothing.
- Stop leak if you can do it without risk.
- Prevent entry into waterways, sewers, basements or confined areas.
- Cover with plastic sheet to prevent spreading.
- Absorb or cover with dry earth, sand or other non-combustible material and transfer to containers.
- DO NOT GET WATER INSIDE CONTAINERS.

FIRST AID

- Call 911 or emergency medical service.
- Ensure that medical personnel are aware of the material(s) involved and take precautions to protect themselves.
- Move victim to fresh air if it can be done safely.
- Give artificial respiration if victim is not breathing.
- **Do not perform mouth-to-mouth resuscitation if victim ingested or inhaled the substance; wash face and mouth before giving artificial respiration. Use a pocket mask equipped with a one-way valve or other proper respiratory medical device.**
- Administer oxygen if breathing is difficult.
- Remove and isolate contaminated clothing and shoes.
- In case of contact with substance, immediately flush skin or eyes with running water for at least 20 minutes.
- For minor skin contact, avoid spreading material on unaffected skin.
- Keep victim calm and warm.
- Effects of exposure (inhalation, ingestion or skin contact) to substance may be delayed.

GUIDE SUBSTANCES - TOXIC (COMBUSTIBLE)

152

POTENTIAL HAZARDS

HEALTH

- **Highly toxic**, may be fatal if inhaled, ingested or absorbed through skin.
- Contact with molten substance may cause severe burns to skin and eyes.
- Avoid any skin contact.
- Effects of contact or inhalation may be delayed.
- Fire may produce irritating, corrosive and/or toxic gases.
- Runoff from fire control or dilution water may be corrosive and/or toxic and cause environmental contamination.

FIRE OR EXPLOSION

- Combustible material: may burn but does not ignite readily.
- Containers may explode when heated.
- Runoff may pollute waterways.
- Substance may be transported in a molten form.

PUBLIC SAFETY

- **CALL 911. Then call emergency response telephone number on shipping paper.** If shipping paper not available or no answer, refer to appropriate telephone number listed on the inside back cover.
- Keep unauthorized personnel away.
- Stay upwind, uphill and/or upstream.

PROTECTIVE CLOTHING

- Wear positive pressure self-contained breathing apparatus (SCBA).
- Wear chemical protective clothing that is specifically recommended by the manufacturer **when there is NO RISK OF FIRE.**
- Structural firefighters' protective clothing provides thermal protection **but only limited chemical protection.**

EVACUATION

Immediate precautionary measure

- Isolate spill or leak area in all directions for at least 50 meters (150 feet) for liquids and at least 25 meters (75 feet) for solids.

Spill

- For **highlighted materials**: see Table 1 - Initial Isolation and Protective Action Distances.
- For non-highlighted materials: increase the immediate precautionary measure distance, in the downwind direction, as necessary.

Fire

- If tank, rail car or tank truck is involved in a fire, ISOLATE for 800 meters (1/2 mile) in all directions; also, consider initial evacuation for 800 meters (1/2 mile) in all directions.



In Canada, an Emergency Response Assistance Plan (ERAP) may be required for this product. Please consult the shipping paper and/or the ERAP Program Section (page 390).

EMERGENCY RESPONSE

FIRE

Small Fire

- Dry chemical, CO₂ or water spray.

Large Fire

- Water spray, fog or regular foam.
- If it can be done safely, move undamaged containers away from the area around the fire.
- Dike runoff from fire control for later disposal.
- Avoid aiming straight or solid streams directly onto the product.

Fire Involving Tanks or Car/Trailer Loads

- Fight fire from maximum distance or use unmanned master stream devices or monitor nozzles.
- Do not get water inside containers.
- Cool containers with flooding quantities of water until well after fire is out.
- Withdraw immediately in case of rising sound from venting safety devices or discoloration of tank.
- ALWAYS stay away from tanks engulfed in fire.
- For massive fire, use unmanned master stream devices or monitor nozzles; if this is impossible, withdraw from area and let fire burn.

SPILL OR LEAK

- ELIMINATE all ignition sources (no smoking, flares, sparks or flames) from immediate area.
- Do not touch damaged containers or spilled material unless wearing appropriate protective clothing.
- Stop leak if you can do it without risk.
- Prevent entry into waterways, sewers, basements or confined areas.
- Cover with plastic sheet to prevent spreading.
- Absorb or cover with dry earth, sand or other non-combustible material and transfer to containers.
- DO NOT GET WATER INSIDE CONTAINERS.

FIRST AID

- Call 911 or emergency medical service.
- Ensure that medical personnel are aware of the material(s) involved and take precautions to protect themselves.
- Move victim to fresh air if it can be done safely.
- Give artificial respiration if victim is not breathing.
- **Do not perform mouth-to-mouth resuscitation if victim ingested or inhaled the substance; wash face and mouth before giving artificial respiration. Use a pocket mask equipped with a one-way valve or other proper respiratory medical device.**
- Administer oxygen if breathing is difficult.
- Remove and isolate contaminated clothing and shoes.
- In case of contact with substance, immediately flush skin or eyes with running water for at least 20 minutes.
- For minor skin contact, avoid spreading material on unaffected skin.
- Keep victim calm and warm.
- Effects of exposure (inhalation, ingestion or skin contact) to substance may be delayed.

POTENTIAL HAZARDS

HEALTH

- **TOXIC**; inhalation, ingestion or skin contact with material may cause severe injury or death.
- Contact with molten substance may cause severe burns to skin and eyes.
- Avoid any skin contact.
- Effects of contact or inhalation may be delayed.
- Fire may produce irritating, corrosive and/or toxic gases.
- Runoff from fire control or dilution water may be corrosive and/or toxic and cause environmental contamination.

FIRE OR EXPLOSION

- Combustible material: may burn but does not ignite readily.
- When heated, vapors may form explosive mixtures with air: indoors, outdoors and sewers explosion hazards.
- Those substances designated with a **(P)** may polymerize explosively when heated or involved in a fire.
- Contact with metals may evolve flammable hydrogen gas.
- Containers may explode when heated.
- Runoff may pollute waterways.
- Substance may be transported in a molten form.

PUBLIC SAFETY

- **CALL 911. Then call emergency response telephone number on shipping paper.** If shipping paper not available or no answer, refer to appropriate telephone number listed on the inside back cover.
- Keep unauthorized personnel away.
- Stay upwind, uphill and/or upstream.
- Ventilate closed spaces before entering, but only if properly trained and equipped.

PROTECTIVE CLOTHING

- Wear positive pressure self-contained breathing apparatus (SCBA).
- Wear chemical protective clothing that is specifically recommended by the manufacturer **when there is NO RISK OF FIRE.**
- Structural firefighters' protective clothing provides thermal protection **but only limited chemical protection.**

EVACUATION

Immediate precautionary measure

- Isolate spill or leak area in all directions for at least 50 meters (150 feet) for liquids and at least 25 meters (75 feet) for solids.

Spill

- For **highlighted materials**: see Table 1 - Initial Isolation and Protective Action Distances.
- For non-highlighted materials: increase the immediate precautionary measure distance, in the downwind direction, as necessary.

Fire

- If tank, rail car or tank truck is involved in a fire, ISOLATE for 800 meters (1/2 mile) in all directions; also, consider initial evacuation for 800 meters (1/2 mile) in all directions.



In Canada, an Emergency Response Assistance Plan (ERAP) may be required for this product. Please consult the shipping paper and/or the ERAP Program Section (page 390).

EMERGENCY RESPONSE

FIRE

Small Fire

- Dry chemical, CO₂ or water spray.

Large Fire

- Dry chemical, CO₂, alcohol-resistant foam or water spray.
- If it can be done safely, move undamaged containers away from the area around the fire.
- Dike runoff from fire control for later disposal.

Fire Involving Tanks or Car/Trailer Loads

- Fight fire from maximum distance or use unmanned master stream devices or monitor nozzles.
- Do not get water inside containers.
- Cool containers with flooding quantities of water until well after fire is out.
- Withdraw immediately in case of rising sound from venting safety devices or discoloration of tank.
- ALWAYS stay away from tanks engulfed in fire.

SPILL OR LEAK

- ELIMINATE all ignition sources (no smoking, flares, sparks or flames) from immediate area.
- Do not touch damaged containers or spilled material unless wearing appropriate protective clothing.
- Stop leak if you can do it without risk.
- Prevent entry into waterways, sewers, basements or confined areas.
- Absorb or cover with dry earth, sand or other non-combustible material and transfer to containers.
- DO NOT GET WATER INSIDE CONTAINERS.

FIRST AID

- Call 911 or emergency medical service.
- Ensure that medical personnel are aware of the material(s) involved and take precautions to protect themselves.
- Move victim to fresh air if it can be done safely.
- Give artificial respiration if victim is not breathing.
- **Do not perform mouth-to-mouth resuscitation if victim ingested or inhaled the substance; wash face and mouth before giving artificial respiration. Use a pocket mask equipped with a one-way valve or other proper respiratory medical device.**
- Administer oxygen if breathing is difficult.
- Remove and isolate contaminated clothing and shoes.
- In case of contact with substance, immediately flush skin or eyes with running water for at least 20 minutes.
- For minor skin contact, avoid spreading material on unaffected skin.
- Keep victim calm and warm.
- Effects of exposure (inhalation, ingestion or skin contact) to substance may be delayed.

GUIDE SUBSTANCES - TOXIC AND/OR CORROSIVE 154 (NON-COMBUSTIBLE)

POTENTIAL HAZARDS

HEALTH

- **TOXIC**; inhalation, ingestion or skin contact with material may cause severe injury or death.
- Contact with molten substance may cause severe burns to skin and eyes.
- Avoid any skin contact.
- Effects of contact or inhalation may be delayed.
- Fire may produce irritating, corrosive and/or toxic gases.
- Runoff from fire control or dilution water may be corrosive and/or toxic and cause environmental contamination.

FIRE OR EXPLOSION

- Non-combustible, substance itself does not burn but may decompose upon heating to produce corrosive and/or toxic fumes.
- Some are oxidizers and may ignite combustibles (wood, paper, oil, clothing, etc.).
- Contact with metals may evolve flammable hydrogen gas.
- Containers may explode when heated.
- For electric vehicles or equipment, GUIDE 147 (lithium ion batteries) or GUIDE 138 (sodium batteries) should also be consulted.

PUBLIC SAFETY

- **CALL 911. Then call emergency response telephone number on shipping paper.** If shipping paper not available or no answer, refer to appropriate telephone number listed on the inside back cover.
- Keep unauthorized personnel away.
- Stay upwind, uphill and/or upstream.
- Ventilate closed spaces before entering, but only if properly trained and equipped.

PROTECTIVE CLOTHING

- Wear positive pressure self-contained breathing apparatus (SCBA).
- Wear chemical protective clothing that is specifically recommended by the manufacturer **when there is NO RISK OF FIRE.**
- Structural firefighters' protective clothing provides thermal protection **but only limited chemical protection.**

EVACUATION

Immediate precautionary measure

- Isolate spill or leak area in all directions for at least 50 meters (150 feet) for liquids and at least 25 meters (75 feet) for solids.

Spill

- For **highlighted materials**: see Table 1 - Initial Isolation and Protective Action Distances.
- For non-highlighted materials: increase the immediate precautionary measure distance, in the downwind direction, as necessary.

Fire

- If tank, rail car or tank truck is involved in a fire, ISOLATE for 800 meters (1/2 mile) in all directions; also, consider initial evacuation for 800 meters (1/2 mile) in all directions.



In Canada, an Emergency Response Assistance Plan (ERAP) may be required for this product. Please consult the shipping paper and/or the ERAP Program Section (page 390).

EMERGENCY RESPONSE

FIRE**Small Fire**

- Dry chemical, CO₂ or water spray.

Large Fire

- Dry chemical, CO₂, alcohol-resistant foam or water spray.
- If it can be done safely, move undamaged containers away from the area around the fire.
- Dike runoff from fire control for later disposal.

Fire Involving Tanks or Car/Trailer Loads

- Fight fire from maximum distance or use unmanned master stream devices or monitor nozzles.
- Do not get water inside containers.
- Cool containers with flooding quantities of water until well after fire is out.
- Withdraw immediately in case of rising sound from venting safety devices or discoloration of tank.
- ALWAYS stay away from tanks engulfed in fire.

SPILL OR LEAK

- ELIMINATE all ignition sources (no smoking, flares, sparks or flames) from immediate area.
- Do not touch damaged containers or spilled material unless wearing appropriate protective clothing.
- Stop leak if you can do it without risk.
- Prevent entry into waterways, sewers, basements or confined areas.
- Absorb or cover with dry earth, sand or other non-combustible material and transfer to containers.
- DO NOT GET WATER INSIDE CONTAINERS.

FIRST AID

- Call 911 or emergency medical service.
- Ensure that medical personnel are aware of the material(s) involved and take precautions to protect themselves.
- Move victim to fresh air if it can be done safely.
- Give artificial respiration if victim is not breathing.
- **Do not perform mouth-to-mouth resuscitation if victim ingested or inhaled the substance; wash face and mouth before giving artificial respiration. Use a pocket mask equipped with a one-way valve or other proper respiratory medical device.**
- Administer oxygen if breathing is difficult.
- Remove and isolate contaminated clothing and shoes.
- In case of contact with substance, immediately flush skin or eyes with running water for at least 20 minutes.
- For minor skin contact, avoid spreading material on unaffected skin.
- Keep victim calm and warm.
- Effects of exposure (inhalation, ingestion or skin contact) to substance may be delayed.

POTENTIAL HAZARDS

FIRE OR EXPLOSION

- **HIGHLY FLAMMABLE: Will be easily ignited by heat, sparks or flames.**
- Vapors form explosive mixtures with air: indoors, outdoors and sewers explosion hazards.
- Most vapors are heavier than air. They will spread along the ground and collect in low or confined areas (sewers, basements, tanks, etc.).
- Vapors may travel to source of ignition and flash back.
- Those substances designated with a **(P)** may polymerize explosively when heated or involved in a fire.
- Substance will react with water (some violently) releasing flammable, toxic or corrosive gases and runoff.
- Contact with metals may evolve flammable hydrogen gas.
- Containers may explode when heated or if contaminated with water.

HEALTH

- **TOXIC;** inhalation, ingestion or contact (skin, eyes) with vapors, dusts or substance may cause severe injury, burns or death.
- **Bromoacetates and chloroacetates are extremely irritating/lachrymators (cause eye irritation and flow of tears).**
- Reaction with water or moist air will release toxic, corrosive or flammable gases.
- Reaction with water may generate much heat that will increase the concentration of fumes in the air.
- Fire will produce irritating, corrosive and/or toxic gases.
- Runoff from fire control or dilution water may be corrosive and/or toxic and cause environmental contamination.

PUBLIC SAFETY

- **CALL 911. Then call emergency response telephone number on shipping paper.** If shipping paper not available or no answer, refer to appropriate telephone number listed on the inside back cover.
- Keep unauthorized personnel away.
- Stay upwind, uphill and/or upstream.
- Ventilate closed spaces before entering, but only if properly trained and equipped.

PROTECTIVE CLOTHING

- Wear positive pressure self-contained breathing apparatus (SCBA).
- Wear chemical protective clothing that is specifically recommended by the manufacturer **when there is NO RISK OF FIRE.**
- Structural firefighters' protective clothing provides thermal protection **but only limited chemical protection.**

EVACUATION

Immediate precautionary measure

- Isolate spill or leak area in all directions for at least 50 meters (150 feet) for liquids and at least 25 meters (75 feet) for solids.

Spill

- For **highlighted materials**: see Table 1 - Initial Isolation and Protective Action Distances.
- For non-highlighted materials: increase the immediate precautionary measure distance, in the downwind direction, as necessary.

Fire

- If tank, rail car or tank truck is involved in a fire, ISOLATE for 800 meters (1/2 mile) in all directions; also, consider initial evacuation for 800 meters (1/2 mile) in all directions.



In Canada, an Emergency Response Assistance Plan (ERAP) may be required for this product. Please consult the shipping paper and/or the ERAP Program Section (page 390).

EMERGENCY RESPONSE

FIRE

- Note: Most foams will react with the material and release corrosive/toxic gases.

CAUTION: For Acetyl chloride (UN1717), use CO₂ or dry chemical only.

Small Fire

- CO₂, dry chemical, dry sand, alcohol-resistant foam.

Large Fire

- Water spray, fog or alcohol-resistant foam.
- **FOR CHLOROSILANES, DO NOT USE WATER;** use AFFF alcohol-resistant medium-expansion foam.
- If it can be done safely, move undamaged containers away from the area around the fire.
- Avoid aiming straight or solid streams directly onto the product.

Fire Involving Tanks or Car/Trailer Loads

- Fight fire from maximum distance or use unmanned master stream devices or monitor nozzles.
- Do not get water inside containers.
- Cool containers with flooding quantities of water until well after fire is out.
- Withdraw immediately in case of rising sound from venting safety devices or discoloration of tank.
- ALWAYS stay away from tanks engulfed in fire.

SPILL OR LEAK

- ELIMINATE all ignition sources (no smoking, flares, sparks or flames) from immediate area.
- All equipment used when handling the product must be grounded.
- Do not touch damaged containers or spilled material unless wearing appropriate protective clothing.
- Stop leak if you can do it without risk.
- A vapor-suppressing foam may be used to reduce vapors.
- **FOR CHLOROSILANES,** use AFFF alcohol-resistant medium-expansion foam to reduce vapors.
- **DO NOT GET WATER on spilled substance or inside containers.**
- Use water spray to reduce vapors or divert vapor cloud drift. Avoid allowing water runoff to contact spilled material.
- Prevent entry into waterways, sewers, basements or confined areas.

Small Spill

- Cover with DRY earth, DRY sand or other non-combustible material followed with plastic sheet to minimize spreading or contact with rain.
- Use clean, non-sparking tools to collect material and place it into loosely covered plastic containers for later disposal.

FIRST AID

- Call 911 or emergency medical service.
- Ensure that medical personnel are aware of the material(s) involved and take precautions to protect themselves.
- Move victim to fresh air if it can be done safely.
- Give artificial respiration if victim is not breathing.
- **Do not perform mouth-to-mouth resuscitation if victim ingested or inhaled the substance; wash face and mouth before giving artificial respiration. Use a pocket mask equipped with a one-way valve or other proper respiratory medical device.**
- Administer oxygen if breathing is difficult.
- Remove and isolate contaminated clothing and shoes.
- In case of contact with substance, immediately flush skin or eyes with running water for at least 20 minutes.
- For minor skin contact, avoid spreading material on unaffected skin.
- Keep victim calm and warm.
- Effects of exposure (inhalation, ingestion or skin contact) to substance may be delayed.

GUIDE SUBSTANCES - TOXIC AND/OR CORROSIVE 156 (COMBUSTIBLE/WATER-SENSITIVE)

POTENTIAL HAZARDS

FIRE OR EXPLOSION

- Combustible material: may burn but does not ignite readily.
- Substance will react with water (some violently) releasing flammable, toxic or corrosive gases and runoff.
- When heated, vapors may form explosive mixtures with air: indoors, outdoors and sewers explosion hazards.
- Most vapors are heavier than air. They will spread along the ground and collect in low or confined areas (sewers, basements, tanks, etc.).
- Vapors may travel to source of ignition and flash back.
- Contact with metals may evolve flammable hydrogen gas.
- Containers may explode when heated or if contaminated with water.

HEALTH

- **TOXIC**; inhalation, ingestion or contact (skin, eyes) with vapors, dusts or substance may cause severe injury, burns or death.
- Contact with molten substance may cause severe burns to skin and eyes.
- Reaction with water or moist air will release toxic, corrosive or flammable gases.
- Reaction with water may generate much heat that will increase the concentration of fumes in the air.
- Fire will produce irritating, corrosive and/or toxic gases.
- Runoff from fire control or dilution water may be corrosive and/or toxic and cause environmental contamination.

PUBLIC SAFETY

- **CALL 911. Then call emergency response telephone number on shipping paper.** If shipping paper not available or no answer, refer to appropriate telephone number listed on the inside back cover.
- Keep unauthorized personnel away.
- Stay upwind, uphill and/or upstream.
- Ventilate closed spaces before entering, but only if properly trained and equipped.

PROTECTIVE CLOTHING

- Wear positive pressure self-contained breathing apparatus (SCBA).
- Wear chemical protective clothing that is specifically recommended by the manufacturer **when there is NO RISK OF FIRE.**
- Structural firefighters' protective clothing provides thermal protection **but only limited chemical protection.**

EVACUATION

Immediate precautionary measure

- Isolate spill or leak area in all directions for at least 50 meters (150 feet) for liquids and at least 25 meters (75 feet) for solids.

Spill

- For **highlighted materials**: see Table 1 - Initial Isolation and Protective Action Distances.
- For non-highlighted materials: increase the immediate precautionary measure distance, in the downwind direction, as necessary.

Fire

- If tank, rail car or tank truck is involved in a fire, ISOLATE for 800 meters (1/2 mile) in all directions; also, consider initial evacuation for 800 meters (1/2 mile) in all directions.



In Canada, an Emergency Response Assistance Plan (ERAP) may be required for this product. Please consult the shipping paper and/or the ERAP Program Section (page 390).

EMERGENCY RESPONSE

FIRE

- Note: Most foams will react with the material and release corrosive/toxic gases.

Small Fire

- CO₂, dry chemical, dry sand, alcohol-resistant foam.

Large Fire

- Water spray, fog or alcohol-resistant foam.
- **FOR CHLOROSILANES, DO NOT USE WATER;** use AFFF alcohol-resistant medium-expansion foam.
- If it can be done safely, move undamaged containers away from the area around the fire.
- Avoid aiming straight or solid streams directly onto the product.

Fire Involving Tanks or Car/Trailer Loads

- Fight fire from maximum distance or use unmanned master stream devices or monitor nozzles.
- Do not get water inside containers.
- Cool containers with flooding quantities of water until well after fire is out.
- Withdraw immediately in case of rising sound from venting safety devices or discoloration of tank.
- ALWAYS stay away from tanks engulfed in fire.

SPILL OR LEAK

- ELIMINATE all ignition sources (no smoking, flares, sparks or flames) from immediate area.
- All equipment used when handling the product must be grounded.
- Do not touch damaged containers or spilled material unless wearing appropriate protective clothing.
- Stop leak if you can do it without risk.
- A vapor-suppressing foam may be used to reduce vapors.
- **FOR CHLOROSILANES,** use AFFF alcohol-resistant medium-expansion foam to reduce vapors.
- **DO NOT GET WATER on spilled substance or inside containers.**
- Use water spray to reduce vapors or divert vapor cloud drift. Avoid allowing water runoff to contact spilled material.
- Prevent entry into waterways, sewers, basements or confined areas.

Small Spill

- Cover with DRY earth, DRY sand or other non-combustible material followed with plastic sheet to minimize spreading or contact with rain.
- Use clean, non-sparking tools to collect material and place it into loosely covered plastic containers for later disposal.

FIRST AID

- Call 911 or emergency medical service.
- Ensure that medical personnel are aware of the material(s) involved and take precautions to protect themselves.
- Move victim to fresh air if it can be done safely.
- Give artificial respiration if victim is not breathing.
- **Do not perform mouth-to-mouth resuscitation if victim ingested or inhaled the substance; wash face and mouth before giving artificial respiration. Use a pocket mask equipped with a one-way valve or other proper respiratory medical device.**
- Administer oxygen if breathing is difficult.
- Remove and isolate contaminated clothing and shoes.
- In case of contact with substance, immediately flush skin or eyes with running water for at least 20 minutes.
- For minor skin contact, avoid spreading material on unaffected skin.
- Keep victim calm and warm.
- Effects of exposure (inhalation, ingestion or skin contact) to substance may be delayed.

GUIDE SUBSTANCES - TOXIC AND/OR CORROSIVE 157 (NON-COMBUSTIBLE/WATER-SENSITIVE)

POTENTIAL HAZARDS

HEALTH

- **TOXIC**; inhalation, ingestion or contact (skin, eyes) with vapors, dusts or substance may cause severe injury, burns or death.
- Reaction with water or moist air may release toxic, corrosive or flammable gases.
- Reaction with water may generate much heat that will increase the concentration of fumes in the air.
- Fire will produce irritating, corrosive and/or toxic gases.
- Runoff from fire control or dilution water may be corrosive and/or toxic and cause environmental contamination.

FIRE OR EXPLOSION

- Non-combustible, substance itself does not burn but may decompose upon heating to produce corrosive and/or toxic fumes.
- UN1796, UN1802, UN1826, UN2032, UN3084, UN3085, and, at concentrations above 65%, UN2031 may act as oxidizers. Also consult GUIDE 140.
- Vapors may accumulate in confined areas (basement, tanks, hopper/tank cars, etc.).
- Substance may react with water (some violently), releasing corrosive and/or toxic gases and runoff.
- Contact with metals may evolve flammable hydrogen gas.
- Containers may explode when heated or if contaminated with water.

PUBLIC SAFETY

- **CALL 911. Then call emergency response telephone number on shipping paper.** If shipping paper not available or no answer, refer to appropriate telephone number listed on the inside back cover.
- Keep unauthorized personnel away.
- Stay upwind, uphill and/or upstream.
- Ventilate closed spaces before entering, but only if properly trained and equipped.

PROTECTIVE CLOTHING

- Wear positive pressure self-contained breathing apparatus (SCBA).
- Wear chemical protective clothing that is specifically recommended by the manufacturer **when there is NO RISK OF FIRE.**
- Structural firefighters' protective clothing provides thermal protection **but only limited chemical protection.**

EVACUATION

Immediate precautionary measure

- Isolate spill or leak area in all directions for at least 50 meters (150 feet) for liquids and at least 25 meters (75 feet) for solids.

Spill

- For **highlighted materials**: see Table 1 - Initial Isolation and Protective Action Distances.
- For non-highlighted materials: increase the immediate precautionary measure distance, in the downwind direction, as necessary.

Fire

- If tank, rail car or tank truck is involved in a fire, ISOLATE for 800 meters (1/2 mile) in all directions; also, consider initial evacuation for 800 meters (1/2 mile) in all directions.



In Canada, an Emergency Response Assistance Plan (ERAP) may be required for this product. Please consult the shipping paper and/or the ERAP Program Section (page 390).

EMERGENCY RESPONSE

FIRE

- Note: Some foams will react with the material and release corrosive/toxic gases.

Small Fire

- CO₂ (except for Cyanides), dry chemical, dry sand, alcohol-resistant foam.

Large Fire

- Water spray, fog or alcohol-resistant foam.
- If it can be done safely, move undamaged containers away from the area around the fire.
- Avoid aiming straight or solid streams directly onto the product.
- Dike runoff from fire control for later disposal.

Fire Involving Tanks or Car/Trailer Loads

- Fight fire from maximum distance or use unmanned master stream devices or monitor nozzles.
- Do not get water inside containers.
- Cool containers with flooding quantities of water until well after fire is out.
- Withdraw immediately in case of rising sound from venting safety devices or discoloration of tank.
- ALWAYS stay away from tanks engulfed in fire.

SPILL OR LEAK

- ELIMINATE all ignition sources (no smoking, flares, sparks or flames) from immediate area.
- All equipment used when handling the product must be grounded.
- Do not touch damaged containers or spilled material unless wearing appropriate protective clothing.
- Stop leak if you can do it without risk.
- A vapor-suppressing foam may be used to reduce vapors.
- DO NOT GET WATER INSIDE CONTAINERS.
- Use water spray to reduce vapors or divert vapor cloud drift. Avoid allowing water runoff to contact spilled material.
- Prevent entry into waterways, sewers, basements or confined areas.

Small Spill

- Cover with DRY earth, DRY sand or other non-combustible material followed with plastic sheet to minimize spreading or contact with rain.
- Use clean, non-sparking tools to collect material and place it into loosely covered plastic containers for later disposal.

FIRST AID

- Call 911 or emergency medical service.
- Ensure that medical personnel are aware of the material(s) involved and take precautions to protect themselves.
- Move victim to fresh air if it can be done safely.
- Give artificial respiration if victim is not breathing.
- **Do not perform mouth-to-mouth resuscitation if victim ingested or inhaled the substance; wash face and mouth before giving artificial respiration. Use a pocket mask equipped with a one-way valve or other proper respiratory medical device.**
- Administer oxygen if breathing is difficult.
- Remove and isolate contaminated clothing and shoes.
- In case of contact with substance, immediately flush skin or eyes with running water for at least 20 minutes.
- **In case of skin contact with Hydrofluoric acid (UN1790)**, if calcium gluconate gel is available, rinse 5 minutes, then apply gel. Otherwise, continue rinsing until medical treatment is available.
- For minor skin contact, avoid spreading material on unaffected skin.
- Keep victim calm and warm.
- Effects of exposure (inhalation, ingestion or skin contact) to substance may be delayed.

POTENTIAL HAZARDS

HEALTH

- Inhalation or contact with substance may cause infection, disease or death.
- Category A Infectious Substances (UN2814, UN2900 or UN3549) are more hazardous, or are in a more hazardous form, than infectious substances shipped as Category B Biological Substances (UN3373) or clinical waste/medical waste (UN3291).
- Runoff from fire control or dilution water may cause environmental contamination.
- Damaged packages containing solid CO₂ as a refrigerant may produce water or frost from condensation of air. Do not touch this liquid as it could be contaminated by the contents of the parcel.
- Contact with solid CO₂ may cause burns, severe injury and/or frostbite.

FIRE OR EXPLOSION

- Some of these materials may burn, but none ignite readily.
- Some may be transported in flammable liquids.

PUBLIC SAFETY

- **CALL 911. Then call emergency response telephone number on shipping paper.** If shipping paper not available or no answer, refer to appropriate telephone number listed on the inside back cover.
- Keep unauthorized personnel away.
- Stay upwind, uphill and/or upstream.
- Consult the shipping paper to identify the substance involved.

PROTECTIVE CLOTHING

- Use judgement based on the amount of material present and the possible routes of exposure to select protective clothing.
- Wear appropriate respiratory protection, such as fit-tested N95 respirator (at minimum), powered air purifying respirator (PAPR), or positive pressure self-contained breathing apparatus (SCBA).
- Wear full coverage body protection (e.g., Tyvek suit), faceshield, and disposable fluid-resistant gloves (e.g., latex or nitrile).
- Wear appropriate footwear; disposable shoe covers can be worn to protect against contamination.
- Puncture- and cut-resistant gloves should be worn over fluid-resistant gloves if sharp objects (e.g., broken glass, needles) are present.
- Wear insulated gloves (e.g. cryo gloves) over fluid-resistant gloves when handling dry ice (UN1845).
- Decontaminate protective clothing and personal protective equipment after use and before cleaning or disposal with a compatible chemical disinfectant (e.g., 10% solution of bleach, equivalent to 0.5% sodium hypochlorite) or through a validated decontamination technology (e.g., autoclave) or process.
- Structural firefighters' protective clothing provides thermal protection **but only limited chemical protection.**
- For more information on decontamination, consult p. 362

EVACUATION

Immediate precautionary measure

- Isolate spill or leak area for at least 25 meters (75 feet) in all directions.



In Canada, an Emergency Response Assistance Plan (ERAP) may be required for this product. Please consult the shipping paper and/or the ERAP Program Section (page 390).

EMERGENCY RESPONSE

FIRE

Small Fire

- Dry chemical, soda ash, lime or sand.

Large Fire

- Use extinguishing agent suitable for type of surrounding fire.
- Do not scatter spilled material with high-pressure water streams.
- If it can be done safely, move undamaged containers away from the area around the fire.

SPILL OR LEAK

- Do not touch or walk through spilled material.
- Do not touch damaged containers or spilled material unless wearing appropriate protective clothing.
- Absorb with earth, sand or other non-combustible material.
- Cover damaged package or spilled material with absorbent material such as paper towel, towel or rag to absorb any liquids, and, beginning from outside edge, pour liquid bleach or other chemical disinfectant to saturate. Keep wet with liquid bleach or other disinfectant.
- **DO NOT CLEAN-UP OR DISPOSE OF, EXCEPT UNDER SUPERVISION OF A SPECIALIST.**

FIRST AID

- Call 911 or emergency medical service.
- Ensure that medical personnel are aware of the material(s) involved and take precautions to protect themselves.
- Move victim to a safe isolated area if it can be done safely.

CAUTION: Victim may be a source of contamination.

- Remove and isolate contaminated clothing and shoes.
- In case of contact with substance, immediately flush eyes with running water and wash skin with soap and water for at least 20 minutes. Take caution not to break the skin.
- Effects of exposure (inhalation, ingestion, injection/inoculation or skin contact) to substance may be delayed. Victim should consult medical professional for information regarding symptoms and treatment.
- **For further assistance, contact your local Poison Control Center.**

GUIDE SUBSTANCES (IRRITATING)

159

POTENTIAL HAZARDS

HEALTH

- Inhalation of vapors or dust is extremely irritating.
- May cause burning of eyes and lachrymation (flow of tears).
- May cause coughing, difficult breathing and nausea.
- Brief exposure effects last only a few minutes.
- Exposure in an enclosed area may be very harmful.
- Fire will produce irritating, corrosive and/or toxic gases.
- Runoff from fire control or dilution water may cause environmental contamination.

FIRE OR EXPLOSION

- Some of these materials may burn, but none ignite readily.
- Containers may explode when heated.

PUBLIC SAFETY

- **CALL 911. Then call emergency response telephone number on shipping paper.** If shipping paper not available or no answer, refer to appropriate telephone number listed on the inside back cover.
- Keep unauthorized personnel away.
- Stay upwind, uphill and/or upstream.
- Ventilate closed spaces before entering, but only if properly trained and equipped.

PROTECTIVE CLOTHING

- Wear positive pressure self-contained breathing apparatus (SCBA).
- Wear chemical protective clothing that is specifically recommended by the manufacturer **when there is NO RISK OF FIRE.**
- Structural firefighters' protective clothing provides thermal protection **but only limited chemical protection.**

EVACUATION

Immediate precautionary measure

- Isolate spill or leak area in all directions for at least 50 meters (150 feet) for liquids and at least 25 meters (75 feet) for solids.

Spill

- For **highlighted materials**: see Table 1 - Initial Isolation and Protective Action Distances.
- For non-highlighted materials: increase the immediate precautionary measure distance, in the downwind direction, as necessary.

Fire

- If tank, rail car or tank truck is involved in a fire, ISOLATE for 800 meters (1/2 mile) in all directions; also, consider initial evacuation for 800 meters (1/2 mile) in all directions.



In Canada, an Emergency Response Assistance Plan (ERAP) may be required for this product. Please consult the shipping paper and/or the ERAP Program Section (page 390).

EMERGENCY RESPONSE

FIRE

Small Fire

- Dry chemical, CO₂, water spray or regular foam.

Large Fire

- Water spray, fog or regular foam.
- If it can be done safely, move undamaged containers away from the area around the fire.
- Dike runoff from fire control for later disposal.

Fire Involving Tanks or Car/Trailer Loads

- Fight fire from maximum distance or use unmanned master stream devices or monitor nozzles.
- Do not get water inside containers.
- Cool containers with flooding quantities of water until well after fire is out.
- Withdraw immediately in case of rising sound from venting safety devices or discoloration of tank.
- ALWAYS stay away from tanks engulfed in fire.
- For massive fire, use unmanned master stream devices or monitor nozzles; if this is impossible, withdraw from area and let fire burn.

SPILL OR LEAK

- Do not touch or walk through spilled material.
- Stop leak if you can do it without risk.

Small Spill

- Pick up with sand or other non-combustible absorbent material and place into containers for later disposal.

Large Spill

- Dike far ahead of liquid spill for later disposal.
- Prevent entry into waterways, sewers, basements or confined areas.

FIRST AID

- Call 911 or emergency medical service.
- Ensure that medical personnel are aware of the material(s) involved and take precautions to protect themselves.
- Move victim to fresh air if it can be done safely.
- Give artificial respiration if victim is not breathing.
- **Do not perform mouth-to-mouth resuscitation if victim ingested or inhaled the substance; wash face and mouth before giving artificial respiration. Use a pocket mask equipped with a one-way valve or other proper respiratory medical device.**
- Administer oxygen if breathing is difficult.
- Remove and isolate contaminated clothing and shoes.
- In case of contact with substance, immediately flush skin or eyes with running water for at least 20 minutes.
- For minor skin contact, avoid spreading material on unaffected skin.
- Keep victim calm and warm.
- Effects should disappear after individual has been exposed to fresh air for approximately 10 minutes.

POTENTIAL HAZARDS

HEALTH

- Toxic by ingestion.
- Vapors may cause dizziness or asphyxiation.
- Exposure in an enclosed area may be very harmful.
- Contact may irritate or burn skin and eyes.
- Fire may produce irritating and/or toxic gases.
- Runoff from fire control or dilution water may cause environmental contamination.

FIRE OR EXPLOSION

- Some of these materials may burn, but none ignite readily.
- Most vapors are heavier than air.
- Air/vapor mixtures may explode when ignited.
- Container may explode in heat of fire.

PUBLIC SAFETY

- **CALL 911. Then call emergency response telephone number on shipping paper.** If shipping paper not available or no answer, refer to appropriate telephone number listed on the inside back cover.
- Keep unauthorized personnel away.
- Stay upwind, uphill and/or upstream.
- Many gases are heavier than air and will spread along the ground and collect in low or confined areas (sewers, basements, tanks, etc.).
- Ventilate closed spaces before entering, but only if properly trained and equipped.

PROTECTIVE CLOTHING

- Wear positive pressure self-contained breathing apparatus (SCBA).
- Wear chemical protective clothing that is specifically recommended by the manufacturer **when there is NO RISK OF FIRE.**
- Structural firefighters' protective clothing provides thermal protection **but only limited chemical protection.**

EVACUATION

Immediate precautionary measure

- Isolate spill or leak area for at least 50 meters (150 feet) in all directions.

Large Spill

- Consider initial downwind evacuation for at least 100 meters (330 feet).

Fire

- If tank, rail car or tank truck is involved in a fire, ISOLATE for 800 meters (1/2 mile) in all directions; also, consider initial evacuation for 800 meters (1/2 mile) in all directions.

EMERGENCY RESPONSE

FIRE

Small Fire

- Dry chemical, CO₂ or water spray.

Large Fire

- Dry chemical, CO₂, alcohol-resistant foam or water spray.
- If it can be done safely, move undamaged containers away from the area around the fire.
- Dike runoff from fire control for later disposal.

Fire Involving Tanks or Car/Trailer Loads

- Fight fire from maximum distance or use unmanned master stream devices or monitor nozzles.
- Cool containers with flooding quantities of water until well after fire is out.
- Withdraw immediately in case of rising sound from venting safety devices or discoloration of tank.
- ALWAYS stay away from tanks engulfed in fire.

SPILL OR LEAK

- ELIMINATE all ignition sources (no smoking, flares, sparks or flames) from immediate area.
- Stop leak if you can do it without risk.

Small Liquid Spill

- Pick up with sand, earth or other non-combustible absorbent material.

Large Spill

- Dike far ahead of liquid spill for later disposal.
- Prevent entry into waterways, sewers, basements or confined areas.

FIRST AID

- Call 911 or emergency medical service.
- Ensure that medical personnel are aware of the material(s) involved and take precautions to protect themselves.
- Move victim to fresh air if it can be done safely.
- Give artificial respiration if victim is not breathing.
- Administer oxygen if breathing is difficult.
- Remove and isolate contaminated clothing and shoes.
- In case of contact with substance, immediately flush skin or eyes with running water for at least 20 minutes.
- For minor skin contact, avoid spreading material on unaffected skin.
- Wash skin with soap and water.
- Keep victim calm and warm.

GUIDE 161

RADIOACTIVE MATERIALS (LOW LEVEL RADIATION)

POTENTIAL HAZARDS

HEALTH

- Radiation presents minimal risk to transport workers, emergency response personnel and the public during transportation accidents. Packaging durability increases as potential hazard of radioactive content increases.
- Very low levels of contained radioactive materials and low radiation levels outside packages result in low risks to people. Damaged packages may release measurable amounts of radioactive material, but the resulting risks are expected to be low.
- Some radioactive materials cannot be detected by commonly available instruments.
- Packages do not have RADIOACTIVE I, II, or III labels. Some may have EMPTY labels or may have the word "Radioactive" in the package marking.

FIRE OR EXPLOSION

- Some of these materials may burn, but most do not ignite readily.
- Many have cardboard outer packaging; content (physically large or small) can be of many different physical forms.
- Radioactivity does not change flammability or other properties of materials.

PUBLIC SAFETY

- **CALL 911. Then call emergency response telephone number on shipping paper.** If shipping paper not available or no answer, refer to appropriate telephone number listed on the inside back cover.
- **Priorities for rescue, life-saving, first aid, fire control and other hazards are higher than the priority for measuring radiation levels.**
- Radiation Authority must be notified of accident conditions. Radiation Authority is usually responsible for decisions about radiological consequences and closure of emergencies.
- Stay upwind, uphill and/or upstream.
- Keep unauthorized personnel away.
- Detain or isolate uninjured persons or equipment suspected to be contaminated; delay decontamination and cleanup until instructions are received from Radiation Authority.

PROTECTIVE CLOTHING

- Positive pressure self-contained breathing apparatus (SCBA) and structural firefighters' protective clothing will provide adequate protection.

EVACUATION

Immediate precautionary measure

- Isolate spill or leak area for at least 25 meters (75 feet) in all directions.

Large Spill

- Consider initial downwind evacuation for at least 100 meters (330 feet).

Fire

- When a large quantity of this material is involved in a major fire, consider an initial evacuation distance of 300 meters (1000 feet) in all directions.

EMERGENCY RESPONSE

FIRE

- Presence of radioactive material will not influence the fire control processes and should not influence selection of techniques.
- If it can be done safely, move undamaged containers away from the area around the fire.
- Do not move damaged packages; move undamaged packages out of fire zone.

Small Fire

- Dry chemical, CO₂, water spray or regular foam.

Large Fire

- Water spray, fog (flooding amounts).

SPILL OR LEAK

- Do not touch damaged packages or spilled material.
- Cover liquid spill with sand, earth or other non-combustible absorbent material.
- Cover powder spill with plastic sheet or tarp to minimize spreading.

FIRST AID

- Call 911 or emergency medical service.
- Ensure that medical personnel are aware of the material(s) involved and take precautions to protect themselves.
- Medical problems take priority over radiological concerns.
- Use first aid treatment according to the nature of the injury.
- Do not delay care and transport of a seriously injured person.
- Give artificial respiration if victim is not breathing.
- Administer oxygen if breathing is difficult.
- In case of contact with substance, immediately flush skin or eyes with running water for at least 20 minutes.
- Injured persons contaminated by contact with released material are not a serious hazard to health care personnel, equipment or facilities.

GUIDE RADIOACTIVE MATERIALS 162 (LOW TO MODERATE LEVEL RADIATION)

POTENTIAL HAZARDS

HEALTH

- Radiation presents minimal risk to transport workers, emergency response personnel and the public during transportation accidents. Packaging durability increases as potential hazard of radioactive content increases.
- Undamaged packages are safe. Contents of damaged packages may cause higher external radiation exposure, or both external and internal radiation exposure if contents are released.
- Low radiation hazard when material is inside container. If material is released from package or bulk container, hazard will vary from low to moderate. Level of hazard will depend on the type and amount of radioactivity, the kind of material it is in, and/or the surfaces it is on.
- Some material may be released from packages during accidents of moderate severity but risks to people are not great.
- Released radioactive materials or contaminated objects usually will be visible if packaging fails.
- Some exclusive use shipments of bulk and packaged materials will not have "RADIOACTIVE" labels. Placards, markings and shipping papers provide identification.
- Some packages may have a "RADIOACTIVE" label and a second hazard label. The second hazard is usually greater than the radiation hazard; so follow this GUIDE as well as the response GUIDE for the second hazard class label.
- Some radioactive materials cannot be detected by commonly available instruments.
- Runoff from control of cargo fire may cause low-level pollution.

FIRE OR EXPLOSION

- Some of these materials may burn, but most do not ignite readily.
- Uranium and Thorium metal cuttings may ignite spontaneously if exposed to air (see GUIDE 136).
- Nitrates are oxidizers and may ignite other combustibles (see GUIDE 141).

PUBLIC SAFETY

- **CALL 911. Then call emergency response telephone number on shipping paper.** If shipping paper not available or no answer, refer to appropriate telephone number listed on the inside back cover.
- **Priorities for rescue, life-saving, first aid, fire control and other hazards are higher than the priority for measuring radiation levels.**
- Radiation Authority must be notified of accident conditions. Radiation Authority is usually responsible for decisions about radiological consequences and closure of emergencies.
- Stay upwind, uphill and/or upstream.
- Keep unauthorized personnel away.
- Detain or isolate uninjured persons or equipment suspected to be contaminated; delay decontamination and cleanup until instructions are received from Radiation Authority.

PROTECTIVE CLOTHING

- Positive pressure self-contained breathing apparatus (SCBA) and structural firefighters' protective clothing will provide adequate protection.

EVACUATION

Immediate precautionary measure

- Isolate spill or leak area for at least 25 meters (75 feet) in all directions.

Large Spill

- Consider initial downwind evacuation for at least 100 meters (330 feet).

Fire

- When a large quantity of this material is involved in a major fire, consider an initial evacuation distance of 300 meters (1000 feet) in all directions.



In Canada, an Emergency Response Assistance Plan (ERAP) may be required for this product. Please consult the shipping paper and/or the ERAP Program Section (page 390).

EMERGENCY RESPONSE

FIRE

- Presence of radioactive material will not influence the fire control processes and should not influence selection of techniques.
- If it can be done safely, move undamaged containers away from the area around the fire.
- Do not move damaged packages; move undamaged packages out of fire zone.

Small Fire

- Dry chemical, CO₂, water spray or regular foam.

Large Fire

- Water spray, fog (flooding amounts).
- Dike runoff from fire control for later disposal.

SPILL OR LEAK

- Do not touch damaged packages or spilled material.
- Cover liquid spill with sand, earth or other non-combustible absorbent material.
- Dike to collect large liquid spills.
- Cover powder spill with plastic sheet or tarp to minimize spreading.

FIRST AID

- Call 911 or emergency medical service.
- Ensure that medical personnel are aware of the material(s) involved and take precautions to protect themselves.
- Medical problems take priority over radiological concerns.
- Use first aid treatment according to the nature of the injury.
- Do not delay care and transport of a seriously injured person.
- Give artificial respiration if victim is not breathing.
- Administer oxygen if breathing is difficult.
- In case of contact with substance, wipe from skin immediately; flush skin or eyes with running water for at least 20 minutes.
- Injured persons contaminated by contact with released material are not a serious hazard to health care personnel, equipment or facilities.

GUIDE 163 RADIOACTIVE MATERIALS (LOW TO HIGH LEVEL RADIATION)

POTENTIAL HAZARDS

HEALTH

- Radiation presents minimal risk to transport workers, emergency response personnel and the public during transportation accidents. Packaging durability increases as potential hazard of radioactive content increases.
- Undamaged packages are safe. Contents of damaged packages may cause higher external radiation exposure, or both external and internal radiation exposure if contents are released.
- Type A packages (cartons, boxes, drums, articles, etc.) identified as "Type A" by marking on packages or by shipping papers contain non-life-endangering amounts. Partial releases might be expected if "Type A" packages are damaged in moderately severe accidents.
- Type B packages, and the rarely occurring Type C packages (large and small, usually metal), contain the most hazardous amounts. They can be identified by package markings or by shipping papers. Life-threatening conditions may exist only if contents are released or package shielding fails. Because of design, evaluation and testing of packages, these conditions would be expected only for accidents of utmost severity.
- The rarely occurring "Special Arrangement" shipments may be of Type A, Type B or Type C packages. Package type will be marked on packages, and shipment details will be on shipping papers.
- Radioactive White-I labels indicate radiation levels outside single, isolated, undamaged packages are very low (less than 0.005 mSv/h (0.5 mrem/h)).
- Radioactive Yellow-II and Yellow-III labeled packages have higher radiation levels. The transport index (TI) on the label identifies the maximum radiation level in mrem/h one meter from a single, isolated, undamaged package.
- Some radioactive materials cannot be detected by commonly available instruments.
- Water from cargo fire control may cause pollution.

FIRE OR EXPLOSION

- Some of these materials may burn, but most do not ignite readily.
- Radioactivity does not change flammability or other properties of materials.
- Type B packages are designed and evaluated to withstand total engulfment in flames at temperatures of 800°C (1475°F) for a period of 30 minutes.

PUBLIC SAFETY

- **CALL 911. Then call emergency response telephone number on shipping paper.** If shipping paper not available or no answer, refer to appropriate telephone number listed on the inside back cover.
- **Priorities for rescue, life-saving, first aid, fire control and other hazards are higher than the priority for measuring radiation levels.**
- Radiation Authority must be notified of accident conditions. Radiation Authority is usually responsible for decisions about radiological consequences and closure of emergencies.
- Stay upwind, uphill and/or upstream. • Keep unauthorized personnel away.
- Detain or isolate uninjured persons or equipment suspected to be contaminated; delay decontamination and cleanup until instructions are received from Radiation Authority.

PROTECTIVE CLOTHING

- Positive pressure self-contained breathing apparatus (SCBA) and structural firefighters' protective clothing will provide adequate protection against internal radiation exposure, but not external radiation exposure.

EVACUATION

Immediate precautionary measure

- Isolate spill or leak area for at least 25 meters (75 feet) in all directions.

Large Spill

- Consider initial downwind evacuation for at least 100 meters (330 feet).

Fire

- When a large quantity of this material is involved in a major fire, consider an initial evacuation distance of 300 meters (1000 feet) in all directions.

EMERGENCY RESPONSE

FIRE

- Presence of radioactive material will not influence the fire control processes and should not influence selection of techniques.
- If it can be done safely, move undamaged containers away from the area around the fire.
- Do not move damaged packages; move undamaged packages out of fire zone.

Small Fire

- Dry chemical, CO₂, water spray or regular foam.

Large Fire

- Water spray, fog (flooding amounts).
- Dike runoff from fire control for later disposal.

SPILL OR LEAK

- Do not touch damaged packages or spilled material.
- Damp surfaces on undamaged or slightly damaged packages are seldom an indication of packaging failure. Most packaging for liquid content have inner containers and/or inner absorbent materials.
- Cover liquid spill with sand, earth or other non-combustible absorbent material.

FIRST AID

- Call 911 or emergency medical service.
- Ensure that medical personnel are aware of the material(s) involved and take precautions to protect themselves.
- Medical problems take priority over radiological concerns.
- Use first aid treatment according to the nature of the injury.
- Do not delay care and transport of a seriously injured person.
- Give artificial respiration if victim is not breathing.
- Administer oxygen if breathing is difficult.
- In case of contact with substance, immediately flush skin or eyes with running water for at least 20 minutes.
- Injured persons contaminated by contact with released material are not a serious hazard to health care personnel, equipment or facilities.

GUIDE 164 RADIOACTIVE MATERIALS (SPECIAL FORM/ LOW TO HIGH LEVEL EXTERNAL RADIATION)

POTENTIAL HAZARDS

HEALTH

- Radiation presents minimal risk to transport workers, emergency response personnel and the public during transportation accidents. Packaging durability increases as potential hazard of radioactive content increases.
- Undamaged packages are safe; contents of damaged packages may cause external radiation exposure, and much higher external exposure if contents (source capsules) are released.
- Contamination and internal radiation hazards are not expected, but not impossible.
- Type A packages (cartons, boxes, drums, articles, etc.) identified as "Type A" by marking on packages or by shipping papers contain non-life-endangering amounts. Radioactive sources may be released if "Type A" packages are damaged in moderately severe accidents.
- Type B packages, and the rarely occurring Type C packages, (large and small, usually metal) contain the most hazardous amounts. They can be identified by package markings or by shipping papers. Life-threatening conditions may exist only if contents are released or package shielding fails. Because of design, evaluation and testing of packages, these conditions would be expected only for accidents of utmost severity.
- Radioactive White-I labels indicate radiation levels outside single, isolated, undamaged packages are very low (less than 0.005 mSv/h (0.5 mrem/h)).
- Radioactive Yellow-II and Yellow-III labeled packages have higher radiation levels. The transport index (TI) on the label identifies the maximum radiation level in mrem/h one meter from a single, isolated, undamaged package.
- Radiation from the package contents, usually in durable metal capsules, can be detected by most radiation instruments.
- Water from cargo fire control is not expected to cause pollution.

FIRE OR EXPLOSION

- Packagings can burn completely without risk of content loss from sealed source capsule.
- Radioactivity does not change flammability or other properties of materials.
- Radioactive source capsules and Type B packages are designed and evaluated to withstand total engulfment in flames at temperatures of 800°C (1475°F) for a period of 30 minutes.

PUBLIC SAFETY

- **CALL 911. Then call emergency response telephone number on shipping paper.** If shipping paper not available or no answer, refer to appropriate telephone number listed on the inside back cover.
- **Priorities for rescue, life-saving, first aid, fire control and other hazards are higher than the priority for measuring radiation levels.**
- Radiation Authority must be notified of accident conditions. Radiation Authority is usually responsible for decisions about radiological consequences and closure of emergencies.
- Stay upwind, uphill and/or upstream. • Keep unauthorized personnel away.
- Delay final cleanup until instructions or advice is received from Radiation Authority.

PROTECTIVE CLOTHING

- Positive pressure self-contained breathing apparatus (SCBA) and structural firefighters' protective clothing will provide adequate protection against internal radiation exposure, but not external radiation exposure.

EVACUATION

Immediate precautionary measure

- Isolate spill or leak area for at least 25 meters (75 feet) in all directions.

Large Spill

- Consider initial downwind evacuation for at least 100 meters (330 feet).

Fire

- When a large quantity of this material is involved in a major fire, consider an initial evacuation distance of 300 meters (1000 feet) in all directions.

EMERGENCY RESPONSE

FIRE

- Presence of radioactive material will not influence the fire control processes and should not influence selection of techniques.
- If it can be done safely, move undamaged containers away from the area around the fire.
- Do not move damaged packages; move undamaged packages out of fire zone.

Small Fire

- Dry chemical, CO₂, water spray or regular foam.

Large Fire

- Water spray, fog (flooding amounts).

SPILL OR LEAK

- Do not touch damaged packages or spilled material.
- Damp surfaces on undamaged or slightly damaged packages are seldom an indication of packaging failure. Contents are seldom liquid. Content is usually a metal capsule, easily seen if released from package.
- If source capsule is identified as being out of package, **DO NOT TOUCH**. Stay away and await advice from Radiation Authority.

FIRST AID

- Call 911 or emergency medical service.
- Ensure that medical personnel are aware of the material(s) involved and take precautions to protect themselves.
- Medical problems take priority over radiological concerns.
- Use first aid treatment according to the nature of the injury.
- Do not delay care and transport of a seriously injured person.
- Persons exposed to special form sources are not likely to be contaminated with radioactive material.
- Give artificial respiration if victim is not breathing.
- Administer oxygen if breathing is difficult.
- Injured persons contaminated by contact with released material are not a serious hazard to health care personnel, equipment or facilities.

GUIDE RADIOACTIVE MATERIALS 165 (FISSILE/LOW TO HIGH LEVEL RADIATION)

POTENTIAL HAZARDS

HEALTH

- Radiation presents minimal risk to transport workers, emergency response personnel and the public during transportation accidents. Packaging durability increases as potential radiation and criticality hazards of the content increase.
- Undamaged packages are safe. Contents of damaged packages may cause higher external radiation exposure, or both external and internal radiation exposure if contents are released.
- Type AF or IF packages, identified by package markings, do not contain life-threatening amounts of material. External radiation levels are low and packages are designed, evaluated and tested to control releases and to prevent a fission chain reaction under severe transport conditions.
- Type B(U)F, B(M)F and CF packages (identified by markings on packages or shipping papers) contain potentially life-endangering amounts. Because of design, evaluation and testing of packages, fission chain reactions are prevented and releases are not expected to be life-endangering for all accidents except those of utmost severity.
- The rarely occurring "Special Arrangement" shipments may be of Type AF, BF or CF packages. Package type will be marked on packages, and shipment details will be on shipping papers.
- The transport index (TI) shown on labels or a shipping paper might not indicate the radiation level at one meter from a single, isolated, undamaged package; instead, it might relate to controls needed during transport because of the fissile properties of the materials. Alternatively, the fissile nature of the contents may be indicated by a criticality safety index (CSI) on a special FISSILE label or on the shipping paper.
- Some radioactive materials cannot be detected by commonly available instruments.
- Water from cargo fire control is not expected to cause pollution.

FIRE OR EXPLOSION

- These materials are seldom flammable. Packages are designed to withstand fires without damage to contents.
- Radioactivity does not change flammability or other properties of materials.
- Type AF, IF, B(U)F, B(M)F and CF packages are designed and evaluated to withstand total engulfment in flames at temperatures of 800°C (1475°F) for a period of 30 minutes.

PUBLIC SAFETY

- **CALL 911. Then call emergency response telephone number on shipping paper.** If shipping paper not available or no answer, refer to appropriate telephone number listed on the inside back cover.
- **Priorities for rescue, life-saving, first aid, fire control and other hazards are higher than the priority for measuring radiation levels.** • Radiation Authority must be notified of accident conditions. Radiation Authority is usually responsible for decisions about radiological consequences and closure of emergencies.
- Stay upwind, uphill and/or upstream. • Keep unauthorized personnel away.
- Detain or isolate uninjured persons or equipment suspected to be contaminated; delay decontamination and cleanup until instructions are received from Radiation Authority.

PROTECTIVE CLOTHING

- Positive pressure self-contained breathing apparatus (SCBA) and structural firefighters' protective clothing will provide adequate protection against internal radiation exposure, but not external radiation exposure.

EVACUATION

Immediate precautionary measure

- Isolate spill or leak area for at least 25 meters (75 feet) in all directions.

Large Spill

- Consider initial downwind evacuation for at least 100 meters (330 feet).

Fire

- When a large quantity of this material is involved in a major fire, consider an initial evacuation distance of 300 meters (1000 feet) in all directions.



In Canada, an Emergency Response Assistance Plan (ERAP) may be required for this product. Please consult the shipping paper and/or the ERAP Program Section (page 390).

EMERGENCY RESPONSE

FIRE

- Presence of radioactive material will not influence the fire control processes and should not influence selection of techniques.
- If it can be done safely, move undamaged containers away from the area around the fire.
- Do not move damaged packages; move undamaged packages out of fire zone.

Small Fire

- Dry chemical, CO₂, water spray or regular foam.

Large Fire

- Water spray, fog (flooding amounts).

SPILL OR LEAK

- Do not touch damaged packages or spilled material.
- Damp surfaces on undamaged or slightly damaged packages are seldom an indication of packaging failure. Most packaging for liquid content have inner containers and/or inner absorbent materials.

Liquid Spill

- Package contents are seldom liquid. If any radioactive contamination resulting from a liquid release is present, it probably will be low-level.

FIRST AID

- Call 911 or emergency medical service.
- Ensure that medical personnel are aware of the material(s) involved and take precautions to protect themselves.
- Medical problems take priority over radiological concerns.
- Use first aid treatment according to the nature of the injury.
- Do not delay care and transport of a seriously injured person.
- Give artificial respiration if victim is not breathing.
- Administer oxygen if breathing is difficult.
- In case of contact with substance, immediately flush skin or eyes with running water for at least 20 minutes.
- Injured persons contaminated by contact with released material are not a serious hazard to health care personnel, equipment or facilities.

GUIDE 166 RADIOACTIVE MATERIALS - CORROSIVE (URANIUM HEXAFLUORIDE/WATER-SENSITIVE)

POTENTIAL HAZARDS

HEALTH

- Radiation presents minimal risk to transport workers, emergency response personnel and the public during transportation accidents. Packaging durability increases as potential radiation and criticality hazards of the content increase.
- **Chemical hazard greatly exceeds radiation hazard.**
- Substance reacts with water and water vapor in air to form **toxic and corrosive hydrogen fluoride gas, hydrofluoric acid**, and an extremely irritating and corrosive, white-colored, water-soluble residue.
- If inhaled, may be fatal. • Direct contact causes burns to skin, eyes, and respiratory tract.
- Low-level radioactive material; very low radiation hazard to people.
- Runoff from control of cargo fire may cause low-level pollution.

FIRE OR EXPLOSION

- Substance does not burn. • The material may react violently with fuels.
- Product will decompose to produce toxic and/or corrosive fumes.
- Containers in protective overpacks (horizontal cylindrical shape with short legs for tie-downs), are identified with "AF", "B(U)F" or "H(U)" on shipping papers or by markings on the overpacks. They are designed and evaluated to withstand severe conditions including total engulfment in flames at temperatures of 800°C (1475°F) for a period of 30 minutes.
- Bare filled cylinders, identified with UN2978 as part of the marking (may also be marked H(U) or H(M)), may rupture in heat of engulfing fire; bare empty (except for residue) cylinders will not rupture in fires.
- Radioactivity does not change flammability or other properties of materials.

PUBLIC SAFETY

- **CALL 911. Then call emergency response telephone number on shipping paper.** If shipping paper not available or no answer, refer to appropriate telephone number listed on the inside back cover.
- **Priorities for rescue, life-saving, first aid, fire control and other hazards are higher than the priority for measuring radiation levels.**
- Radiation Authority must be notified of accident conditions. Radiation Authority is usually responsible for decisions about radiological consequences and closure of emergencies.
- Stay upwind, uphill and/or upstream. • Keep unauthorized personnel away.
- Detain or isolate uninjured persons or equipment suspected to be contaminated; delay decontamination and cleanup until instructions are received from Radiation Authority.

PROTECTIVE CLOTHING

- Wear positive pressure self-contained breathing apparatus (SCBA).
- Wear chemical protective clothing that is specifically recommended by the manufacturer **when there is NO RISK OF FIRE.**
- Structural firefighters' protective clothing provides thermal protection **but only limited chemical protection.**

EVACUATION

Immediate precautionary measure

- Isolate spill or leak area for at least 25 meters (75 feet) in all directions.

Spill

- See [Table 1 - Initial Isolation and Protective Action Distances](#).

Fire

- When a large quantity of this material is involved in a major fire, consider an initial evacuation distance of 300 meters (1000 feet) in all directions.



In Canada, an Emergency Response Assistance Plan (ERAP) may be required for this product. Please consult the shipping paper and/or the ERAP Program Section (page 390).

EMERGENCY RESPONSE

FIRE

- DO NOT USE WATER OR FOAM ON MATERIAL ITSELF.
- If it can be done safely, move undamaged containers away from the area around the fire.

Small Fire

- Dry chemical or CO₂.

Large Fire

- Water spray, fog or regular foam.
- Cool containers with flooding quantities of water until well after fire is out.
- If this is impossible, withdraw from area and let fire burn.
- ALWAYS stay away from tanks engulfed in fire.

SPILL OR LEAK

- Do not touch damaged packages or spilled material.
- DO NOT GET WATER INSIDE CONTAINERS.
- Without fire or smoke, leak will be evident by visible and irritating vapors and residue forming at the point of release.
- Use fine water spray to reduce vapors; do not put water directly on point of material release from container.
- Residue buildup may self-seal small leaks.
- Dike far ahead of spill to collect runoff water.

FIRST AID

- Call 911 or emergency medical service.
- Ensure that medical personnel are aware of the material(s) involved and take precautions to protect themselves.
- Medical problems take priority over radiological concerns.
- Use first aid treatment according to the nature of the injury.
- **In case of skin contact with hydrogen fluoride gas and/or Hydrofluoric acid**, if calcium gluconate gel is available, rinse 5 minutes, then apply gel. Otherwise, continue rinsing until medical treatment is available.
- Do not delay care and transport of a seriously injured person.
- Give artificial respiration if victim is not breathing.
- Administer oxygen if breathing is difficult.
- In case of contact with substance, immediately flush skin or eyes with running water for at least 20 minutes.
- Effects of exposure (inhalation, ingestion or skin contact) to substance may be delayed.
- Keep victim calm and warm.

Page intentionally left blank

There are no materials that refer to this guide.

Page intentionally left blank

There are no materials that refer to this guide.

GUIDE CARBON MONOXIDE (REFRIGERATED LIQUID)

168

POTENTIAL HAZARDS

HEALTH

- **TOXIC; Extremely Hazardous.**
- Inhalation extremely dangerous; may be fatal.
- Contact with gas or liquefied gas may cause burns, severe injury and/or frostbite.
- Odorless, will not be detected by sense of smell.

FIRE OR EXPLOSION

- **EXTREMELY FLAMMABLE.**

CAUTION: Flame can be invisible. Use an alternate method of detection (thermal camera, broom handle, etc.)

- May be ignited by heat, sparks or flames.
- Containers may explode when heated.
- Vapor explosion and poison hazard indoors, outdoors or in sewers.
- Vapors from liquefied gas are initially heavier than air and spread along ground.
- Vapors may travel to source of ignition and flash back.
- Runoff may create fire or explosion hazard.

PUBLIC SAFETY

- **CALL 911. Then call emergency response telephone number on shipping paper.** If shipping paper not available or no answer, refer to appropriate telephone number listed on the inside back cover.
- Keep unauthorized personnel away.
- Stay upwind, uphill and/or upstream.
- Many gases are heavier than air and will spread along the ground and collect in low or confined areas (sewers, basements, tanks, etc.).
- Ventilate closed spaces before entering, but only if properly trained and equipped.

PROTECTIVE CLOTHING

- Wear positive pressure self-contained breathing apparatus (SCBA).
- Wear chemical protective clothing that is specifically recommended by the manufacturer **when there is NO RISK OF FIRE.**
- Structural firefighters' protective clothing provides thermal protection **but only limited chemical protection.**
- Always wear thermal protective clothing when handling refrigerated/cryogenic liquids.

EVACUATION

Immediate precautionary measure

- Isolate spill or leak area for at least 100 meters (330 feet) in all directions.

Spill

- See [Table 1 - Initial Isolation and Protective Action Distances](#).

Fire

- If tank, rail car or tank truck is involved in a fire, ISOLATE for 800 meters (1/2 mile) in all directions; also, consider initial evacuation for 800 meters (1/2 mile) in all directions.

EMERGENCY RESPONSE**FIRE**

CAUTION: Flame can be invisible. Use an alternate method of detection (thermal camera, broom handle, etc.)

- **DO NOT EXTINGUISH A LEAKING GAS FIRE UNLESS LEAK CAN BE STOPPED.**

Small Fire

- Dry chemical, CO₂ or water spray.

Large Fire

- Water spray, fog or regular foam.
- If it can be done safely, move undamaged containers away from the area around the fire.

Fire Involving Tanks

- Fight fire from maximum distance or use unmanned master stream devices or monitor nozzles.
- Cool containers with flooding quantities of water until well after fire is out.
- Do not direct water at source of leak or safety devices; icing may occur.
- Withdraw immediately in case of rising sound from venting safety devices or discoloration of tank.
- ALWAYS stay away from tanks engulfed in fire.

SPILL OR LEAK

- ELIMINATE all ignition sources (no smoking, flares, sparks or flames) from immediate area.
- All equipment used when handling the product must be grounded.
- Do not touch or walk through spilled material.
- Stop leak if you can do it without risk.
- Use water spray to reduce vapors or divert vapor cloud drift. Avoid allowing water runoff to contact spilled material.
- Do not direct water at spill or source of leak.
- If possible, turn leaking containers so that gas escapes rather than liquid.
- Prevent entry into waterways, sewers, basements or confined areas.
- Isolate area until gas has dispersed.

FIRST AID

- Call 911 or emergency medical service.
- Ensure that medical personnel are aware of the material(s) involved and take precautions to protect themselves.
- Move victim to fresh air if it can be done safely.
- Give artificial respiration if victim is not breathing.
- Administer oxygen if breathing is difficult.
- Remove and isolate contaminated clothing and shoes.
- In case of contact with substance, immediately flush skin or eyes with running water for at least 20 minutes.
- In case of contact with liquefied gas, thaw frosted parts with lukewarm water.
- Keep victim calm and warm.
- Keep victim under observation.
- Effects of contact or inhalation may be delayed.

GUIDE ALUMINUM (MOLTEN)

169

POTENTIAL HAZARDS

FIRE OR EXPLOSION

- Substance is transported in molten form at a temperature above 705°C (1300°F).
- Violent reaction with water; contact may cause an explosion or may produce a flammable gas.
- Will ignite combustible materials (wood, paper, oil, debris, etc.).
- Contact with nitrates or other oxidizers may cause an explosion.
- Contact with containers or other materials, including cold, wet or dirty tools, may cause an explosion.
- Contact with concrete will cause spalling and small pops.

HEALTH

- Contact causes severe burns to skin and eyes.
- Fire may produce irritating and/or toxic gases.

PUBLIC SAFETY

- **CALL 911. Then call emergency response telephone number on shipping paper.** If shipping paper not available or no answer, refer to appropriate telephone number listed on the inside back cover.
- Stay upwind, uphill and/or upstream.
- Keep unauthorized personnel away.
- Ventilate closed spaces before entering, but only if properly trained and equipped.

PROTECTIVE CLOTHING

- Wear positive pressure self-contained breathing apparatus (SCBA).
- Wear flame-retardant structural firefighters' protective clothing, including faceshield, helmet and gloves, as this will provide limited thermal protection.

EVACUATION

Immediate precautionary measure

- Isolate spill or leak area for at least 50 meters (150 feet) in all directions.

EMERGENCY RESPONSE

FIRE

- Do not use water, except in life-threatening situations and then only in a fine spray.
- Do not use halogenated extinguishing agents or foam.
- Move combustibles out of path of advancing pool if you can do so without risk.
- Extinguish fires started by molten material by using appropriate method for the burning material; keep water, halogenated extinguishing agents and foam away from the molten material.

SPILL OR LEAK

- Do not touch or walk through spilled material.
- Do not attempt to stop leak, due to danger of explosion.
- Keep combustibles (wood, paper, oil, etc.) away from spilled material.
- Substance is very fluid, spreads quickly, and may splash. Do not try to stop it with shovels or other objects.
- Dike far ahead of spill; use dry sand to contain the flow of material.
- Where possible allow molten material to solidify naturally.
- Avoid contact even after material solidifies. Molten, heated and cold aluminum look alike; do not touch unless you know it is cold.
- Clean up under the supervision of an expert after material has solidified.

FIRST AID

- Call 911 or emergency medical service.
- Ensure that medical personnel are aware of the material(s) involved and take precautions to protect themselves.
- Move victim to fresh air if it can be done safely.
- Give artificial respiration if victim is not breathing.
- Administer oxygen if breathing is difficult.
- For severe burns, immediate medical attention is required.
- Removal of solidified molten material from skin requires medical assistance.
- Remove and isolate contaminated clothing and shoes.
- In case of contact with substance, immediately flush skin or eyes with running water for at least 20 minutes.
- Keep victim calm and warm.

GUIDE METALS (POWDERS, DUSTS, SHAVINGS, BORINGS, TURNINGS, OR CUTTINGS, ETC.)

170

POTENTIAL HAZARDS

FIRE OR EXPLOSION

- May react violently or explosively on contact with water.
- Some are transported in flammable liquids.
- May be ignited by friction, heat, sparks or flames.
- Some of these materials will burn with intense heat.
- Dusts or fumes may form explosive mixtures in air.
- Containers may explode when heated.
- May re-ignite after fire is extinguished.

HEALTH

- Oxides from metallic fires are a severe health hazard.
- Inhalation or contact with substance or decomposition products may cause severe injury or death.
- Fire may produce irritating, corrosive and/or toxic gases.
- Runoff from fire control or dilution water may cause environmental contamination.

PUBLIC SAFETY

- **CALL 911. Then call emergency response telephone number on shipping paper.** If shipping paper not available or no answer, refer to appropriate telephone number listed on the inside back cover.
- Stay upwind, uphill and/or upstream.
- Keep unauthorized personnel away.

PROTECTIVE CLOTHING

- Wear positive pressure self-contained breathing apparatus (SCBA).
- Structural firefighters' protective clothing provides thermal protection **but only limited chemical protection.**

EVACUATION

Immediate precautionary measure

- Isolate spill or leak area in all directions for at least 50 meters (150 feet) for liquids and at least 25 meters (75 feet) for solids.

Large Spill

- Consider initial downwind evacuation for at least 50 meters (160 feet).

Fire

- If tank, rail car or tank truck is involved in a fire, ISOLATE for 800 meters (1/2 mile) in all directions; also, consider initial evacuation for 800 meters (1/2 mile) in all directions.



In Canada, an Emergency Response Assistance Plan (ERAP) may be required for this product. Please consult the shipping paper and/or the ERAP Program Section (page 390).

EMERGENCY RESPONSE

FIRE

- **DO NOT USE WATER, FOAM OR CO₂.**
- Dousing metallic fires with water will generate hydrogen gas, an extremely dangerous explosion hazard, particularly if fire is in a confined environment (i.e., building, cargo hold, etc.).
- Use DRY sand, graphite powder, dry sodium chloride-based extinguishers, or class D extinguishers.
- Confining and smothering metal fires is preferable rather than applying water.
- If it can be done safely, move undamaged containers away from the area around the fire.

Fire Involving Tanks or Car/Trailer Loads

- If impossible to extinguish, protect surroundings and allow fire to burn itself out.

SPILL OR LEAK

- ELIMINATE all ignition sources (no smoking, flares, sparks or flames) from immediate area.
- Do not touch or walk through spilled material.
- Stop leak if you can do it without risk.
- Prevent entry into waterways, sewers, basements or confined areas.

FIRST AID

- Call 911 or emergency medical service.
- Ensure that medical personnel are aware of the material(s) involved and take precautions to protect themselves.
- Move victim to fresh air if it can be done safely.
- Give artificial respiration if victim is not breathing.
- Administer oxygen if breathing is difficult.
- Remove and isolate contaminated clothing and shoes.
- In case of contact with substance, immediately flush skin or eyes with running water for at least 20 minutes.
- Keep victim calm and warm.

GUIDE SUBSTANCES (LOW TO MODERATE HAZARD)

171

POTENTIAL HAZARDS

FIRE OR EXPLOSION

- Some may burn but none ignite readily.
- Containers may explode when heated.
- Some may be transported hot.
- For UN3508, Capacitor, asymmetric, be aware of possible short circuiting as this product is transported in a charged state.
- Polymeric beads, expandable (UN2211) may evolve flammable vapours.

HEALTH

- Inhalation of material may be harmful.
- Contact may cause burns to skin and eyes.
- Inhalation of Asbestos dust may have a damaging effect on the lungs.
- Fire may produce irritating, corrosive and/or toxic gases.
- Some liquids produce vapors that may cause dizziness or asphyxiation.
- Runoff from fire control or dilution water may cause environmental contamination.

PUBLIC SAFETY

- **CALL 911. Then call emergency response telephone number on shipping paper.** If shipping paper not available or no answer, refer to appropriate telephone number listed on the inside back cover.
- Keep unauthorized personnel away.
- Stay upwind, uphill and/or upstream.

PROTECTIVE CLOTHING

- Wear positive pressure self-contained breathing apparatus (SCBA).
- Structural firefighters' protective clothing provides thermal protection **but only limited chemical protection.**

EVACUATION

Immediate precautionary measure

- Isolate spill or leak area in all directions for at least 50 meters (150 feet) for liquids and at least 25 meters (75 feet) for solids.

Spill

- For **highlighted materials**: see Table 1 - Initial Isolation and Protective Action Distances.
- For non-highlighted materials: increase the immediate precautionary measure distance, in the downwind direction, as necessary.

Fire

- If tank, rail car or tank truck is involved in a fire, ISOLATE for 800 meters (1/2 mile) in all directions; also, consider initial evacuation for 800 meters (1/2 mile) in all directions.

EMERGENCY RESPONSE**FIRE****Small Fire**

- Dry chemical, CO₂, water spray or regular foam.

Large Fire

- Water spray, fog or regular foam.
- Do not scatter spilled material with high-pressure water streams.
- If it can be done safely, move undamaged containers away from the area around the fire.
- Dike runoff from fire control for later disposal.

Fire Involving Tanks

- Cool containers with flooding quantities of water until well after fire is out.
- Withdraw immediately in case of rising sound from venting safety devices or discoloration of tank.
- ALWAYS stay away from tanks engulfed in fire.

SPILL OR LEAK

- Do not touch or walk through spilled material.
- Stop leak if you can do it without risk.
- Prevent dust cloud.
- For Asbestos, avoid inhalation of dust. Cover spill with plastic sheet or tarp to minimize spreading. Do not clean up or dispose of, except under supervision of a specialist.

Small Dry Spill

- With clean shovel, place material into clean, dry container and cover loosely; move containers from spill area.

Small Spill

- Pick up with sand or other non-combustible absorbent material and place into containers for later disposal.

Large Spill

- Dike far ahead of liquid spill for later disposal.
- Cover powder spill with plastic sheet or tarp to minimize spreading.
- Prevent entry into waterways, sewers, basements or confined areas.

FIRST AID

- Call 911 or emergency medical service.
- Ensure that medical personnel are aware of the material(s) involved and take precautions to protect themselves.
- Move victim to fresh air if it can be done safely.
- Give artificial respiration if victim is not breathing.
- Administer oxygen if breathing is difficult.
- Remove and isolate contaminated clothing and shoes.
- In case of contact with substance, immediately flush skin or eyes with running water for at least 20 minutes.

POTENTIAL HAZARDS

HEALTH

- Inhalation of vapors or contact with substance will result in contamination and potential harmful effects.
- Fire will produce irritating, corrosive and/or toxic gases.

FIRE OR EXPLOSION

- Non-combustible, substance itself does not burn but may react upon heating to produce corrosive and/or toxic fumes.
- Runoff may pollute waterways.

PUBLIC SAFETY

- **CALL 911. Then call emergency response telephone number on shipping paper.** If shipping paper not available or no answer, refer to appropriate telephone number listed on the inside back cover.
- Stay upwind, uphill and/or upstream.
- Keep unauthorized personnel away.

PROTECTIVE CLOTHING

- Wear positive pressure self-contained breathing apparatus (SCBA).
- Structural firefighters' protective clothing provides thermal protection **but only limited chemical protection.**

EVACUATION

Immediate precautionary measure

- Isolate spill or leak area for at least 50 meters (150 feet) in all directions.

Large Spill

- Consider initial downwind evacuation for at least 100 meters (330 feet).

Fire

- When any large container is involved in a fire, consider initial evacuation for 500 meters (1/3 mile) in all directions.

EMERGENCY RESPONSE**FIRE**

- Use extinguishing agent suitable for type of surrounding fire.
- **Do not direct water at the heated metal.**

SPILL OR LEAK

- Do not touch or walk through spilled material.
- Do not touch damaged containers or spilled material unless wearing appropriate protective clothing.
- Stop leak if you can do it without risk.
- Prevent entry into waterways, sewers, basements or confined areas.
- Do not use steel or aluminum tools or equipment.
- Cover with earth, sand or other non-combustible material followed with plastic sheet to minimize spreading or contact with rain.
- For mercury, use a mercury spill kit.
- Mercury spill areas may be subsequently treated with calcium sulphide/calcium sulfide or with sodium thiosulphate/sodium thiosulfate wash to neutralize any residual mercury.

FIRST AID

- Call 911 or emergency medical service.
- Ensure that medical personnel are aware of the material(s) involved and take precautions to protect themselves.
- Move victim to fresh air if it can be done safely.
- Give artificial respiration if victim is not breathing.
- Administer oxygen if breathing is difficult.
- Remove and isolate contaminated clothing and shoes.
- In case of contact with substance, immediately flush skin or eyes with running water for at least 20 minutes.
- Keep victim calm and warm.

POTENTIAL HAZARDS

HEALTH

- **TOXIC; may be fatal if inhaled or absorbed through skin.**
- Vapors may be irritating.
- Contact with gas may cause burns and injury.
- Fire will produce irritating, corrosive and/or toxic gases.
- Runoff from fire control or dilution water may cause environmental contamination.

FIRE OR EXPLOSION

- Some gases may burn or be ignited by heat, sparks or flames.
- May form explosive mixtures with air.
- Oxidizers may ignite combustibles (wood, paper, oil, clothing, etc.) but NOT readily due to low transportation pressures.
- Vapors may travel to source of ignition and flash back.
- Some of these materials may react violently with water.
- Cylinders exposed to fire may vent and release toxic and flammable gas through pressure relief devices.
- Runoff may create fire hazard.

PUBLIC SAFETY

- **CALL 911. Then call emergency response telephone number on shipping paper.** If shipping paper not available or no answer, refer to appropriate telephone number listed on the inside back cover.
- Keep unauthorized personnel away.
- Stay upwind, uphill and/or upstream.
- Many gases are heavier than air and will spread along the ground and collect in low or confined areas (sewers, basements, tanks, etc.).
- Ventilate closed spaces before entering, but only if properly trained and equipped.

PROTECTIVE CLOTHING

- Wear positive pressure self-contained breathing apparatus (SCBA).
- Wear chemical protective clothing that is specifically recommended by the manufacturer **when there is NO RISK OF FIRE.**
- Structural firefighters' protective clothing provides thermal protection **but only limited chemical protection.**

EVACUATION

Immediate precautionary measure

- Isolate spill or leak area for at least 100 meters (330 feet) in all directions.

Spill

- See [Table 1 - Initial Isolation and Protective Action Distances](#).

Fire

- If several small packages (inside a railcar or trailer) are involved in a fire, ISOLATE for 1600 meters (1 mile) in all directions; also, consider initial evacuation for 1600 meters (1 mile) in all directions.



In Canada, an Emergency Response Assistance Plan (ERAP) may be required for this product. Please consult the shipping paper and/or the ERAP Program Section (page 390).

*** SOME SUBSTANCES MAY ALSO BE FLAMMABLE, CORROSIVE AND/OR OXIDIZING**

EMERGENCY RESPONSE

FIRE

- **DO NOT EXTINGUISH A LEAKING GAS FIRE UNLESS LEAK CAN BE STOPPED.**

Small Fire

- Dry chemical, CO₂, water spray or alcohol-resistant foam.
- **For UN3515, UN3518, UN3520**, use water only; no dry chemical, CO₂ or Halon®.

Large Fire

- Water spray, fog or alcohol-resistant foam.
- Do not get water inside containers.
- If it can be done safely, move undamaged containers away from the area around the fire.
- Damaged cylinders should be handled only by specialists.

Fire Involving Several Small Packages (inside a railcar or trailer)

- Fight fire from maximum distance or use unmanned master stream devices or monitor nozzles.
- Cool containers with flooding quantities of water until well after fire is out.
- Do not direct water at source of leak or safety devices.
- Withdraw immediately in case of rising sound from venting safety devices or discoloration of tank.
- **ALWAYS** stay away from tanks engulfed in fire.

SPILL OR LEAK

- Some gases may be flammable. **ELIMINATE** all ignition sources (no smoking, flares, sparks or flames) from immediate area.
- For flammable gases, all equipment used when handling the product must be grounded.
- For oxidizing substances, keep combustibles (wood, paper, oil, etc.) away from spilled material.
- Do not touch or walk through spilled material.
- Stop leak if you can do it without risk.
- Do not direct water at spill or source of leak.
- Use water spray to reduce vapors or divert vapor cloud drift. Avoid allowing water runoff to contact spilled material.
- Prevent entry into waterways, sewers, basements or confined areas.
- Isolate area until gas has dispersed.

FIRST AID

- Call 911 or emergency medical service.
- Ensure that medical personnel are aware of the material(s) involved and take precautions to protect themselves.
- Move victim to fresh air if it can be done safely.
- Give artificial respiration if victim is not breathing.
- **Do not perform mouth-to-mouth resuscitation if victim ingested or inhaled the substance; wash face and mouth before giving artificial respiration. Use a pocket mask equipped with a one-way valve or other proper respiratory medical device.**
- Administer oxygen if breathing is difficult.
- Remove and isolate contaminated clothing and shoes.
- In case of contact with substance, immediately flush skin or eyes with running water for at least 20 minutes.
- In case of burns, immediately cool affected skin for as long as possible with cold water. Do not remove clothing if adhering to skin.
- Keep victim calm and warm.
- Keep victim under observation.
- Effects of contact or inhalation may be delayed.

GUIDE ADSORBED GASES - FLAMMABLE OR OXIDIZING 174

POTENTIAL HAZARDS

FIRE OR EXPLOSION

- Some gases will be ignited by heat, sparks or flames.
- Substance does not burn but will support combustion.
- Vapors may travel to source of ignition and flash back.
- Cylinders exposed to fire may vent and release flammable gas through pressure relief devices.
- Containers may explode when exposed to prolonged direct flame impingement.

HEALTH

- Vapors may cause dizziness or asphyxiation without warning.
- Some may be irritating if inhaled at high concentrations.
- Contact with gas may cause burns and injury.
- Fire may produce irritating and/or toxic gases.

PUBLIC SAFETY

- **CALL 911. Then call emergency response telephone number on shipping paper.** If shipping paper not available or no answer, refer to appropriate telephone number listed on the inside back cover.
- Keep unauthorized personnel away.
- Stay upwind, uphill and/or upstream.
- Many gases are heavier than air and will spread along the ground and collect in low or confined areas (sewers, basements, tanks, etc.).
- Ventilate closed spaces before entering, but only if properly trained and equipped.

PROTECTIVE CLOTHING

- Wear positive pressure self-contained breathing apparatus (SCBA).
- Structural firefighters' protective clothing provides thermal protection **but only limited chemical protection.**

EVACUATION

Immediate precautionary measure

- Isolate spill or leak area for at least 100 meters (330 feet) in all directions.

Large Spill

- Consider initial downwind evacuation for at least 800 meters (1/2 mile).

Fire

- If several small packages (inside a railcar or trailer) are involved in a fire, ISOLATE for 1600 meters (1 mile) in all directions; also, consider initial evacuation for 1600 meters (1 mile) in all directions.



In Canada, an Emergency Response Assistance Plan (ERAP) may be required for this product. Please consult the shipping paper and/or the ERAP Program Section (page 390).

EMERGENCY RESPONSE

FIRE

- **DO NOT EXTINGUISH A LEAKING GAS FIRE UNLESS LEAK CAN BE STOPPED.**

- Use extinguishing agent suitable for type of surrounding fire.

Small Fire

- Dry chemical or CO₂.

Large Fire

- Water spray or fog.
- If it can be done safely, move undamaged containers away from the area around the fire.
- Damaged cylinders should be handled only by specialists.

Fire Involving Several Small Packages (inside a railcar or trailer)

- Fight fire from maximum distance or use unmanned master stream devices or monitor nozzles.
- Cool containers with flooding quantities of water until well after fire is out.
- Do not direct water at source of leak or safety devices.
- Withdraw immediately in case of rising sound from venting safety devices or discoloration of tank.
- ALWAYS stay away from tanks engulfed in fire.
- For massive fire, use unmanned master stream devices or monitor nozzles; if this is impossible, withdraw from area and let fire burn.

SPILL OR LEAK

- For flammable gases, ELIMINATE all ignition sources (no smoking, flares, sparks or flames) from immediate area.
- For oxidizing substances, keep combustibles (wood, paper, oil, etc.) away from spilled material.
- All equipment used when handling the product must be grounded.
- Do not touch or walk through spilled material.
- Stop leak if you can do it without risk.
- Use water spray to reduce vapors or divert vapor cloud drift. Avoid allowing water runoff to contact spilled material.
- Do not direct water at spill or source of leak.
- Prevent spreading of vapors through sewers, ventilation systems and confined areas.
- Ventilate the area.
- Isolate area until gas has dispersed.

FIRST AID

- Call 911 or emergency medical service.
- Ensure that medical personnel are aware of the material(s) involved and take precautions to protect themselves.
- Move victim to fresh air if it can be done safely.
- Give artificial respiration if victim is not breathing.
- Administer oxygen if breathing is difficult.
- Remove and isolate contaminated clothing and shoes.
- In case of burns, immediately cool affected skin for as long as possible with cold water. Do not remove clothing if adhering to skin.
- Keep victim calm and warm.

INTRODUCTION TO GREEN TABLES

TABLE 1 - INITIAL ISOLATION AND PROTECTIVE ACTION DISTANCES

This table suggests distances useful to protect people from vapors/gases resulting from spills involving:

- materials that are considered toxic by inhalation (TIH) (PIH in the US)
- materials that produce toxic gases upon contact with water
- chemical warfare agents

This table provides first responders with initial guidance until technically qualified emergency response personnel are available. For each material, first responders will find distances for the following zones:

- The **Initial Isolation Zone** defines an area **surrounding** the incident in which people may be exposed to dangerous (upwind) and life-threatening (downwind) concentrations of material.
- The **Protective Action Zone** defines an area **downwind** from the incident in which people may become incapacitated and unable to take protective action and/or incur serious or irreversible health effects. Table 1 provides specific guidance for small and large spills occurring day or night.

Adjusting distances for a specific incident involves many interdependent variables. These adjustments should only be made by technically qualified personnel. For this reason, no precise guidance can be provided in this document to aid in adjusting the table distances; however, general guidance follows.

Factors that May Change the Protective Action Distances

Fire

In the **orange-bordered pages**, under **EVACUATION – Fire**, the evacuation distance required to protect against fragmentation hazard of a large container is clearly indicated. If involved in a fire, the toxic hazard may be less dangerous than the fire or explosion hazard.

In these cases, the **fire hazard distance should be used** as an isolation distance and Table 1 should be used to protect downwind for residual material release.

Worst-case scenario: terrorism, sabotage or catastrophic accident

Initial isolation and protective action distances are derived from historical data on transportation incidents and the use of statistical models. For worst-case scenarios involving the instantaneous release of the entire contents of a package (e.g., as a result of terrorism, sabotage or catastrophic accident), the distances may increase substantially.

For such events, **doubling** the initial isolation and protective action distances is appropriate in absence of other information.

When more than one large package is leaking

If more than one rail car, tank truck, tank or large cylinder, containing TIH materials is leaking, **large spill** distances may need to be increased.

Other factors that can increase the protective action distance:

- If a material has a **protective action distance of 11.0+ km (7.0+ miles)**, the actual distance can be larger in certain atmospheric conditions.
- If the material's vapor plume is **channeled in a valley** or **between many tall buildings**, protective action distances may be larger than shown due to less mixing of the plume with the atmosphere.
- If there is a **daytime spill** in a region with known **strong temperature inversions** or **snow cover**, or it occurs **near sunset**, this may require an increase of the protective action distance because airborne contaminants mix and disperse more slowly and may travel much farther downwind.
 - › In such cases, the nighttime protective action distances may be more appropriate.
- If the temperature of the **liquid spill** or the **outdoor temperature exceeds 30°C (86°F)**, the protective action distance may be larger.

Water-reactive materials

Materials that react with water to produce large amounts of toxic gases are included in Table 1. Some of these materials have 2 entries in Table 1. They are identified by **(when spilled on land)** since they are TIH products and **(when spilled in water)** because they produce additional toxic gases when spilled in water.

Choose the **larger protective action distance** if:

- it is not clear whether the spill is on land or in water
- the spill occurs both on land and in water

TABLE 2 - WATER-REACTIVE MATERIALS WHICH PRODUCE TOXIC GASES

This table lists materials that produce large amounts of Toxic Inhalation Hazard gases (TIH) when spilled in water as well as the TIH gases that are produced.

NOTE: The produced TIH gases indicated in Table 2 are for information purposes only. In Table 1, the initial isolation and protective action distances have already taken into consideration the produced TIH gas.

When a water-reactive TIH-producing material is spilled into a river or stream, the source of the toxic gas may flow downstream for a great distance.

TABLE 3 - INITIAL ISOLATION AND PROTECTIVE ACTION DISTANCES FOR LARGE SPILLS FOR DIFFERENT QUANTITIES OF SIX COMMON TIH (PIH IN THE US) GASES

This table lists materials that may be more commonly encountered. These materials are:

- UN1005 - Ammonia, anhydrous
- UN1017 - Chlorine
- UN1040 - Ethylene oxide and UN1040 - Ethylene oxide with nitrogen

- UN1050 - Hydrogen chloride, anhydrous and UN2186 - Hydrogen chloride, refrigerated liquid
- UN1052 - Hydrogen fluoride, anhydrous
- UN1079 - Sulfur dioxide/Sulphur dioxide

This table provides initial isolation and protective action distances for large spills (more than 208 liters or 55 US gallons):

- involving different container types (therefore different volume capacities)
- for daytime and nighttime situations
- for different wind speeds (low, moderate and high)

PROTECTIVE ACTIONS

Protective actions are the steps taken to preserve the health and safety of emergency responders and the public during an incident involving releases of hazardous materials/dangerous goods.

Table 1 - Initial Isolation and Protective Action Distances (green-bordered pages) predicts the size of the area that could be affected by a cloud of toxic gas. People in this area should be evacuated and/or sheltered-in-place inside buildings.

Isolate hazard area and deny entry means to keep everybody away from the area if they are not directly involved in emergency response operations. Unprotected emergency responders should not be allowed to enter the isolation zone.

This "isolation" task is done to establish control over the area of operations. This is the first step for any protective actions that may follow.

Evacuate means to move all people from a threatened area to a safer place. To perform an evacuation, there must be enough time for people to be warned, get ready, and leave an area. If there is enough time, evacuation is the best protective action.

Begin evacuating people nearby and those who are outdoors in direct view of the scene. When additional help arrives, expand the area to be evacuated downwind and crosswind to at least the extent recommended in this guidebook.

Even after people move to the distances recommended, they may not be completely safe from harm. They should not be permitted to gather at such distances. Send evacuees to a definite place, by a specific route, far enough away so they will not have to be moved again if the wind shifts.

Shelter-in-place means people should seek shelter inside a building and remain inside until the danger passes. **It is vital for first responders to maintain communications with sheltered-in-place people** so that they are advised about changing conditions.

Sheltering-in-place is used either when:

- evacuating the public would cause greater risk than staying where they are
- an evacuation cannot be performed

Direct the people inside to:

- close all doors and windows
- shut off all ventilating, heating and cooling systems
- stay far from windows to avoid shattered glass and projectile metal fragments in the event of a fire and/or explosion
- tune in to local radio or TV stations, and stay inside until told it is safe to leave by first responders

Shelter-in-place may not be the best option if:

- the vapors are flammable

- it will take a long time for the gas to clear the area
- buildings cannot be closed tightly

Vehicles can offer some protection for a short period if the windows are closed and the ventilation systems are shut off. Vehicles are not as effective as buildings for in-place protection.

NOTE: Every hazardous materials/dangerous goods incident is different. Each will have special problems and concerns. Actions to protect the public must be carefully selected. These pages can help with **initial** decisions on how to protect the public. Officials must continue to gather information and monitor the situation until the threat is removed.

PROTECTIVE ACTION DECISION FACTORS TO CONSIDER

The choice of protective actions for a given situation depends on a number of factors. For some cases, evacuation may be the best option; in others, sheltering-in-place may be the best course. Sometimes, these two actions may be used in combination. In any emergency, officials need to quickly give the public instructions. The public will need continuing information and instructions while being evacuated or sheltered-in-place.

Proper evaluation of the factors listed below will determine the effectiveness of evacuation or in-place protection (shelter-in-place). The importance of these factors can vary with emergency conditions. In specific emergencies, other factors may need to be identified and considered as well. This list indicates what kind of information may be needed to make the initial decision.

The hazardous materials/dangerous goods:

- degree of health hazard
- chemical and physical properties
- amount involved
- containment/control of release
- rate of vapor movement

The population threatened:

- location
- number of people
- time available to evacuate or shelter-in-place
- ability to control evacuation or shelter-in-place
- building types and availability
- special institutions or populations, e.g., nursing homes, hospitals, prisons

The weather conditions:

- effect on vapor and cloud movement
- potential for change
- effect on evacuation or shelter-in-place

BACKGROUND ON TABLE 1 – INITIAL ISOLATION AND PROTECTIVE ACTION DISTANCES

Initial isolation and protective action distances in this guidebook were determined for small and large spills occurring during day or night. The overall analysis, statistical in nature, was conducted using:

- state-of-the-art emission rate and dispersion models
- statistical release data from the U.S. Department of Transportation (DOT) Hazardous Materials Information System (HMIS) database
- meteorological observations from more than 120 locations in the United States, Canada, and Mexico
- the most current toxicological exposure guidelines

For each chemical, thousands of hypothetical releases were modeled to account for the statistical variance in both release amount and atmospheric conditions. Based on this statistical sample, they selected the 90th percentile protective action distance for each chemical and category to appear in the table. A brief description of the analysis is provided below.

A detailed report outlining the methodology and data used to generate the initial isolation and protective action distances may be obtained from the U.S. DOT, Pipeline and Hazardous Materials Safety Administration (PHMSA).

DESCRIPTION OF THE ANALYSIS

Release amounts and emission rates into the atmosphere were statistically modeled based on:

- data from the U.S. DOT HMIS database
- container types and sizes authorized for transport as specified in 49 CFR §172.101 and Part 173
- physical properties of the individual materials
- atmospheric data from a historical database

For liquefied gases, which can flash to form both a vapor/aerosol mixture and an evaporating pool, the emission model calculated one or both of:

- the release of vapor due to evaporation of pools on the ground
- direct release of vapors from the container

The emission model also calculated the emission of toxic vapor by-products generated from spilling water-reactive materials in water.

Small spills involve 208 liters (55 US gallons) or less.

Large spills involve greater quantities.

The exceptions are the entries at the beginning of Table 1 marked **(when used as a weapon)**. The volumes used for these calculations varies, but in most cases:

- Small spills include releases up to 2 kg (4.4 lbs.).
- Large spills include releases up to 25 kg (55 lbs.).

Downwind dispersion of the vapor was estimated for each case modeled. Using a database containing hourly meteorological data from 120 American, Canadian, and Mexican cities, the atmospheric parameters affecting the dispersion and the emission rate were selected.

The dispersion calculation accounted for both the:

- time-dependent emission rate from the source
- density of the vapor plume (i.e., heavy gas effects)

Since atmospheric mixing is less effective at dispersing vapor plumes during nighttime, day and night were separated in the analysis.

In the table:

- **day** refers to time periods after sunrise and before sunset
- **night** includes all hours between sunset and sunrise

Toxicological short-term exposure guidelines for the materials were applied to determine the downwind distance to which people may:

- become incapacitated and unable to take protective action
- incur serious health effects after a single, or rare, exposure

When available, toxicological exposure guidelines were chosen from AEGL-2 or ERPG-2 emergency response guidelines. AEGL-2 values were the first choice.

For materials without AEGL-2 or ERPG-2 values, emergency response guidelines were estimated based on lethal concentration limits derived from animal-based-studies. This approach was recommended by an independent panel of toxicological experts from industry and academia.

HOW TO USE TABLE 1 – INITIAL ISOLATION AND PROTECTIVE ACTION DISTANCES

- (1) The responder should already have:
 - identified the material by its ID number and name (if you cannot find an ID number, use the Name of Material index in the blue-bordered pages to find that number);
 - confirmed that the material is highlighted in green in the yellow or blue-bordered pages. If not, Table 1 doesn't apply;
 - found the three-digit guide for the material, in order to consult emergency actions it recommends along with this table; and
 - **noted the wind direction**
- (2) Look in Table 1 (green-bordered pages) for the ID number and name of the material involved. Some ID numbers have more than one shipping name listed. Look for the specific name of the material. If you do not know the shipping name and Table 1 lists more than one name for the same ID number, use the entry with the largest distances.
- (3) Determine if the incident involves a SMALL or LARGE spill and if it is DAY or NIGHT. A SMALL SPILL consists of a release of 208 liters (55 US gallons) or less. This generally corresponds to a spill from a single small package (for example, a drum), a small cylinder, or a small leak from a large package. A LARGE SPILL consists of a release of more than 208 liters (55 US gallons). This usually involves a spill from a large package, or multiple spills from many small packages. DAY is any time after sunrise and before sunset. NIGHT is any time between sunset and sunrise.

- (4) Look up the INITIAL ISOLATION DISTANCE. This distance defines the radius of a zone (initial isolation zone) surrounding the spill in ALL DIRECTIONS. In this zone, protective clothing and respiratory protection is required. Evacuate the general public in a direction perpendicular to wind direction (crosswind) and away from the spill.

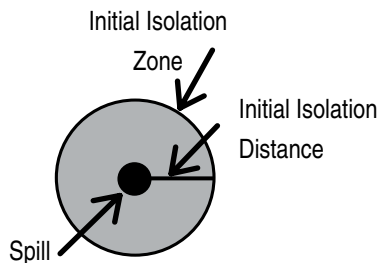

- (5) Look up the PROTECTIVE ACTION DISTANCE. For a given material, spill size, and whether day or night, Table 1 gives the downwind distance—in kilometers and miles—from the spill or leak source, for which you should consider protective actions. For practical purposes, the protective action zone (i.e., the area in which people are at risk of harmful exposure) is a square. Its length and width are the same as the downwind distance shown in Table 1. Protective actions are the

TABLE 1 - INITIAL ISOLATION AND PROTECTIVE ACTION DISTANCES

ID No.	Guide NAME OF MATERIAL	SMALL SPILLS (From a small package or small leak from a large package)				LARGE SPILLS (From a large package or from many small packages)			
		First ISOLATE in all Directions		Then PROTECT persons Downwind during		First ISOLATE in all Directions		Then PROTECT persons Downwind during	
		Meters (Feet)	Kilometers (Miles)	DAY Kilometers (Miles)	NIGHT Kilometers (Miles)	Meters (Feet)	Kilometers (Miles)	DAY Kilometers (Miles)	NIGHT Kilometers (Miles)
---	117 AC (when used as a weapon)	60 m (200 ft)	0.3 km (0.2 mi)	1.0 km (0.6 mi)	1000 m (3000 ft)	3.7 km (2.3 mi)	8.4 km (5.3 mi)		
---	154 Adamsite (when used as a weapon)	30 m (100 ft)	0.1 km (0.1 mi)	0.3 km (0.2 mi)	60 m (200 ft)	0.3 km (0.2 mi)	1.4 km (0.9 mi)		
---	153 Buzz (when used as a weapon)	60 m (200 ft)	0.4 km (0.2 mi)	1.7 km (1.1 mi)	400 m (1250 ft)	2.2 km (1.4 mi)	8.1 km (5.0 mi)		
---	153 BZ (when used as a weapon)	60 m (200 ft)	0.4 km (0.2 mi)	1.7 km (1.1 mi)	400 m (1250 ft)	2.2 km (1.4 mi)	8.1 km (5.0 mi)		
---	159 CA (when used as a weapon)	30 m (100 ft)	0.1 km (0.1 mi)	0.4 km (0.3 mi)	100 m (300 ft)	0.5 km (0.4 mi)	2.6 km (1.6 mi)		
---	125 CG (when used as a weapon)	150 m (500 ft)	0.8 km (0.5 mi)	3.2 km (2.0 mi)	1000 m (3000 ft)	7.5 km (4.7 mi)	11.0+ km (7.0+ mi)		
---	125 CK (when used as a weapon)	30 m (100 ft)	0.2 km (0.2 mi)	1.4 km (0.9 mi)	300 m (1000 ft)	1.4 km (0.9 mi)	6.1 km (3.8 mi)		
---	153 CN (when used as a weapon)	30 m (100 ft)	0.1 km (0.1 mi)	0.2 km (0.1 mi)	60 m (200 ft)	0.3 km (0.2 mi)	1.2 km (0.8 mi)		
---	153 CS (when used as a weapon)	30 m (100 ft)	0.1 km (0.1 mi)	0.6 km (0.4 mi)	100 m (300 ft)	0.4 km (0.3 mi)	1.9 km (1.2 mi)		
---	154 CX (when used as a weapon)	60 m (200 ft)	0.2 km (0.2 mi)	1.1 km (0.7 mi)	200 m (600 ft)	1.2 km (0.7 mi)	5.1 km (3.2 mi)		
---	151 DA (when used as a weapon)	30 m (100 ft)	0.2 km (0.1 mi)	0.8 km (0.5 mi)	300 m (1000 ft)	1.9 km (1.2 mi)	7.5 km (4.7 mi)		
---	153 DC (when used as a weapon)	30 m (100 ft)	0.1 km (0.1 mi)	0.6 km (0.4 mi)	60 m (200 ft)	0.4 km (0.3 mi)	1.8 km (1.1 mi)		
---	154 DM (when used as a weapon)	30 m (100 ft)	0.1 km (0.1 mi)	0.3 km (0.2 mi)	60 m (200 ft)	0.3 km (0.2 mi)	1.4 km (0.9 mi)		
---	125 DP (when used as a weapon)	30 m (100 ft)	0.2 km (0.1 mi)	0.7 km (0.4 mi)	200 m (600 ft)	1.0 km (0.7 mi)	2.4 km (1.5 mi)		
---	151 ED (when used as a weapon)	150 m (500 ft)	0.9 km (0.6 mi)	2.1 km (1.3 mi)	1000 m (3000 ft)	5.9 km (3.7 mi)	8.3 km (5.2 mi)		
---	153 GA (when used as a weapon)	30 m (100 ft)	0.2 km (0.1 mi)	0.2 km (0.1 mi)	100 m (300 ft)	0.5 km (0.4 mi)	0.6 km (0.4 mi)		

---	153	GB (when used as a weapon)	60 m (200 ft)	0.4 km (0.3 mi)	1.1 km (0.7 mi)	400 m (1250 ft)	2.1 km (1.3 mi)	4.9 km (3.0 mi)
---	153	GD (when used as a weapon)	60 m (200 ft)	0.4 km (0.3 mi)	0.7 km (0.5 mi)	300 m (1000 ft)	1.8 km (1.1 mi)	2.7 km (1.7 mi)
---	153	GF (when used as a weapon)	30 m (100 ft)	0.2 km (0.2 mi)	0.3 km (0.2 mi)	150 m (500 ft)	0.8 km (0.5 mi)	1.0 km (0.6 mi)
---	153	H (when used as a weapon)	30 m (100 ft)	0.1 km (0.1 mi)	0.1 km (0.1 mi)	60 m (200 ft)	0.3 km (0.2 mi)	0.4 km (0.3 mi)
---	153	HD (when used as a weapon)	30 m (100 ft)	0.1 km (0.1 mi)	0.1 km (0.1 mi)	60 m (200 ft)	0.3 km (0.2 mi)	0.4 km (0.3 mi)
---	153	HL (when used as a weapon)	30 m (100 ft)	0.1 km (0.1 mi)	0.3 km (0.2 mi)	100 m (300 ft)	0.5 km (0.3 mi)	1.0 km (0.6 mi)
---	153	HN-1 (when used as a weapon)	60 m (200 ft)	0.3 km (0.2 mi)	0.5 km (0.3 mi)	200 m (600 ft)	1.1 km (0.7 mi)	1.8 km (1.1 mi)
---	153	HN-2 (when used as a weapon)	60 m (200 ft)	0.3 km (0.2 mi)	0.6 km (0.4 mi)	300 m (1000 ft)	1.3 km (0.8 mi)	2.1 km (1.3 mi)
---	153	HN-3 (when used as a weapon)	30 m (100 ft)	0.1 km (0.1 mi)	0.1 km (0.1 mi)	60 m (200 ft)	0.3 km (0.2 mi)	0.3 km (0.2 mi)
---	153	L (Lewisite) (when used as a weapon)	30 m (100 ft)	0.1 km (0.1 mi)	0.3 km (0.2 mi)	100 m (300 ft)	0.5 km (0.3 mi)	1.0 km (0.6 mi)
---	153	Lewisite (when used as a weapon)	30 m (100 ft)	0.1 km (0.1 mi)	0.3 km (0.2 mi)	100 m (300 ft)	0.5 km (0.3 mi)	1.0 km (0.6 mi)
---	152	MD (when used as a weapon)	300 m (1000 ft)	1.6 km (1.0 mi)	4.3 km (2.7 mi)	1000 m (3000 ft)	11.0+ km (7.0+ mi)	11.0+ km (7.0+ mi)
---	153	Mustard (when used as a weapon)	30 m (100 ft)	0.1 km (0.1 mi)	0.1 km (0.1 mi)	60 m (200 ft)	0.3 km (0.2 mi)	0.4 km (0.3 mi)
---	153	Mustard Lewisite (when used as a weapon)	30 m (100 ft)	0.1 km (0.1 mi)	0.3 km (0.2 mi)	100 m (300 ft)	0.5 km (0.3 mi)	1.0 km (0.6 mi)
---	152	PD (when used as a weapon)	60 m (200 ft)	0.4 km (0.3 mi)	0.4 km (0.3 mi)	300 m (1000 ft)	1.6 km (1.0 mi)	1.6 km (1.0 mi)
---	119	SA (when used as a weapon)	300 m (1000 ft)	1.9 km (1.2 mi)	5.7 km (3.6 mi)	1000 m (3000 ft)	8.9 km (5.6 mi)	11.0+ km (7.0+ mi)
---	153	Sarin (when used as a weapon)	60 m (200 ft)	0.4 km (0.3 mi)	1.1 km (0.7 mi)	400 m (1250 ft)	2.1 km (1.3 mi)	4.9 km (3.0 mi)

"+" means distance can be larger in certain atmospheric conditions

TABLE 1

TABLE 1 - INITIAL ISOLATION AND PROTECTIVE ACTION DISTANCES

		SMALL SPILLS (From a small package or small leak from a large package)				LARGE SPILLS (From a large package or from many small packages)				
ID No.	Guide	NAME OF MATERIAL	First ISOLATE in all Directions		Then PROTECT persons Downwind during		First ISOLATE in all Directions		Then PROTECT persons Downwind during	
			Meters (Feet)	Kilometers (Miles)	DAY Kilometers (Miles)	NIGHT Kilometers (Miles)	Meters (Feet)	Kilometers (Miles)	DAY Kilometers (Miles)	NIGHT Kilometers (Miles)
---	153	Soman (when used as a weapon)	60 m (200 ft)	0.4 km (0.3 mi)	0.7 km (0.5 mi)	300 m (1000 ft)	1.8 km (1.1 mi)	2.7 km (1.7 mi)		
---	153	Tabun (when used as a weapon)	30 m (100 ft)	0.2 km (0.1 mi)	0.2 km (0.1 mi)	100 m (300 ft)	0.5 km (0.4 mi)	0.6 km (0.4 mi)		
---	153	Thickened GD (when used as a weapon)	60 m (200 ft)	0.4 km (0.3 mi)	0.7 km (0.5 mi)	300 m (1000 ft)	1.8 km (1.1 mi)	2.7 km (1.7 mi)		
---	153	VX (when used as a weapon)	30 m (100 ft)	0.1 km (0.1 mi)	0.1 km (0.1 mi)	60 m (200 ft)	0.4 km (0.2 mi)	0.3 km (0.2 mi)		
1005	125	Ammonia, anhydrous	30 m (100 ft)	0.1 km (0.1 mi)	0.2 km (0.1 mi)		Refer to table 3			
1005	125	Anhydrous ammonia	30 m (100 ft)	0.1 km (0.1 mi)	0.2 km (0.1 mi)					
1008	125	Boron trifluoride	30 m (100 ft)	0.2 km (0.1 mi)	0.7 km (0.5 mi)	400 m (1250 ft)	2.3 km (1.4 mi)	5.1 km (3.2 mi)		
1008	125	Boron trifluoride, compressed	30 m (100 ft)	0.1 km (0.1 mi)	0.2 km (0.1 mi)	200 m (600 ft)	1.2 km (0.7 mi)	4.3 km (2.7 mi)		
1016	119	Carbon monoxide	30 m (100 ft)	0.1 km (0.1 mi)	0.2 km (0.1 mi)		Refer to table 3			
1016	119	Carbon monoxide, compressed	30 m (100 ft)	0.1 km (0.1 mi)	0.2 km (0.1 mi)					
1017	124	Chlorine	60 m (200 ft)	0.3 km (0.2 mi)	1.4 km (0.9 mi)	60 m (200 ft)	0.3 km (0.2 mi)	1.1 km (0.7 mi)		
1026	119	Cyanogen	30 m (100 ft)	0.1 km (0.1 mi)	0.4 km (0.3 mi)		Refer to table 3			
1040	119P	Ethylene oxide	30 m (100 ft)	0.1 km (0.1 mi)	0.2 km (0.2 mi)					
1040	119P	Ethylene oxide with Nitrogen	30 m (100 ft)	0.1 km (0.1 mi)	0.2 km (0.1 mi)	100 m (300 ft)	0.5 km (0.3 mi)	2.3 km (1.4 mi)		
1045	124	Fluorine	30 m (100 ft)	0.1 km (0.1 mi)	0.2 km (0.1 mi)	150 m (500 ft)	1.0 km (0.6 mi)	3.4 km (2.1 mi)		
1045	124	Fluorine, compressed	30 m (100 ft)	0.1 km (0.1 mi)	0.2 km (0.2 mi)		Refer to table 3			
1048	125	Hydrogen bromide, anhydrous	30 m (100 ft)	0.1 km (0.1 mi)	0.2 km (0.2 mi)					
1050	125	Hydrogen chloride, anhydrous	30 m (100 ft)	0.1 km (0.1 mi)	0.3 km (0.2 mi)		Refer to table 3			

1051	117P	Hydrogen cyanide, anhydrous, stabilized	60 m (200 ft)	0.2 km (0.1 mi)	0.6 km (0.4 mi)	200 m (600 ft)	0.7 km (0.5 mi)	1.7 km (1.1 mi)
1051	117P	Hydrogen cyanide, stabilized	30 m (100 ft)	0.1 km (0.1 mi)	0.5 km (0.3 mi)		Refer to table 3	
1052	125	Hydrogen fluoride, anhydrous	30 m (100 ft)	0.1 km (0.1 mi)	0.5 km (0.3 mi)	400 m (1250 ft)	2.2 km (1.4 mi)	6.3 km (3.9 mi)
1053	117	Hydrogen sulfide	30 m (100 ft)	0.1 km (0.1 mi)	0.5 km (0.3 mi)	200 m (600 ft)	0.7 km (0.4 mi)	2.1 km (1.3 mi)
1053	117	Hydrogen sulphide	30 m (100 ft)	0.1 km (0.1 mi)	0.1 km (0.1 mi)	150 m (500 ft)	0.3 km (0.2 mi)	0.8 km (0.5 mi)
1061	118	Methylamine, anhydrous	30 m (100 ft)	0.1 km (0.1 mi)	0.2 km (0.1 mi)	200 m (600 ft)	1.3 km (0.8 mi)	4.1 km (2.6 mi)
1062	123	Methyl bromide	30 m (100 ft)	0.1 km (0.1 mi)	0.1 km (0.1 mi)	200 m (600 ft)	1.4 km (0.9 mi)	3.3 km (2.1 mi)
1064	117	Methyl mercaptan	30 m (100 ft)	0.1 km (0.1 mi)	0.3 km (0.2 mi)	400 m (1250 ft)	4.3 km (2.7 mi)	10.8 km (6.7 mi)
1067	124	Dinitrogen tetroxide	30 m (100 ft)	0.1 km (0.1 mi)	0.4 km (0.3 mi)	800 m (2500 ft)	2.9 km (1.8 mi)	9.2 km (5.7 mi)
1067	124	Nitrogen dioxide	30 m (100 ft)	0.1 km (0.1 mi)	0.4 km (0.3 mi)	500 m (1500 ft)		
1069	125	Nitrosyl chloride	30 m (100 ft)	0.2 km (0.2 mi)	1.0 km (0.6 mi)		Refer to table 3	
1076	125	Phosgene	100 m (300 ft)	0.6 km (0.4 mi)	2.4 km (1.5 mi)			
1079	125	Sulfur dioxide	100 m (300 ft)	0.6 km (0.4 mi)	2.5 km (1.6 mi)			
1079	125	Sulphur dioxide	100 m (300 ft)	0.6 km (0.4 mi)	2.5 km (1.6 mi)			
1082	119P	Refrigerant gas R-1113	30 m (100 ft)	0.1 km (0.1 mi)	0.1 km (0.1 mi)	60 m (200 ft)	0.4 km (0.2 mi)	0.8 km (0.5 mi)
1082	119P	Trifluorochloroethylene, stabilized	100 m (300 ft)	1.2 km (0.8 mi)	3.3 km (2.1 mi)	500 m (1500 ft)	6.1 km (3.8 mi)	10.8 km (6.7 mi)
1092	131P	Acrolein, stabilized	30 m (100 ft)	0.2 km (0.2 mi)	0.6 km (0.4 mi)	100 m (300 ft)	1.2 km (0.8 mi)	2.3 km (1.4 mi)
1093	131P	Acrylonitrile, stabilized	30 m (100 ft)	0.2 km (0.1 mi)	0.3 km (0.2 mi)	60 m (200 ft)	0.7 km (0.5 mi)	1.2 km (0.8 mi)
1098	131	Allyl alcohol	30 m (100 ft)	0.1 km (0.1 mi)	0.1 km (0.1 mi)	30 m (100 ft)	0.1 km (0.1 mi)	0.1 km (0.1 mi)
1135	131	Ethylene chlorohydrin	30 m (100 ft)	0.1 km (0.1 mi)	0.2 km (0.1 mi)	60 m (200 ft)	0.5 km (0.3 mi)	0.7 km (0.5 mi)
1143	131P	Crotonaldehyde	30 m (100 ft)	0.1 km (0.1 mi)	0.2 km (0.1 mi)			
1143	131P	Crotonaldehyde, stabilized	30 m (100 ft)	0.1 km (0.1 mi)	0.2 km (0.1 mi)			

"+" means distance can be larger in certain atmospheric conditions

TABLE 1

TABLE 1 - INITIAL ISOLATION AND PROTECTIVE ACTION DISTANCES

		SMALL SPILLS (From a small package or small leak from a large package)				LARGE SPILLS (From a large package or from many small packages)				
ID No.	Guide	NAME OF MATERIAL	First ISOLATE in all Directions		Then PROTECT persons Downwind during		First ISOLATE in all Directions		Then PROTECT persons Downwind during	
			Meters (Feet)	Kilometers (Miles)	DAY Kilometers (Miles)	NIGHT Kilometers (Miles)	Meters (Feet)	Kilometers (Miles)	DAY Kilometers (Miles)	NIGHT Kilometers (Miles)
1162	155	Dimethyldichlorosilane (when spilled in water)	30 m (100 ft)	0.1 km (0.1 mi)	0.2 km (0.2 mi)	0.2 km (0.2 mi)	60 m (200 ft)	0.6 km (0.4 mi)	1.8 km (1.1 mi)	
1163	131	Dimethylhydrazine, unsymmetrical	30 m (100 ft)	0.2 km (0.1 mi)	0.5 km (0.3 mi)	0.5 km (0.3 mi)	100 m (300 ft)	1.0 km (0.6 mi)	1.8 km (1.1 mi)	
1182	155	Ethyl chloroformate	30 m (100 ft)	0.2 km (0.1 mi)	0.3 km (0.2 mi)	0.3 km (0.2 mi)	60 m (200 ft)	0.6 km (0.4 mi)	0.9 km (0.6 mi)	
1183	139	Ethyldichlorosilane (when spilled in water)	30 m (100 ft)	0.1 km (0.1 mi)	0.1 km (0.1 mi)	0.1 km (0.1 mi)	60 m (200 ft)	0.6 km (0.4 mi)	2.0 km (1.3 mi)	
1185	131P	Ethyleneimine, stabilized	30 m (100 ft)	0.2 km (0.1 mi)	0.5 km (0.3 mi)	0.5 km (0.3 mi)	200 m (600 ft)	0.9 km (0.6 mi)	1.8 km (1.1 mi)	
1196	155	Ethyltrichlorosilane (when spilled in water)	30 m (100 ft)	0.1 km (0.1 mi)	0.5 km (0.3 mi)	0.5 km (0.3 mi)	200 m (600 ft)	2.1 km (1.3 mi)	5.8 km (3.6 mi)	
1238	155	Methyl chloroformate	30 m (100 ft)	0.2 km (0.2 mi)	0.5 km (0.4 mi)	0.5 km (0.4 mi)	150 m (500 ft)	1.1 km (0.7 mi)	2.1 km (1.3 mi)	
1239	131	Methyl chloromethyl ether	60 m (200 ft)	0.5 km (0.3 mi)	1.5 km (0.9 mi)	1.5 km (0.9 mi)	300 m (1000 ft)	3.1 km (2.0 mi)	5.8 km (3.6 mi)	
1242	139	Methyldichlorosilane (when spilled in water)	30 m (100 ft)	0.1 km (0.1 mi)	0.1 km (0.1 mi)	0.1 km (0.1 mi)	60 m (200 ft)	0.8 km (0.5 mi)	2.3 km (1.5 mi)	
1244	131	Methylhydrazine	30 m (100 ft)	0.3 km (0.2 mi)	0.6 km (0.4 mi)	0.6 km (0.4 mi)	100 m (300 ft)	1.4 km (0.9 mi)	2.1 km (1.3 mi)	
1250	155	Methyltrichlorosilane (when spilled in water)	30 m (100 ft)	0.1 km (0.1 mi)	0.1 km (0.1 mi)	0.1 km (0.1 mi)	60 m (200 ft)	0.8 km (0.5 mi)	2.5 km (1.6 mi)	
1251	131P	Methyl vinyl ketone, stabilized	100 m (300 ft)	0.3 km (0.2 mi)	0.7 km (0.4 mi)	0.7 km (0.4 mi)	800 m (2500 ft)	1.6 km (1.0 mi)	2.8 km (1.8 mi)	
1259	131	Nickel carbonyl	100 m (300 ft)	1.3 km (0.8 mi)	5.0 km (3.1 mi)	5.0 km (3.1 mi)	1000 m (3000 ft)	10.8 km (6.8 mi)	11.0+ km (7.0+ mi)	

1295	139	Trichlorosilane (when spilled in water)	30 m (100 ft)	0.1 km (0.1 mi)	0.1 km (0.1 mi)	0.1 km (0.1 mi)	60 m (200 ft)	0.6 km (0.4 mi)	2.1 km (1.3 mi)
1298	155	Trimethylchlorosilane (when spilled in water)	30 m (100 ft)	0.1 km (0.1 mi)	0.1 km (0.1 mi)	0.1 km (0.1 mi)	60 m (200 ft)	0.5 km (0.3 mi)	1.4 km (0.9 mi)
1305	155P	Vinyltrichlorosilane (when spilled in water)	30 m (100 ft)	0.1 km (0.1 mi)	0.1 km (0.1 mi)	0.1 km (0.1 mi)	60 m (200 ft)	0.6 km (0.4 mi)	1.9 km (1.2 mi)
1305	155P	Vinyltrichlorosilane, stabilized (when spilled in water)	30 m (100 ft)	0.1 km (0.1 mi)	0.1 km (0.1 mi)	0.1 km (0.1 mi)	60 m (200 ft)	0.6 km (0.4 mi)	1.9 km (1.2 mi)
1340	139	Phosphorus pentasulfide, free from yellow and white Phosphorus							
1340	139	Phosphorus pentasulphide, free from yellow and white Phosphorus (when spilled in water)	30 m (100 ft)	0.1 km (0.1 mi)	0.1 km (0.1 mi)	0.1 km (0.1 mi)	60 m (200 ft)	0.3 km (0.2 mi)	1.4 km (0.9 mi)
1360	139	Calcium phosphide (when spilled in water)	30 m (100 ft)	0.1 km (0.1 mi)	0.4 km (0.3 mi)	0.4 km (0.3 mi)	300 m (1000 ft)	1.0 km (0.6 mi)	3.5 km (2.2 mi)
1380	135	Pentaborane	60 m (200 ft)	0.6 km (0.4 mi)	1.9 km (1.2 mi)	1.9 km (1.2 mi)	200 m (600 ft)	2.7 km (1.7 mi)	6.2 km (3.9 mi)
1384	135	Sodium dithionite (when spilled in water)							
1384	135	Sodium hydrosulfite (when spilled in water)	30 m (100 ft)	0.1 km (0.1 mi)	0.4 km (0.3 mi)	0.4 km (0.3 mi)	60 m (200 ft)	0.6 km (0.4 mi)	2.5 km (1.6 mi)
1384	135	Sodium hydrosulphite (when spilled in water)	30 m (100 ft)	0.1 km (0.1 mi)	0.4 km (0.3 mi)	0.4 km (0.3 mi)	60 m (200 ft)	0.6 km (0.4 mi)	2.5 km (1.6 mi)
1390	139	Alkali metal amides (when spilled in water)	30 m (100 ft)	0.1 km (0.1 mi)	0.3 km (0.2 mi)	0.3 km (0.2 mi)	60 m (200 ft)	0.6 km (0.4 mi)	2.2 km (1.4 mi)
1397	139	Aluminum phosphide (when spilled in water)	30 m (100 ft)	0.1 km (0.1 mi)	0.7 km (0.5 mi)	0.7 km (0.5 mi)	500 m (1500 ft)	2.0 km (1.2 mi)	6.5 km (4.0 mi)

"+" means distance can be larger in certain atmospheric conditions

TABLE 1

TABLE 1 - INITIAL ISOLATION AND PROTECTIVE ACTION DISTANCES

		SMALL SPILLS (From a small package or small leak from a large package)				LARGE SPILLS (From a large package or from many small packages)				
ID No.	Guide	NAME OF MATERIAL	First ISOLATE in all Directions		Then PROTECT persons Downwind during		First ISOLATE in all Directions		Then PROTECT persons Downwind during	
			Meters (Feet)	Kilometers (Miles)	DAY Kilometers (Miles)	NIGHT Kilometers (Miles)	Meters (Feet)	Kilometers (Miles)	DAY Kilometers (Miles)	NIGHT Kilometers (Miles)
1419	139	Magnesium aluminum phosphide (when spilled in water)	30 m (100 ft)	0.1 km (0.1 mi)	0.6 km (0.4 mi)	0.1 km (0.1 mi)	500 m (1500 ft)	1.8 km (1.1 mi)	5.8 km (3.6 mi)	
1432	139	Sodium phosphide (when spilled in water)	30 m (100 ft)	0.1 km (0.1 mi)	0.4 km (0.2 mi)	0.1 km (0.1 mi)	300 m (1000 ft)	1.3 km (0.8 mi)	3.8 km (2.4 mi)	
1510	143	Tetranitromethane	30 m (100 ft)	0.2 km (0.1 mi)	0.3 km (0.2 mi)	0.2 km (0.1 mi)	30 m (100 ft)	0.4 km (0.3 mi)	0.7 km (0.4 mi)	
1541	155	Acetone cyanohydrin, stabilized (when spilled in water)	30 m (100 ft)	0.1 km (0.1 mi)	0.1 km (0.1 mi)	0.1 km (0.1 mi)	60 m (200 ft)	0.2 km (0.2 mi)	0.8 km (0.5 mi)	
1556	152	Methyldichlorarsine	100 m (300 ft)	1.4 km (0.9 mi)	2.1 km (1.3 mi)	1.4 km (0.9 mi)	300 m (1000 ft)	3.8 km (2.4 mi)	5.2 km (3.3 mi)	
1560	157	Arsenic chloride	30 m (100 ft)	0.2 km (0.1 mi)	0.3 km (0.2 mi)	0.2 km (0.1 mi)	100 m (300 ft)	1.0 km (0.6 mi)	1.5 km (1.0 mi)	
1560	157	Arsenic trichloride	30 m (100 ft)	0.4 km (0.3 mi)	1.2 km (0.7 mi)	0.4 km (0.3 mi)	150 m (500 ft)	1.6 km (1.0 mi)	3.2 km (2.0 mi)	
1569	131	Bromoacetone	60 m (200 ft)	0.5 km (0.3 mi)	1.2 km (0.8 mi)	0.5 km (0.3 mi)	200 m (600 ft)	2.2 km (1.4 mi)	3.6 km (2.3 mi)	
1580	154	Chloropicrin	30 m (100 ft)	0.1 km (0.1 mi)	0.6 km (0.4 mi)	0.1 km (0.1 mi)	300 m (1000 ft)	2.1 km (1.3 mi)	5.9 km (3.7 mi)	
1581	123	Chloropicrin and Methyl bromide mixture	30 m (100 ft)	0.1 km (0.1 mi)	0.4 km (0.3 mi)	0.1 km (0.1 mi)	60 m (200 ft)	0.4 km (0.2 mi)	1.7 km (1.1 mi)	
1581	123	Methyl bromide and Chloropicrin mixture	30 m (100 ft)	0.1 km (0.1 mi)	0.4 km (0.3 mi)	0.1 km (0.1 mi)	60 m (200 ft)	0.4 km (0.2 mi)	1.7 km (1.1 mi)	
1582	119	Chloropicrin and Methyl chloride mixture	30 m (100 ft)	0.1 km (0.1 mi)	0.4 km (0.3 mi)	0.1 km (0.1 mi)	60 m (200 ft)	0.4 km (0.2 mi)	1.7 km (1.1 mi)	
1582	119	Methyl chloride and Chloropicrin mixture	30 m (100 ft)	0.1 km (0.1 mi)	0.4 km (0.3 mi)	0.1 km (0.1 mi)	60 m (200 ft)	0.4 km (0.2 mi)	1.7 km (1.1 mi)	
1583	154	Chloropicrin mixture, n.o.s.	60 m (200 ft)	0.5 km (0.3 mi)	1.2 km (0.8 mi)	0.5 km (0.3 mi)	200 m (600 ft)	2.2 km (1.4 mi)	3.6 km (2.3 mi)	

1589	125	Cyanogen chloride, stabilized	300 m (1000 ft)	1.8 km (1.2 mi)	6.4 km (4.0 mi)	1000 m (3000 ft)	9.7 km (6.0 mi)	11.0+ km (7.0+ mi)
1595	156	Dimethyl sulfate	30 m (100 ft)	0.2 km (0.1 mi)	0.2 km (0.1 mi)	60 m	0.5 km (0.3 mi)	0.6 km (0.4 mi)
1595	156	Dimethyl sulphate	30 m (100 ft)	0.1 km (0.1 mi)	0.1 km (0.1 mi)	30 m	0.1 km (0.1 mi)	0.2 km (0.1 mi)
1605	154	Ethylene dibromide	100 m (300 ft)	0.8 km (0.5 mi)	2.7 km (1.7 mi)	400 m (1250 ft)	3.5 km (2.2 mi)	8.1 km (5.1 mi)
1612	123	Compressed gas and hexaethyl tetraphosphate mixture						
1612	123	Hexaethyl tetraphosphate and compressed gas mixture						
1613	154	Hydrocyanic acid, aqueous solution, with not more than 20% Hydrogen cyanide	30 m (100 ft)	0.1 km (0.1 mi)	0.1 km (0.1 mi)	100 m (300 ft)	0.5 km (0.3 mi)	1.1 km (0.7 mi)
1613	154	Hydrogen cyanide, aqueous solution, with not more than 20% Hydrogen cyanide	60 m (200 ft)	0.2 km (0.1 mi)	0.6 km (0.4 mi)	150 m (500 ft)	0.5 km (0.3 mi)	1.5 km (0.9 mi)
1647	151	Ethylene dibromide and Methyl bromide mixture, liquid	30 m (100 ft)	0.1 km (0.1 mi)	0.1 km (0.1 mi)	150 m (500 ft)	0.3 km (0.2 mi)	0.8 km (0.5 mi)
1647	151	Methyl bromide and Ethylene dibromide mixture, liquid	30 m (100 ft)	0.1 km (0.1 mi)	0.6 km (0.4 mi)	100 m (300 ft)	0.6 km (0.4 mi)	2.2 km (1.4 mi)
1660	124	Nitric oxide	30 m (100 ft)	0.2 km (0.2 mi)	0.4 km (0.2 mi)	100 m (300 ft)	0.8 km (0.5 mi)	1.2 km (0.8 mi)
1660	124	Nitric oxide, compressed	30 m (100 ft)	0.2 km (0.1 mi)	0.2 km (0.1 mi)	60 m (200 ft)	0.5 km (0.3 mi)	0.7 km (0.4 mi)
1670	157	Perchloromethyl mercaptan	30 m (100 ft)	0.1 km (0.1 mi)	0.1 km (0.1 mi)	60 m (200 ft)	0.2 km (0.2 mi)	1.0 km (0.6 mi)
1672	151	Phenylcarbamylamine chloride	30 m (100 ft)	0.1 km (0.1 mi)	0.1 km (0.1 mi)	100 m (300 ft)	0.3 km (0.2 mi)	1.2 km (0.7 mi)
1680	157	Potassium cyanide, solid (when spilled in water)						
1689	157	Sodium cyanide, solid (when spilled in water)						

"+" means distance can be larger in certain atmospheric conditions

TABLE 1

TABLE 1 - INITIAL ISOLATION AND PROTECTIVE ACTION DISTANCES

		SMALL SPILLS (From a small package or small leak from a large package)				LARGE SPILLS (From a large package or from many small packages)				
ID No.	Guide	NAME OF MATERIAL	First ISOLATE in all Directions		Then PROTECT persons Downwind during		First ISOLATE in all Directions		Then PROTECT persons Downwind during	
			Meters (Feet)	Kilometers (Miles)	DAY Kilometers (Miles)	NIGHT Kilometers (Miles)	Meters (Feet)	Kilometers (Miles)	DAY Kilometers (Miles)	NIGHT Kilometers (Miles)
1695	131	Chloroacetone, stabilized	30 m (100 ft)	0.1 km (0.1 mi)	0.2 km (0.1 mi)	0.2 km (0.1 mi)	60 m (200 ft)	0.4 km (0.3 mi)	0.6 km (0.4 mi)	
1716	156	Acetyl bromide (when spilled in water)	30 m (100 ft)	0.1 km (0.1 mi)	0.1 km (0.1 mi)	0.1 km (0.1 mi)	30 m (100 ft)	0.3 km (0.2 mi)	0.9 km (0.6 mi)	
1717	155	Acetyl chloride (when spilled in water)	30 m (100 ft)	0.1 km (0.1 mi)	0.1 km (0.1 mi)	0.1 km (0.1 mi)	100 m (300 ft)	0.9 km (0.6 mi)	2.6 km (1.6 mi)	
1722	155	Allyl chloroacetate	100 m (300 ft)	0.3 km (0.2 mi)	0.8 km (0.5 mi)		400 m (1250 ft)	1.4 km (0.9 mi)	2.4 km (1.5 mi)	
1722	155	Allyl chloroformate								
1724	155	Allyltrichlorosilane, stabilized (when spilled in water)	30 m (100 ft)	0.1 km (0.1 mi)	0.1 km (0.1 mi)	0.1 km (0.1 mi)	60 m (200 ft)	0.5 km (0.3 mi)	1.7 km (1.1 mi)	
1725	137	Aluminum bromide, anhydrous (when spilled in water)	30 m (100 ft)	0.1 km (0.1 mi)	0.1 km (0.1 mi)	0.1 km (0.1 mi)	30 m (100 ft)	0.1 km (0.1 mi)	0.3 km (0.2 mi)	
1726	137	Aluminum chloride, anhydrous (when spilled in water)	30 m (100 ft)	0.1 km (0.1 mi)	0.2 km (0.1 mi)	0.2 km (0.1 mi)	60 m (200 ft)	0.5 km (0.3 mi)	2.0 km (1.2 mi)	
1728	155	Amyltrichlorosilane (when spilled in water)	30 m (100 ft)	0.1 km (0.1 mi)	0.1 km (0.1 mi)	0.1 km (0.1 mi)	60 m (200 ft)	0.5 km (0.3 mi)	1.7 km (1.0 mi)	
1732	157	Antimony pentafluoride (when spilled in water)	30 m (100 ft)	0.1 km (0.1 mi)	0.3 km (0.2 mi)	0.3 km (0.2 mi)	100 m (300 ft)	1.1 km (0.7 mi)	3.9 km (2.4 mi)	
1741	125	Boron trichloride (when spilled on land)	30 m (100 ft)	0.1 km (0.1 mi)	0.3 km (0.2 mi)	0.3 km (0.2 mi)	100 m (300 ft)	0.6 km (0.4 mi)	1.4 km (0.9 mi)	
1741	125	Boron trichloride (when spilled in water)	30 m (100 ft)	0.1 km (0.1 mi)	0.3 km (0.2 mi)	0.3 km (0.2 mi)	100 m (300 ft)	1.2 km (0.8 mi)	3.6 km (2.2 mi)	

1744	154	Bromine	60 m (200 ft)	0.8 km (0.5 mi)	2.3 km (1.5 mi)	300 m (1000 ft)	3.8 km (2.4 mi)	7.5 km (4.7 mi)
1744	154	Bromine, solution						
1744	154	Bromine, solution (Inhalation Hazard Zone A)	30 m (100 ft)	0.1 km (0.1 mi)	0.2 km (0.2 mi)	30 m (100 ft)	0.3 km (0.2 mi)	0.5 km (0.3 mi)
1744	154	Bromine, solution (Inhalation Hazard Zone B)	100 m (300 ft)	0.9 km (0.5 mi)	2.5 km (1.6 mi)	400 m (1250 ft)	5.4 km (3.3 mi)	10.7 km (6.6 mi)
1745	144	Bromine pentafluoride (when spilled on land)	30 m (100 ft)	0.1 km (0.1 mi)	0.3 km (0.2 mi)	150 m (500 ft)	1.2 km (0.7 mi)	4.0 km (2.5 mi)
1745	144	Bromine pentafluoride (when spilled in water)	30 m (100 ft)	0.1 km (0.1 mi)	0.2 km (0.1 mi)	30 m (100 ft)	0.3 km (0.2 mi)	0.4 km (0.3 mi)
1746	144	Bromine trifluoride (when spilled on land)	30 m (100 ft)	0.1 km (0.1 mi)	0.3 km (0.2 mi)	100 m (300 ft)	1.0 km (0.7 mi)	3.7 km (2.3 mi)
1746	144	Bromine trifluoride (when spilled in water)	30 m (100 ft)	0.1 km (0.1 mi)	0.1 km (0.1 mi)	60 m (200 ft)	0.5 km (0.3 mi)	1.6 km (1.0 mi)
1747	155	Butyltrichlorosilane (when spilled in water)	60 m (200 ft)	0.3 km (0.2 mi)	1.1 km (0.7 mi)	200 m (600 ft)	1.4 km (0.9 mi)	3.6 km (2.3 mi)
1749	124	Chlorine trifluoride	30 m (100 ft)	0.3 km (0.2 mi)	0.6 km (0.4 mi)	100 m (300 ft)	1.1 km (0.7 mi)	1.9 km (1.2 mi)
1752	156	Chloroacetyl chloride (when spilled on land)	30 m (100 ft)	0.1 km (0.1 mi)	0.1 km (0.1 mi)	30 m (100 ft)	0.2 km (0.1 mi)	0.6 km (0.4 mi)
1752	156	Chloroacetyl chloride (when spilled in water)	30 m (100 ft)	0.1 km (0.1 mi)	0.1 km (0.1 mi)	30 m (100 ft)	0.2 km (0.2 mi)	0.8 km (0.5 mi)
1753	156	Chlorophenyltrichlorosilane (when spilled in water)	30 m (100 ft)	0.1 km (0.1 mi)	0.1 km (0.1 mi)	30 m (100 ft)	0.2 km (0.2 mi)	0.3 km (0.2 mi)
1754	137	Chlorosulfonic acid (with or without sulfur trioxide) (when spilled on land)						

"+" means distance can be larger in certain atmospheric conditions

TABLE 1

TABLE 1 - INITIAL ISOLATION AND PROTECTIVE ACTION DISTANCES

		SMALL SPILLS (From a small package or small leak from a large package)			LARGE SPILLS (From a large package or from many small packages)			
ID No.	Guide	NAME OF MATERIAL	First ISOLATE	Then PROTECT		First ISOLATE	Then PROTECT	
			Meters (Feet) in all Directions	persons Downwind during DAY	NIGHT	Meters (Feet) in all Directions	persons Downwind during DAY	NIGHT
			Kilometers (Miles)	Kilometers (Miles)	Kilometers (Miles)	Kilometers (Miles)	Kilometers (Miles)	Kilometers (Miles)
1754	137	Chlorosulfonic acid (with or without sulfur trioxide) (when spilled in water)	30 m (100 ft)	0.1 km (0.1 mi)	0.1 km (0.1 mi)	60 m (200 ft)	0.7 km (0.4 mi)	2.3 km (1.4 mi)
1754	137	Chlorosulphonic acid (with or without sulphur trioxide) (when spilled on land)	30 m (100 ft)	0.1 km (0.1 mi)	0.1 km (0.1 mi)	30 m (100 ft)	0.2 km (0.2 mi)	0.3 km (0.2 mi)
1754	137	Chlorosulphonic acid (with or without sulphur trioxide) (when spilled in water)	30 m (100 ft)	0.1 km (0.1 mi)	0.1 km (0.1 mi)	60 m (200 ft)	0.7 km (0.4 mi)	2.3 km (1.4 mi)
1758	137	Chromium oxychloride (when spilled in water)	30 m (100 ft)	0.1 km (0.1 mi)	0.1 km (0.1 mi)	30 m (100 ft)	0.1 km (0.1 mi)	0.5 km (0.3 mi)
1762	156	Cyclohexenyltrichlorosilane (when spilled in water)	30 m (100 ft)	0.1 km (0.1 mi)	0.1 km (0.1 mi)	30 m (100 ft)	0.3 km (0.2 mi)	1.2 km (0.7 mi)
1763	156	Cyclohexyltrichlorosilane (when spilled in water)	30 m (100 ft)	0.1 km (0.1 mi)	0.1 km (0.1 mi)	30 m (100 ft)	0.3 km (0.2 mi)	1.2 km (0.7 mi)
1765	156	Dichloroacetyl chloride (when spilled in water)	30 m (100 ft)	0.1 km (0.1 mi)	0.1 km (0.1 mi)	30 m (100 ft)	0.2 km (0.1 mi)	0.7 km (0.5 mi)
1766	156	Dichlorophenyltrichlorosilane (when spilled in water)	30 m (100 ft)	0.1 km (0.1 mi)	0.1 km (0.1 mi)	60 m (200 ft)	0.5 km (0.4 mi)	2.0 km (1.2 mi)
1767	155	Diethylchlorosilane (when spilled in water)	30 m (100 ft)	0.1 km (0.1 mi)	0.1 km (0.1 mi)	30 m (100 ft)	0.3 km (0.2 mi)	0.9 km (0.5 mi)

1769	156	Diphenyldichlorosilane (when spilled in water)	30 m (100 ft)	0.1 km (0.1 mi)	0.1 km (0.1 mi)	0.1 km (0.1 mi)	30 m (100 ft)	0.3 km (0.2 mi)	1.1 km (0.7 mi)
1771	156	Dodecyltrichlorosilane (when spilled in water)	30 m (100 ft)	0.1 km (0.1 mi)	0.1 km (0.1 mi)	0.1 km (0.1 mi)	30 m (100 ft)	0.4 km (0.3 mi)	1.2 km (0.8 mi)
1777	137	Fluorosulfonic acid (when spilled in water)	30 m (100 ft)	0.1 km (0.1 mi)	0.1 km (0.1 mi)	0.1 km (0.1 mi)	30 m (100 ft)	0.2 km (0.1 mi)	0.5 km (0.3 mi)
1777	137	Fluorosulphonic acid (when spilled in water)	30 m (100 ft)	0.1 km (0.1 mi)	0.1 km (0.1 mi)	0.1 km (0.1 mi)	30 m (100 ft)	0.2 km (0.1 mi)	0.5 km (0.3 mi)
1781	156	Hexadecyltrichlorosilane (when spilled in water)	30 m (100 ft)	0.1 km (0.1 mi)	0.1 km (0.1 mi)	0.1 km (0.1 mi)	30 m (100 ft)	0.1 km (0.1 mi)	0.4 km (0.3 mi)
1784	156	Hexyltrichlorosilane (when spilled in water)	30 m (100 ft)	0.1 km (0.1 mi)	0.1 km (0.1 mi)	0.1 km (0.1 mi)	30 m (100 ft)	0.4 km (0.2 mi)	1.3 km (0.8 mi)
1799	156	Nonyltrichlorosilane (when spilled in water)	30 m (100 ft)	0.1 km (0.1 mi)	0.1 km (0.1 mi)	0.1 km (0.1 mi)	30 m (100 ft)	0.4 km (0.3 mi)	1.4 km (0.9 mi)
1800	156	Octadecyltrichlorosilane (when spilled in water)	30 m (100 ft)	0.1 km (0.1 mi)	0.1 km (0.1 mi)	0.1 km (0.1 mi)	30 m (100 ft)	0.4 km (0.3 mi)	1.3 km (0.8 mi)
1801	156	Octyltrichlorosilane (when spilled in water)	30 m (100 ft)	0.1 km (0.1 mi)	0.1 km (0.1 mi)	0.1 km (0.1 mi)	30 m (100 ft)	0.4 km (0.3 mi)	1.4 km (0.9 mi)
1804	156	Phenyltrichlorosilane (when spilled in water)	30 m (100 ft)	0.1 km (0.1 mi)	0.1 km (0.1 mi)	0.1 km (0.1 mi)	30 m (100 ft)	0.4 km (0.2 mi)	1.3 km (0.8 mi)
1806	137	Phosphorus pentachloride (when spilled in water)	30 m (100 ft)	0.1 km (0.1 mi)	0.1 km (0.1 mi)	0.1 km (0.1 mi)	30 m (100 ft)	0.3 km (0.2 mi)	1.3 km (0.8 mi)
1808	137	Phosphorus tribromide (when spilled in water)	30 m (100 ft)	0.1 km (0.1 mi)	0.1 km (0.1 mi)	0.1 km (0.1 mi)	30 m (100 ft)	0.4 km (0.3 mi)	1.5 km (0.9 mi)
1809	137	Phosphorus trichloride (when spilled on land)	30 m (100 ft)	0.2 km (0.2 mi)	0.6 km (0.4 mi)	0.4 km (0.2 mi)	100 m (300 ft)	1.0 km (0.7 mi)	2.1 km (1.3 mi)
1809	137	Phosphorus trichloride (when spilled in water)	30 m (100 ft)	0.1 km (0.1 mi)	0.1 km (0.1 mi)	0.1 km (0.1 mi)	60 m (200 ft)	0.7 km (0.4 mi)	2.4 km (1.5 mi)

"+" means distance can be larger in certain atmospheric conditions

TABLE 1

TABLE 1 - INITIAL ISOLATION AND PROTECTIVE ACTION DISTANCES

		SMALL SPILLS (From a small package or small leak from a large package)				LARGE SPILLS (From a large package or from many small packages)				
ID No.	Guide	NAME OF MATERIAL	First ISOLATE in all Directions		Then PROTECT persons Downwind during		First ISOLATE in all Directions		Then PROTECT persons Downwind during	
			Meters (Feet)	Kilometers (Miles)	DAY Kilometers (Miles)	NIGHT Kilometers (Miles)	Meters (Feet)	Kilometers (Miles)	DAY Kilometers (Miles)	NIGHT Kilometers (Miles)
1810	137	Phosphorus oxychloride (when spilled on land)	30 m (100 ft)	0.3 km (0.2 mi)	0.6 km (0.4 mi)	100 m (300 ft)	1.0 km (0.7 mi)	1.9 km (1.2 mi)		
1810	137	Phosphorus oxychloride (when spilled in water)	30 m (100 ft)	0.1 km (0.1 mi)	0.1 km (0.1 mi)	60 m (200 ft)	0.6 km (0.4 mi)	2.1 km (1.3 mi)		
1815	132	Propionyl chloride (when spilled in water)	30 m (100 ft)	0.1 km (0.1 mi)	0.1 km (0.1 mi)	30 m (100 ft)	0.2 km (0.1 mi)	0.5 km (0.3 mi)		
1816	155	Propyltrichlorosilane (when spilled in water)	30 m (100 ft)	0.1 km (0.1 mi)	0.1 km (0.1 mi)	60 m (200 ft)	0.5 km (0.3 mi)	1.9 km (1.2 mi)		
1818	157	Silicon tetrachloride (when spilled in water)	30 m (100 ft)	0.1 km (0.1 mi)	0.2 km (0.1 mi)	60 m (200 ft)	0.8 km (0.5 mi)	2.7 km (1.7 mi)		
1828	137	Sulfur chlorides (when spilled on land)	30 m (100 ft)	0.1 km (0.1 mi)	0.1 km (0.1 mi)	60 m (200 ft)	0.3 km (0.2 mi)	0.4 km (0.3 mi)		
1828	137	Sulfur chlorides (when spilled in water)	30 m (100 ft)	0.1 km (0.1 mi)	0.1 km (0.1 mi)	30 m (100 ft)	0.3 km (0.2 mi)	1.0 km (0.6 mi)		
1828	137	Sulphur chlorides (when spilled on land)	30 m (100 ft)	0.1 km (0.1 mi)	0.1 km (0.1 mi)	60 m (200 ft)	0.3 km (0.2 mi)	0.4 km (0.3 mi)		
1828	137	Sulphur chlorides (when spilled in water)	30 m (100 ft)	0.1 km (0.1 mi)	0.1 km (0.1 mi)	30 m (100 ft)	0.3 km (0.2 mi)	1.0 km (0.6 mi)		
1829	137	Sulfur trioxide, stabilized	60 m (200 ft)	0.4 km (0.2 mi)	1.0 km (0.6 mi)	300 m (1000 ft)	2.9 km (1.8 mi)	6.3 km (4.0 mi)		
1831	137	Sulfuric acid, fuming	60 m (200 ft)	0.4 km (0.2 mi)	1.0 km (0.6 mi)	300 m (1000 ft)	2.9 km (1.8 mi)	6.3 km (4.0 mi)		
1831	137	Sulphuric acid, fuming	60 m (200 ft)	0.4 km (0.2 mi)	1.0 km (0.6 mi)	300 m (1000 ft)	2.9 km (1.8 mi)	6.3 km (4.0 mi)		

1834	137	Sulfuryl chloride (when spilled on land)	30 m (100 ft)	0.2 km (0.1 mi)	0.4 km (0.3 mi)	60 m (200 ft)	0.8 km (0.5 mi)	1.5 km (0.9 mi)
1834	137	Sulfuryl chloride (when spilled in water)	30 m (100 ft)	0.1 km (0.1 mi)	0.1 km (0.1 mi)	30 m (100 ft)	0.4 km (0.3 mi)	1.6 km (1.0 mi)
1834	137	Sulphuryl chloride (when spilled on land)	30 m (100 ft)	0.2 km (0.1 mi)	0.4 km (0.3 mi)	60 m (200 ft)	0.8 km (0.5 mi)	1.5 km (0.9 mi)
1834	137	Sulphuryl chloride (when spilled in water)	30 m (100 ft)	0.1 km (0.1 mi)	0.1 km (0.1 mi)	30 m (100 ft)	0.4 km (0.3 mi)	1.6 km (1.0 mi)
1836	137	Thionyl chloride (when spilled on land)	30 m (100 ft)	0.1 km (0.1 mi)	0.2 km (0.2 mi)	30 m (100 ft)	0.3 km (0.2 mi)	0.5 km (0.3 mi)
1836	137	Thionyl chloride (when spilled in water)	100 m (300 ft)	0.9 km (0.6 mi)	2.9 km (1.8 mi)	800 m (2500 ft)	9.7 km (6.0 mi)	11.0+ km (7.0+ mi)
1838	137	Titanium tetrachloride (when spilled on land)	30 m (100 ft)	0.1 km (0.1 mi)	0.2 km (0.1 mi)	30 m (100 ft)	0.3 km (0.2 mi)	0.5 km (0.3 mi)
1838	137	Titanium tetrachloride (when spilled in water)	30 m (100 ft)	0.1 km (0.1 mi)	0.1 km (0.1 mi)	60 m (200 ft)	0.5 km (0.3 mi)	1.7 km (1.0 mi)
1859	125	Silicon tetrafluoride	30 m (100 ft)	0.2 km (0.1 mi)	0.8 km (0.5 mi)	100 m (300 ft)	0.5 km (0.3 mi)	1.8 km (1.2 mi)
1859	125	Silicon tetrafluoride, compressed	150 m (500 ft)	1.5 km (0.9 mi)	2.1 km (1.3 mi)	400 m (1250 ft)	4.6 km (2.9 mi)	6.4 km (4.0 mi)
1892	151	Ethyldichloroarsine	30 m (100 ft)	0.1 km (0.1 mi)	0.1 km (0.1 mi)	30 m (100 ft)	0.4 km (0.3 mi)	1.1 km (0.7 mi)
1898	156	Acetyl iodide (when spilled in water)	60 m (200 ft)	0.3 km (0.2 mi)	1.2 km (0.7 mi)	300 m (1000 ft)	1.5 km (1.0 mi)	4.6 km (2.9 mi)
1911	119	Diborane						
1911	119	Diborane, compressed						
1911	119	Diborane mixtures						

"+" means distance can be larger in certain atmospheric conditions

TABLE 1

TABLE 1 - INITIAL ISOLATION AND PROTECTIVE ACTION DISTANCES

ID No.	Guide	NAME OF MATERIAL	SMALL SPILLS (From a small package or small leak from a large package)				LARGE SPILLS (From a large package or from many small packages)			
			First ISOLATE in all Directions		Then PROTECT persons Downwind during		First ISOLATE in all Directions		Then PROTECT persons Downwind during	
			Meters (Feet)	Kilometers (Miles)	DAY Kilometers (Miles)	NIGHT Kilometers (Miles)	Meters (Feet)	Kilometers (Miles)	DAY Kilometers (Miles)	NIGHT Kilometers (Miles)
1923	135	Calcium dithionite (when spilled in water)	30 m (100 ft)	0.1 km (0.1 mi)	0.4 km (0.3 mi)	60 m (200 ft)	0.7 km (0.4 mi)	2.6 km (1.6 mi)		
1923	135	Calcium hydrosulfite (when spilled in water)	30 m (100 ft)	0.1 km (0.1 mi)	0.4 km (0.3 mi)	60 m (200 ft)	0.7 km (0.4 mi)	2.6 km (1.6 mi)		
1923	135	Calcium hydrosulphite (when spilled in water)	30 m (100 ft)	0.1 km (0.1 mi)	0.4 km (0.3 mi)	60 m (200 ft)	0.7 km (0.4 mi)	2.6 km (1.6 mi)		
1929	135	Potassium dithionite (when spilled in water)	30 m (100 ft)	0.1 km (0.1 mi)	0.4 km (0.2 mi)	60 m (200 ft)	0.6 km (0.4 mi)	2.3 km (1.5 mi)		
1929	135	Potassium hydrosulfite (when spilled in water)	30 m (100 ft)	0.1 km (0.1 mi)	0.4 km (0.2 mi)	60 m (200 ft)	0.6 km (0.4 mi)	2.3 km (1.5 mi)		
1929	135	Potassium hydrosulphite (when spilled in water)	30 m (100 ft)	0.1 km (0.1 mi)	0.4 km (0.2 mi)	60 m (200 ft)	0.6 km (0.4 mi)	2.3 km (1.5 mi)		
1931	171	Zinc dithionite (when spilled in water)	30 m (100 ft)	0.1 km (0.1 mi)	0.4 km (0.3 mi)	60 m (200 ft)	0.6 km (0.4 mi)	2.4 km (1.5 mi)		
1931	171	Zinc hydrosulfite (when spilled in water)	30 m (100 ft)	0.1 km (0.1 mi)	0.4 km (0.3 mi)	60 m (200 ft)	0.6 km (0.4 mi)	2.4 km (1.5 mi)		
1931	171	Zinc hydrosulphite (when spilled in water)	30 m (100 ft)	0.1 km (0.1 mi)	0.4 km (0.3 mi)	60 m (200 ft)	0.6 km (0.4 mi)	2.4 km (1.5 mi)		
1953	119	Compressed gas, poisonous, flammable, n.o.s.	150 m (500 ft)	1.0 km (0.6 mi)	3.8 km (2.4 mi)	1000 m (3000 ft)	5.7 km (3.6 mi)	10.1 km (6.3 mi)		
1953	119	Compressed gas, poisonous, flammable, n.o.s. (Inhalation Hazard Zone A)	30 m (100 ft)	0.1 km (0.1 mi)	0.4 km (0.2 mi)	300 m (1000 ft)	1.3 km (0.8 mi)	3.4 km (2.1 mi)		
1953	119	Compressed gas, poisonous, flammable, n.o.s. (Inhalation Hazard Zone B)								

1953	119	Compressed gas, poisonous, flammable, n.o.s. (Inhalation Hazard Zone C)	30 m (100 ft)	0.1 km (0.1 mi)	0.3 km (0.2 mi)	150 m (500 ft)	1.0 km (0.6 mi)	2.9 km (1.8 mi)
1953	119	Compressed gas, poisonous, flammable, n.o.s. (Inhalation Hazard Zone D)	30 m (100 ft)	0.1 km (0.1 mi)	0.2 km (0.1 mi)	150 m (500 ft)	0.8 km (0.5 mi)	2.0 km (1.3 mi)
1953	119	Compressed gas, toxic, flammable, n.o.s.						
1953	119	Compressed gas, toxic, flammable, n.o.s. (Inhalation Hazard Zone A)	150 m (500 ft)	1.0 km (0.6 mi)	3.8 km (2.4 mi)	1000 m (3000 ft)	5.7 km (3.6 mi)	10.1 km (6.3 mi)
1953	119	Compressed gas, toxic, flammable, n.o.s. (Inhalation Hazard Zone B)	30 m (100 ft)	0.1 km (0.1 mi)	0.4 km (0.2 mi)	300 m (1000 ft)	1.3 km (0.8 mi)	3.4 km (2.1 mi)
1953	119	Compressed gas, toxic, flammable, n.o.s. (Inhalation Hazard Zone C)	30 m (100 ft)	0.1 km (0.1 mi)	0.3 km (0.2 mi)	150 m (500 ft)	1.0 km (0.6 mi)	2.9 km (1.8 mi)
1953	119	Compressed gas, toxic, flammable, n.o.s. (Inhalation Hazard Zone D)	30 m (100 ft)	0.1 km (0.1 mi)	0.2 km (0.1 mi)	150 m (500 ft)	0.8 km (0.5 mi)	2.0 km (1.3 mi)
1955	123	Compressed gas, poisonous, n.o.s.						
1955	123	Compressed gas, poisonous, n.o.s. (Inhalation Hazard Zone A)	100 m (300 ft)	0.5 km (0.3 mi)	2.5 km (1.6 mi)	1000 m (3000 ft)	5.7 km (3.6 mi)	10.1 km (6.3 mi)
1955	123	Compressed gas, poisonous, n.o.s. (Inhalation Hazard Zone B)	30 m (100 ft)	0.2 km (0.1 mi)	0.9 km (0.6 mi)	400 m (1250 ft)	2.3 km (1.4 mi)	5.1 km (3.2 mi)
1955	123	Compressed gas, poisonous, n.o.s. (Inhalation Hazard Zone C)	30 m (100 ft)	0.1 km (0.1 mi)	0.3 km (0.2 mi)	150 m (500 ft)	1.0 km (0.6 mi)	2.9 km (1.8 mi)

"+" means distance can be larger in certain atmospheric conditions

TABLE 1

TABLE 1 - INITIAL ISOLATION AND PROTECTIVE ACTION DISTANCES

ID No.	Guide NAME OF MATERIAL	SMALL SPILLS (From a small package or small leak from a large package)				LARGE SPILLS (From a large package or from many small packages)			
		First ISOLATE in all Directions		Then PROTECT persons Downwind during		First ISOLATE in all Directions		Then PROTECT persons Downwind during	
		Meters (Feet)	Kilometers (Miles)	DAY Kilometers (Miles)	NIGHT Kilometers (Miles)	Meters (Feet)	Kilometers (Miles)	DAY Kilometers (Miles)	NIGHT Kilometers (Miles)
1955	123 Compressed gas, poisonous, n.o.s. (Inhalation Hazard Zone D)	30 m (100 ft)	0.1 km (0.1 mi)	0.2 km (0.1 mi)	0.1 km (0.1 mi)	150 m (500 ft)	0.8 km (0.5 mi)	2.0 km (1.3 mi)	
1955	123 Compressed gas, toxic, n.o.s.								
1955	123 Compressed gas, toxic, n.o.s. (Inhalation Hazard Zone A)	100 m (300 ft)	0.5 km (0.3 mi)	2.5 km (1.6 mi)	0.5 km (0.3 mi)	1000 m (3000 ft)	5.7 km (3.6 mi)	10.1 km (6.3 mi)	
1955	123 Compressed gas, toxic, n.o.s. (Inhalation Hazard Zone B)	30 m (100 ft)	0.2 km (0.1 mi)	0.9 km (0.6 mi)	0.2 km (0.1 mi)	400 m (1250 ft)	2.3 km (1.4 mi)	5.1 km (3.2 mi)	
1955	123 Compressed gas, toxic, n.o.s. (Inhalation Hazard Zone C)	30 m (100 ft)	0.1 km (0.1 mi)	0.3 km (0.2 mi)	0.1 km (0.1 mi)	150 m (500 ft)	1.0 km (0.6 mi)	2.9 km (1.8 mi)	
1955	123 Compressed gas, toxic, n.o.s. (Inhalation Hazard Zone D)	30 m (100 ft)	0.1 km (0.1 mi)	0.2 km (0.1 mi)	0.1 km (0.1 mi)	150 m (500 ft)	0.8 km (0.5 mi)	2.0 km (1.3 mi)	
1955	123 Organic phosphate compound mixed with compressed gas								
1955	123 Organic phosphate mixed with compressed gas	100 m (300 ft)	1.0 km (0.7 mi)	3.4 km (2.1 mi)	1.0 km (0.7 mi)	500 m (1500 ft)	4.4 km (2.7 mi)	9.6 km (6.0 mi)	
1955	123 Organic phosphorus compound mixed with compressed gas								
1967	123 Insecticide gas, poisonous, n.o.s.								
1967	123 Insecticide gas, toxic, n.o.s.	100 m (300 ft)	1.0 km (0.7 mi)	3.4 km (2.1 mi)	1.0 km (0.7 mi)	500 m (1500 ft)	4.4 km (2.7 mi)	9.6 km (6.0 mi)	
1967	123 Parathion and compressed gas mixture								

TABLE 1 - INITIAL ISOLATION AND PROTECTIVE ACTION DISTANCES

		SMALL SPILLS (From a small package or small leak from a large package)			LARGE SPILLS (From a large package or from many small packages)		
ID No.	Guide NAME OF MATERIAL	First ISOLATE in all Directions Meters (Feet)	Then PROTECT persons Downwind during		First ISOLATE in all Directions Meters (Feet)	Then PROTECT persons Downwind during	
			DAY Kilometers (Miles)	NIGHT Kilometers (Miles)		DAY Kilometers (Miles)	NIGHT Kilometers (Miles)
2195	125 Tellurium hexafluoride	1000 m (3000 ft)	5.8 km (3.6 mi)	10.9 km (6.8 mi)	1000 m (3000 ft)	11.0+ km (7.0+ mi)	11.0+ km (7.0+ mi)
2196	125 Tungsten hexafluoride	30 m (100 ft)	0.2 km (0.1 mi)	0.8 km (0.5 mi)	150 m (500 ft)	0.8 km (0.5 mi)	2.7 km (1.7 mi)
2197	125 Hydrogen iodide, anhydrous	30 m (100 ft)	0.1 km (0.1 mi)	0.3 km (0.2 mi)	150 m (500 ft)	1.0 km (0.6 mi)	2.9 km (1.8 mi)
2198	125 Phosphorus pentafluoride	30 m (100 ft)	0.2 km (0.2 mi)	1.0 km (0.7 mi)	150 m (500 ft)	1.0 km (0.6 mi)	3.5 km (2.2 mi)
2198	125 Phosphorus pentaffluoride, compressed	30 m (100 ft)	0.2 km (0.2 mi)	1.0 km (0.7 mi)	150 m (500 ft)	1.0 km (0.6 mi)	3.5 km (2.2 mi)
2199	119 Phosphine	60 m (200 ft)	0.3 km (0.2 mi)	1.1 km (0.7 mi)	300 m (1000 ft)	1.3 km (0.8 mi)	3.7 km (2.3 mi)
2202	117 Hydrogen selenide, anhydrous	300 m (1000 ft)	1.7 km (1.1 mi)	6.0 km (3.7 mi)	1000 m (3000 ft)	10.7 km (6.7 mi)	11.0+ km (7.0+ mi)
2204	119 Carbonyl sulfide	30 m (100 ft)	0.1 km (0.1 mi)	0.3 km (0.2 mi)	300 m (1000 ft)	1.6 km (1.0 mi)	3.8 km (2.4 mi)
2204	119 Carbonyl sulphide	30 m (100 ft)	0.1 km (0.1 mi)	0.3 km (0.2 mi)	300 m (1000 ft)	1.6 km (1.0 mi)	3.8 km (2.4 mi)
2232	153 Chloroacetaldehyde	30 m (100 ft)	0.2 km (0.1 mi)	0.3 km (0.2 mi)	60 m (200 ft)	0.6 km (0.4 mi)	1.1 km (0.7 mi)
2232	153 2-Chloroethanal	30 m (100 ft)	0.2 km (0.1 mi)	0.3 km (0.2 mi)	60 m (200 ft)	0.6 km (0.4 mi)	1.1 km (0.7 mi)
2285	156 Isocyanatobenzotrifluorides	30 m (100 ft)	0.1 km (0.1 mi)	0.2 km (0.1 mi)	30 m (100 ft)	0.4 km (0.3 mi)	0.6 km (0.4 mi)
2308	157 Nitrosylsulfuric acid, liquid (when spilled in water)	30 m (100 ft)	0.1 km (0.1 mi)	0.3 km (0.2 mi)	300 m (1000 ft)	1.0 km (0.6 mi)	2.9 km (1.8 mi)
2308	157 Nitrosylsulfuric acid, liquid (when spilled in water)	30 m (100 ft)	0.1 km (0.1 mi)	0.3 km (0.2 mi)	300 m (1000 ft)	1.0 km (0.6 mi)	2.9 km (1.8 mi)
2334	131 Allylamine	30 m (100 ft)	0.2 km (0.1 mi)	0.5 km (0.4 mi)	150 m (500 ft)	1.4 km (0.9 mi)	2.5 km (1.6 mi)
2337	131 Phenyl mercaptan	30 m (100 ft)	0.1 km (0.1 mi)	0.1 km (0.1 mi)	30 m (100 ft)	0.3 km (0.2 mi)	0.4 km (0.2 mi)
2353	132 Butyl chloride (when spilled in water)	30 m (100 ft)	0.1 km (0.1 mi)	0.1 km (0.1 mi)	30 m (100 ft)	0.3 km (0.2 mi)	0.7 km (0.5 mi)

2382	131	Dimethylhydrazine, symmetrical	30 m (100 ft)	0.2 km (0.1 mi)	0.3 km (0.2 mi)	60 m (200 ft)	0.7 km (0.5 mi)	1.3 km (0.8 mi)
2395	132	Isobutryl chloride (when spilled in water)	30 m (100 ft)	0.1 km (0.1 mi)	0.1 km (0.1 mi)	30 m (100 ft)	0.2 km (0.1 mi)	0.4 km (0.3 mi)
2407	155	Isopropyl chloroformate	30 m (100 ft)	0.1 km (0.1 mi)	0.2 km (0.2 mi)	60 m (200 ft)	0.5 km (0.3 mi)	0.9 km (0.6 mi)
2417	125	Carbonyl fluoride	150 m (500 ft)	0.7 km (0.5 mi)	2.5 km (1.6 mi)	600 m (2000 ft)	3.6 km (2.3 mi)	7.8 km (4.9 mi)
2417	125	Carbonyl fluoride, compressed						
2418	125	Sulfur tetrafluoride	100 m (300 ft)	0.5 km (0.3 mi)	2.3 km (1.5 mi)	400 m (1250 ft)	2.1 km (1.3 mi)	6.0 km (3.7 mi)
2418	125	Sulphur tetrafluoride						
2420	125	Hexafluoroacetone	100 m (300 ft)	0.7 km (0.4 mi)	2.7 km (1.7 mi)	1000 m (3000 ft)	11.0+ km (7.0+ mi)	11.0+ km (7.0+ mi)
2421	124	Nitrogen trioxide	60 m (200 ft)	0.3 km (0.2 mi)	1.2 km (0.7 mi)	200 m (600 ft)	1.2 km (0.8 mi)	4.2 km (2.6 mi)
2434	156	Dibenzylchlorosilane (when spilled in water)	30 m (100 ft)	0.1 km (0.1 mi)	0.1 km (0.1 mi)	30 m (100 ft)	0.1 km (0.1 mi)	0.4 km (0.3 mi)
2435	156	Ethylphenyldichlorosilane (when spilled in water)	30 m (100 ft)	0.1 km (0.1 mi)	0.1 km (0.1 mi)	30 m (100 ft)	0.3 km (0.2 mi)	0.9 km (0.6 mi)
2437	156	Methylphenyldichlorosilane (when spilled in water)	30 m (100 ft)	0.1 km (0.1 mi)	0.1 km (0.1 mi)	30 m (100 ft)	0.4 km (0.2 mi)	1.2 km (0.8 mi)
2438	131	Trimethylacetyl chloride	60 m (200 ft)	0.5 km (0.3 mi)	1.0 km (0.6 mi)	200 m (600 ft)	2.1 km (1.3 mi)	3.3 km (2.1 mi)
2442	156	Trichloroacetyl chloride	30 m (100 ft)	0.2 km (0.1 mi)	0.3 km (0.2 mi)	60 m (200 ft)	0.7 km (0.4 mi)	1.1 km (0.7 mi)
2474	157	Thiophosgene	60 m (200 ft)	0.6 km (0.4 mi)	1.7 km (1.1 mi)	200 m (600 ft)	2.1 km (1.3 mi)	4.0 km (2.5 mi)
2477	131	Methyl isothiocyanate	30 m (100 ft)	0.1 km (0.1 mi)	0.1 km (0.1 mi)	30 m (100 ft)	0.3 km (0.2 mi)	0.4 km (0.3 mi)

"+" means distance can be larger in certain atmospheric conditions

TABLE 1

TABLE 1 - INITIAL ISOLATION AND PROTECTIVE ACTION DISTANCES

		SMALL SPILLS (From a small package or small leak from a large package)		LARGE SPILLS (From a large package or from many small packages)			
ID No.	Guide	NAME OF MATERIAL	First ISOLATE	Then PROTECT	First ISOLATE	Then PROTECT	
			in all Directions	persons Downwind during	in all Directions	persons Downwind during	
			Meters (Feet)	DAY Kilometers (Miles)	NIGHT Kilometers (Miles)	DAY Kilometers (Miles)	NIGHT Kilometers (Miles)
2478	155	Isocyanate solution, flammable, poisonous, n.o.s.					
2478	155	Isocyanate solution, flammable, toxic, n.o.s.	60 m (200 ft)	0.8 km (0.5 mi)	1.8 km (1.1 mi)	400 m (1250 ft)	4.4 km (2.7 mi)
2478	155	Isocyanates, flammable, poisonous, n.o.s.					7.0 km (4.3 mi)
2478	155	Isocyanates, flammable, toxic, n.o.s.					
2480	155P	Methyl isocyanate	150 m (500 ft)	1.7 km (1.1 mi)	5.0 km (3.1 mi)	1000 m (3000 ft)	11.0+ km (7.0+ mi)
2481	155	Ethyl isocyanate	150 m (500 ft)	2.0 km (1.2 mi)	5.1 km (3.2 mi)	1000 m (3000 ft)	11.0+ km (7.0+ mi)
2482	155P	n-Propyl isocyanate	100 m (300 ft)	1.3 km (0.8 mi)	2.7 km (1.7 mi)	600 m (2000 ft)	7.4 km (4.6 mi)
2483	155P	Isopropyl isocyanate	150 m (500 ft)	1.5 km (0.9 mi)	3.2 km (2.0 mi)	1000 m (3000 ft)	11.0 km (6.9 mi)
2484	155	tert-Butyl isocyanate	60 m (200 ft)	0.8 km (0.5 mi)	1.8 km (1.1 mi)	400 m (1250 ft)	4.4 km (2.7 mi)
2485	155P	n-Butyl isocyanate	60 m (200 ft)	0.6 km (0.4 mi)	1.1 km (0.7 mi)	200 m (600 ft)	2.6 km (1.7 mi)
2486	155P	Isobutyl isocyanate	60 m (200 ft)	0.6 km (0.4 mi)	1.2 km (0.8 mi)	300 m (1000 ft)	3.1 km (1.9 mi)
2487	155	Phenyl isocyanate	100 m (300 ft)	0.9 km (0.6 mi)	1.4 km (0.9 mi)	300 m (1000 ft)	3.7 km (2.3 mi)
2488	155	Cyclohexyl isocyanate	30 m (100 ft)	0.3 km (0.2 mi)	0.4 km (0.3 mi)	100 m (300 ft)	1.0 km (0.6 mi)
2495	144	Iodine pentafluoride (when spilled in water)	30 m (100 ft)	0.1 km (0.1 mi)	0.3 km (0.2 mi)	100 m (300 ft)	1.1 km (0.7 mi)
2521	131P	Diketene, stabilized	30 m (100 ft)	0.2 km (0.1 mi)	0.3 km (0.2 mi)	60 m (200 ft)	0.6 km (0.4 mi)
2534	119	Methylchlorosilane	30 m (100 ft)	0.1 km (0.1 mi)	0.3 km (0.2 mi)	150 m (500 ft)	0.7 km (0.5 mi)

2548	124	Chlorine pentafluoride	100 m (300 ft)	0.5 km (0.3 mi)	2.5 km (1.6 mi)	800 m (2500 ft)	5.0 km (3.1 mi)	11.0+ km (7.0+ mi)
2605	155	Methoxymethyl isocyanate	30 m (100 ft)	0.2 km (0.1 mi)	0.2 km (0.2 mi)	60 m (200 ft)	0.6 km (0.4 mi)	0.9 km (0.6 mi)
2606	155	Methyl orthosilicate	30 m (100 ft)	0.2 km (0.1 mi)	0.3 km (0.2 mi)	60 m (200 ft)	0.7 km (0.4 mi)	1.1 km (0.7 mi)
2644	151	Methyl iodide	30 m (100 ft)	0.1 km (0.1 mi)	0.2 km (0.1 mi)	100 m (300 ft)	0.3 km (0.2 mi)	0.7 km (0.4 mi)
2646	151	Hexachlorocyclopentadiene	30 m (100 ft)	0.1 km (0.1 mi)	0.1 km (0.1 mi)	30 m (100 ft)	0.3 km (0.2 mi)	0.3 km (0.2 mi)
2668	131	Chloroacetonitrile	30 m (100 ft)	0.1 km (0.1 mi)	0.1 km (0.1 mi)	30 m (100 ft)	0.3 km (0.2 mi)	0.4 km (0.2 mi)
2676	119	Stibine	60 m (200 ft)	0.3 km (0.2 mi)	1.6 km (1.0 mi)	200 m (600 ft)	1.3 km (0.8 mi)	4.1 km (2.6 mi)
2691	137	Phosphorus pentabromide (when spilled in water)	30 m (100 ft)	0.1 km (0.1 mi)	0.1 km (0.1 mi)	30 m (100 ft)	0.1 km (0.1 mi)	0.5 km (0.3 mi)
2692	157	Boron tribromide (when spilled on land)	30 m (100 ft)	0.1 km (0.1 mi)	0.2 km (0.1 mi)	30 m (100 ft)	0.2 km (0.1 mi)	0.4 km (0.3 mi)
2692	157	Boron tribromide (when spilled in water)	30 m (100 ft)	0.1 km (0.1 mi)	0.2 km (0.1 mi)	60 m (200 ft)	0.5 km (0.3 mi)	1.9 km (1.2 mi)
2740	155	n-Propyl chloroformate	30 m (100 ft)	0.1 km (0.1 mi)	0.3 km (0.2 mi)	60 m (200 ft)	0.6 km (0.4 mi)	1.0 km (0.7 mi)
2742	155	sec-Butyl chloroformate	30 m (100 ft)	0.1 km (0.1 mi)	0.2 km (0.1 mi)	30 m (100 ft)	0.4 km (0.2 mi)	0.5 km (0.3 mi)
2742	155	Chloroformates, poisonous, corrosive, flammable, n.o.s. Chloroformates, toxic, corrosive, flammable, n.o.s.	30 m (100 ft)	0.2 km (0.1 mi)	0.2 km (0.2 mi)	60 m (200 ft)	0.5 km (0.3 mi)	0.7 km (0.5 mi)
2742	155	Isobutyl chloroformate	30 m (100 ft)	0.1 km (0.1 mi)	0.1 km (0.1 mi)	30 m (100 ft)	0.3 km (0.2 mi)	0.5 km (0.3 mi)
2743	155	n-Butyl chloroformate	30 m (100 ft)	0.1 km (0.1 mi)	0.1 km (0.1 mi)	30 m (100 ft)	0.3 km (0.2 mi)	0.4 km (0.3 mi)
2806	139	Lithium nitride (when spilled in water)	30 m (100 ft)	0.1 km (0.1 mi)	0.2 km (0.2 mi)	60 m (200 ft)	0.5 km (0.3 mi)	1.9 km (1.2 mi)
2826	155	Ethyl chloroethoformate	30 m (100 ft)	0.2 km (0.1 mi)	0.2 km (0.2 mi)	60 m (200 ft)	0.5 km (0.3 mi)	0.7 km (0.5 mi)
2845	135	Ethyl phosphonous dichloride, anhydrous	30 m (100 ft)	0.3 km (0.2 mi)	0.7 km (0.5 mi)	100 m (300 ft)	1.3 km (0.8 mi)	2.3 km (1.5 mi)

"+" means distance can be larger in certain atmospheric conditions

TABLE 1

TABLE 1 - INITIAL ISOLATION AND PROTECTIVE ACTION DISTANCES

		SMALL SPILLS (From a small package or small leak from a large package)			LARGE SPILLS (From a large package or from many small packages)			
ID No.	Guide	NAME OF MATERIAL	First ISOLATE	Then PROTECT		First ISOLATE	Then PROTECT	
			Meters (Feet) in all Directions	persons Downwind during DAY	Kilometers (Miles)	NIGHT	Meters (Feet) in all Directions	persons Downwind during DAY
2845	135	Methyl phosphorous dichloride	30 m (100 ft)	0.4 km (0.3 mi)	1.1 km (0.7 mi)	200 m (600 ft)	2.4 km (1.5 mi)	4.1 km (2.6 mi)
2901	124	Bromine chloride	100 m (300 ft)	0.5 km (0.3 mi)	1.8 km (1.1 mi)	1000 m (3000 ft)	5.4 km (3.4 mi)	11.0+ km (7.0+ mi)
2927	154	Ethyl phosphonothioic dichloride, anhydrous	30 m (100 ft)	0.1 km (0.1 mi)	0.1 km (0.1 mi)	30 m (100 ft)	0.2 km (0.1 mi)	0.2 km (0.1 mi)
2927	154	Ethyl phosphorodichloridate	30 m (100 ft)	0.1 km (0.1 mi)	0.1 km (0.1 mi)	30 m (100 ft)	0.3 km (0.2 mi)	0.3 km (0.2 mi)
2965	139	Boron trifluoride dimethyl etherate (when spilled in water)	30 m (100 ft)	0.1 km (0.1 mi)	0.3 km (0.2 mi)	100 m (300 ft)	1.2 km (0.8 mi)	3.6 km (2.2 mi)
2977	166	Radioactive material, Uranium hexafluoride, fissile (when spilled in water)	30 m (100 ft)	0.1 km (0.1 mi)	0.2 km (0.1 mi)	60 m (200 ft)	0.4 km (0.3 mi)	2.1 km (1.3 mi)
2977	166	Uranium hexafluoride, radioactive material, fissile (when spilled in water)	30 m (100 ft)	0.1 km (0.1 mi)	0.2 km (0.1 mi)	60 m (200 ft)	0.4 km (0.3 mi)	2.1 km (1.3 mi)
2978	166	Radioactive material, Uranium hexafluoride, non fissile or fissile-excepted (when spilled in water)	30 m (100 ft)	0.1 km (0.1 mi)	0.2 km (0.1 mi)	60 m (200 ft)	0.4 km (0.3 mi)	2.1 km (1.3 mi)
2978	166	Uranium hexafluoride, radioactive material, non fissile or fissile-excepted (when spilled in water)	30 m (100 ft)	0.1 km (0.1 mi)	0.2 km (0.1 mi)	60 m (200 ft)	0.4 km (0.3 mi)	2.1 km (1.3 mi)

2985	155	Chlorosilanes, flammable, corrosive, n.o.s. (when spilled in water)	30 m (100 ft)	0.1 km (0.1 mi)	0.2 km (0.1 mi)	0.1 km (0.1 mi)	60 m (200 ft)	0.5 km (0.3 mi)	1.6 km (1.0 mi)
2986	155	Chlorosilanes, corrosive, flammable, n.o.s. (when spilled in water)	30 m (100 ft)	0.1 km (0.1 mi)	0.2 km (0.1 mi)	0.1 km (0.1 mi)	60 m (200 ft)	0.5 km (0.3 mi)	1.6 km (1.0 mi)
2987	156	Chlorosilanes, corrosive, n.o.s. (when spilled in water)	30 m (100 ft)	0.1 km (0.1 mi)	0.2 km (0.1 mi)	0.1 km (0.1 mi)	60 m (200 ft)	0.5 km (0.3 mi)	1.6 km (1.0 mi)
2988	139	Chlorosilanes, water-reactive, flammable, corrosive, n.o.s. (when spilled in water)	30 m (100 ft)	0.1 km (0.1 mi)	0.2 km (0.1 mi)	0.1 km (0.1 mi)	60 m (200 ft)	0.5 km (0.3 mi)	1.6 km (1.0 mi)
3023	131	2-Methyl-2-heptanethiol	30 m (100 ft)	0.2 km (0.1 mi)	0.2 km (0.1 mi)	0.1 km (0.1 mi)	60 m (200 ft)	0.5 km (0.4 mi)	0.8 km (0.5 mi)
3048	157	Aluminum phosphide pesticide (when spilled in water)	30 m (100 ft)	0.1 km (0.1 mi)	0.7 km (0.5 mi)	0.1 km (0.1 mi)	500 m (1500 ft)	2.0 km (1.3 mi)	6.5 km (4.1 mi)
3057	125	Trifluoroacetyl chloride	30 m (100 ft)	0.2 km (0.1 mi)	0.9 km (0.6 mi)	0.2 km (0.1 mi)	800 m (2500 ft)	5.2 km (3.3 mi)	11.0+ km (7.0+ mi)
3079	131P	Methacrylonitrile, stabilized	30 m (100 ft)	0.3 km (0.2 mi)	0.7 km (0.5 mi)	0.3 km (0.2 mi)	150 m (500 ft)	1.6 km (1.0 mi)	2.7 km (1.7 mi)
3083	124	Perchloryl fluoride	30 m (100 ft)	0.2 km (0.2 mi)	1.1 km (0.7 mi)	0.2 km (0.2 mi)	1000 m (3000 ft)	5.5 km (3.4 mi)	11.0+ km (7.0+ mi)
3160	119	Liquefied gas, poisonous, flammable, n.o.s.							
3160	119	Liquefied gas, poisonous, flammable, n.o.s. (Inhalation Hazard Zone A)	150 m (500 ft)	1.0 km (0.6 mi)	3.8 km (2.4 mi)	1.0 km (0.6 mi)	1000 m (3000 ft)	5.7 km (3.6 mi)	10.1 km (6.3 mi)
3160	119	Liquefied gas, poisonous, flammable, n.o.s. (Inhalation Hazard Zone B)	30 m (100 ft)	0.1 km (0.1 mi)	0.4 km (0.2 mi)	0.1 km (0.1 mi)	300 m (1000 ft)	1.3 km (0.8 mi)	3.4 km (2.1 mi)
3160	119	Liquefied gas, poisonous, flammable, n.o.s. (Inhalation Hazard Zone C)	30 m (100 ft)	0.1 km (0.1 mi)	0.3 km (0.2 mi)	0.1 km (0.1 mi)	150 m (500 ft)	1.0 km (0.6 mi)	2.9 km (1.8 mi)

"+" means distance can be larger in certain atmospheric conditions

TABLE 1

TABLE 1 - INITIAL ISOLATION AND PROTECTIVE ACTION DISTANCES

ID No.	Guide NAME OF MATERIAL	SMALL SPILLS (From a small package or small leak from a large package)				LARGE SPILLS (From a large package or from many small packages)			
		First ISOLATE in all Directions		Then PROTECT persons Downwind during		First ISOLATE in all Directions		Then PROTECT persons Downwind during	
		Meters (Feet)	Kilometers (Miles)	DAY Kilometers (Miles)	NIGHT Kilometers (Miles)	Meters (Feet)	Kilometers (Miles)	DAY Kilometers (Miles)	NIGHT Kilometers (Miles)
3160	119 Liquefied gas, poisonous, flammable, n.o.s. (Inhalation Hazard Zone D)	30 m (100 ft)	0.1 km (0.1 mi)	0.2 km (0.1 mi)	150 m (500 ft)	0.8 km (0.5 mi)	2.0 km (1.3 mi)		
3160	119 Liquefied gas, toxic, flammable, n.o.s.								
3160	119 Liquefied gas, toxic, flammable, n.o.s. (Inhalation Hazard Zone A)	150 m (500 ft)	1.0 km (0.6 mi)	3.8 km (2.4 mi)	1000 m (3000 ft)	5.7 km (3.6 mi)	10.1 km (6.3 mi)		
3160	119 Liquefied gas, toxic, flammable, n.o.s. (Inhalation Hazard Zone B)	30 m (100 ft)	0.1 km (0.1 mi)	0.4 km (0.2 mi)	300 m (1000 ft)	1.3 km (0.8 mi)	3.4 km (2.1 mi)		
3160	119 Liquefied gas, toxic, flammable, n.o.s. (Inhalation Hazard Zone C)	30 m (100 ft)	0.1 km (0.1 mi)	0.3 km (0.2 mi)	150 m (500 ft)	1.0 km (0.6 mi)	2.9 km (1.8 mi)		
3160	119 Liquefied gas, toxic, flammable, n.o.s. (Inhalation Hazard Zone D)	30 m (100 ft)	0.1 km (0.1 mi)	0.2 km (0.1 mi)	150 m (500 ft)	0.8 km (0.5 mi)	2.0 km (1.3 mi)		
3162	123 Liquefied gas, poisonous, n.o.s.								
3162	123 Liquefied gas, poisonous, n.o.s. (Inhalation Hazard Zone A)	100 m (300 ft)	0.5 km (0.3 mi)	2.5 km (1.6 mi)	1000 m (3000 ft)	5.7 km (3.6 mi)	10.1 km (6.3 mi)		
3162	123 Liquefied gas, poisonous, n.o.s. (Inhalation Hazard Zone B)	30 m (100 ft)	0.2 km (0.1 mi)	0.9 km (0.6 mi)	400 m (1250 ft)	2.3 km (1.4 mi)	5.1 km (3.2 mi)		
3162	123 Liquefied gas, poisonous, n.o.s. (Inhalation Hazard Zone C)	30 m (100 ft)	0.1 km (0.1 mi)	0.3 km (0.2 mi)	150 m (500 ft)	1.0 km (0.6 mi)	2.9 km (1.8 mi)		

3162	123	Liquefied gas, poisonous, n.o.s. (Inhalation Hazard Zone D)	30 m (100 ft)	0.1 km (0.1 mi)	0.2 km (0.1 mi)	150 m (500 ft)	0.8 km (0.5 mi)	2.0 km (1.3 mi)
3162	123	Liquefied gas, toxic, n.o.s.	100 m (300 ft)	0.5 km (0.3 mi)	2.5 km (1.6 mi)	1000 m (3000 ft)	5.7 km (3.6 mi)	10.1 km (6.3 mi)
3162	123	Liquefied gas, toxic, n.o.s. (Inhalation Hazard Zone A)						
3162	123	Liquefied gas, toxic, n.o.s. (Inhalation Hazard Zone B)	30 m (100 ft)	0.2 km (0.1 mi)	0.9 km (0.6 mi)	400 m (1250 ft)	2.3 km (1.4 mi)	5.1 km (3.2 mi)
3162	123	Liquefied gas, toxic, n.o.s. (Inhalation Hazard Zone C)	30 m (100 ft)	0.1 km (0.1 mi)	0.3 km (0.2 mi)	150 m (500 ft)	1.0 km (0.6 mi)	2.9 km (1.8 mi)
3162	123	Liquefied gas, toxic, n.o.s. (Inhalation Hazard Zone D)	30 m (100 ft)	0.1 km (0.1 mi)	0.2 km (0.1 mi)	150 m (500 ft)	0.8 km (0.5 mi)	2.0 km (1.3 mi)
3246	156	Methanesulfonyl chloride	30 m (100 ft)	0.2 km (0.2 mi)	0.3 km (0.2 mi)	60 m (200 ft)	0.7 km (0.4 mi)	0.9 km (0.6 mi)
3246	156	Methanesulphonyl chloride	30 m (100 ft)	0.2 km (0.2 mi)	0.3 km (0.2 mi)	150 m (500 ft)	1.6 km (1.0 mi)	2.7 km (1.7 mi)
3275	131	Nitriles, poisonous, flammable, n.o.s.	30 m (100 ft)	0.3 km (0.2 mi)	0.7 km (0.5 mi)	150 m (500 ft)	1.6 km (1.0 mi)	2.7 km (1.7 mi)
3275	131	Nitriles, toxic, flammable, n.o.s.						
3276	151	Nitriles, liquid, poisonous, n.o.s.						
3276	151	Nitriles, liquid, toxic, n.o.s.	30 m (100 ft)	0.3 km (0.2 mi)	0.7 km (0.5 mi)	150 m (500 ft)	1.6 km (1.0 mi)	2.7 km (1.7 mi)
3276	151	Nitriles, poisonous, liquid, n.o.s.						
3276	151	Nitriles, toxic, liquid, n.o.s.	30 m (100 ft)	0.4 km (0.3 mi)	1.1 km (0.7 mi)	200 m (600 ft)	2.4 km (1.5 mi)	4.1 km (2.6 mi)
3278	151	Organophosphorus compound, liquid, poisonous, n.o.s.	30 m (100 ft)	0.4 km (0.3 mi)	1.1 km (0.7 mi)	200 m (600 ft)	2.4 km (1.5 mi)	4.1 km (2.6 mi)
3278	151	Organophosphorus compound, liquid, toxic, n.o.s.						
3278	151	Organophosphorus compound, poisonous, liquid, n.o.s.	30 m (100 ft)	0.4 km (0.3 mi)	1.1 km (0.7 mi)	200 m (600 ft)	2.4 km (1.5 mi)	4.1 km (2.6 mi)
3278	151	Organophosphorus compound, toxic, liquid, n.o.s.						

"+" means distance can be larger in certain atmospheric conditions

TABLE 1

TABLE 1 - INITIAL ISOLATION AND PROTECTIVE ACTION DISTANCES

ID No.	Guide NAME OF MATERIAL	SMALL SPILLS (From a small package or small leak from a large package)				LARGE SPILLS (From a large package or from many small packages)			
		First ISOLATE in all Directions		Then PROTECT persons Downwind during		First ISOLATE in all Directions		Then PROTECT persons Downwind during	
		Meters (Feet)	Kilometers (Miles)	DAY Kilometers (Miles)	NIGHT Kilometers (Miles)	Meters (Feet)	Kilometers (Miles)	DAY Kilometers (Miles)	NIGHT Kilometers (Miles)
3279	131 Organophosphorus compound, poisonous, flammable, n.o.s.	30 m (100 ft)	0.4 km (0.3 mi)	1.1 km (0.7 mi)	200 m (600 ft)	2.4 km (1.5 mi)	4.1 km (2.6 mi)		
3279	131 Organophosphorus compound, toxic, flammable, n.o.s.	30 m (100 ft)	0.2 km (0.1 mi)	0.7 km (0.4 mi)	150 m (500 ft)	1.6 km (1.0 mi)	3.6 km (2.2 mi)		
3280	151 Organoarsenic compound, liquid, n.o.s.	100 m (300 ft)	1.3 km (0.8 mi)	5.0 km (3.1 mi)	1000 m (3000 ft)	10.8 km (6.8 mi)	11.0+ km (7.0+ mi)		
3294	131 Hydrogen cyanide, solution in alcohol, with not more than 45% Hydrogen cyanide	30 m (100 ft)	0.1 km (0.1 mi)	0.3 km (0.2 mi)	200 m (600 ft)	0.5 km (0.3 mi)	1.9 km (1.2 mi)		
3300	119P Carbon dioxide and Ethylene oxide mixture, with more than 87% Ethylene oxide	30 m (100 ft)	0.1 km (0.1 mi)	0.2 km (0.2 mi)	150 m (500 ft)	0.8 km (0.5 mi)	2.2 km (1.4 mi)		
3300	119P Ethylene oxide and Carbon dioxide mixture, with more than 87% Ethylene oxide	30 m (100 ft)	0.1 km (0.1 mi)	0.2 km (0.2 mi)	150 m (500 ft)	0.8 km (0.5 mi)	2.2 km (1.4 mi)		
3303	124 Compressed gas, poisonous, oxidizing, n.o.s.	100 m (300 ft)	0.5 km (0.3 mi)	2.5 km (1.6 mi)	800 m (2500 ft)	5.0 km (3.1 mi)	11.0+ km (7.0+ mi)		
3303	124 Compressed gas, poisonous, oxidizing, n.o.s. (Inhalation Hazard Zone A)	60 m (200 ft)	0.3 km (0.2 mi)	1.1 km (0.7 mi)	400 m (1250 ft)	2.5 km (1.5 mi)	6.7 km (4.2 mi)		
3303	124 Compressed gas, poisonous, oxidizing, n.o.s. (Inhalation Hazard Zone B)								

3303	124	Compressed gas, poisonous, oxidizing, n.o.s. (Inhalation Hazard Zone C)	30 m (100 ft)	0.1 km (0.1 mi)	0.3 km (0.2 mi)	150 m (500 ft)	1.0 km (0.6 mi)	2.9 km (1.8 mi)
3303	124	Compressed gas, poisonous, oxidizing, n.o.s. (Inhalation Hazard Zone D)	30 m (100 ft)	0.1 km (0.1 mi)	0.2 km (0.1 mi)	150 m (500 ft)	0.8 km (0.5 mi)	2.0 km (1.3 mi)
3303	124	Compressed gas, toxic, oxidizing, n.o.s.						
3303	124	Compressed gas, toxic, oxidizing, n.o.s. (Inhalation Hazard Zone A)	100 m (300 ft)	0.5 km (0.3 mi)	2.5 km (1.6 mi)	800 m (2500 ft)	5.0 km (3.1 mi)	11.0+ km (7.0+ mi)
3303	124	Compressed gas, toxic, oxidizing, n.o.s. (Inhalation Hazard Zone B)	60 m (200 ft)	0.3 km (0.2 mi)	1.1 km (0.7 mi)	400 m (1250 ft)	2.5 km (1.5 mi)	6.7 km (4.2 mi)
3303	124	Compressed gas, toxic, oxidizing, n.o.s. (Inhalation Hazard Zone C)	30 m (100 ft)	0.1 km (0.1 mi)	0.3 km (0.2 mi)	150 m (500 ft)	1.0 km (0.6 mi)	2.9 km (1.8 mi)
3303	124	Compressed gas, toxic, oxidizing, n.o.s. (Inhalation Hazard Zone D)	30 m (100 ft)	0.1 km (0.1 mi)	0.2 km (0.1 mi)	150 m (500 ft)	0.8 km (0.5 mi)	2.0 km (1.3 mi)
3304	125	Compressed gas, poisonous, corrosive, n.o.s.						
3304	125	Compressed gas, poisonous, corrosive, n.o.s. (Inhalation Hazard Zone A)	100 m (300 ft)	0.5 km (0.3 mi)	2.5 km (1.6 mi)	500 m (1500 ft)	2.9 km (1.8 mi)	9.2 km (5.7 mi)
3304	125	Compressed gas, poisonous, corrosive, n.o.s. (Inhalation Hazard Zone B)	30 m (100 ft)	0.2 km (0.2 mi)	1.0 km (0.7 mi)	400 m (1250 ft)	2.3 km (1.4 mi)	5.1 km (3.2 mi)
3304	125	Compressed gas, poisonous, corrosive, n.o.s. (Inhalation Hazard Zone C)	30 m (100 ft)	0.1 km (0.1 mi)	0.5 km (0.3 mi)	300 m (1000 ft)	1.6 km (1.0 mi)	3.2 km (2.0 mi)

"+" means distance can be larger in certain atmospheric conditions

TABLE 1

TABLE 1 - INITIAL ISOLATION AND PROTECTIVE ACTION DISTANCES

ID No.	Guide NAME OF MATERIAL	SMALL SPILLS (From a small package or small leak from a large package)				LARGE SPILLS (From a large package or from many small packages)			
		First ISOLATE in all Directions		Then PROTECT persons Downwind during		First ISOLATE in all Directions		Then PROTECT persons Downwind during	
		Meters (Feet)	Kilometers (Miles)	DAY Kilometers (Miles)	NIGHT Kilometers (Miles)	Meters (Feet)	Kilometers (Miles)	DAY Kilometers (Miles)	NIGHT Kilometers (Miles)
3304	125 Compressed gas, poisonous, corrosive, n.o.s. (Inhalation Hazard Zone D)	30 m (100 ft)	0.1 km (0.1 mi)	0.2 km (0.1 mi)	150 m (500 ft)	0.8 km (0.5 mi)	2.0 km (1.3 mi)		
3304	125 Compressed gas, toxic, corrosive, n.o.s.								
3304	125 Compressed gas, toxic, corrosive, n.o.s. (Inhalation Hazard Zone A)	100 m (300 ft)	0.5 km (0.3 mi)	2.5 km (1.6 mi)	500 m (1500 ft)	2.9 km (1.8 mi)	9.2 km (5.7 mi)		
3304	125 Compressed gas, toxic, corrosive, n.o.s. (Inhalation Hazard Zone B)	30 m (100 ft)	0.2 km (0.2 mi)	1.0 km (0.7 mi)	400 m (1250 ft)	2.3 km (1.4 mi)	5.1 km (3.2 mi)		
3304	125 Compressed gas, toxic, corrosive, n.o.s. (Inhalation Hazard Zone C)	30 m (100 ft)	0.1 km (0.1 mi)	0.5 km (0.3 mi)	300 m (1000 ft)	1.6 km (1.0 mi)	3.2 km (2.0 mi)		
3304	125 Compressed gas, toxic, corrosive, n.o.s. (Inhalation Hazard Zone D)	30 m (100 ft)	0.1 km (0.1 mi)	0.2 km (0.1 mi)	150 m (500 ft)	0.8 km (0.5 mi)	2.0 km (1.3 mi)		
3305	119 Compressed gas, poisonous, flammable, corrosive, n.o.s.								
3305	119 Compressed gas, poisonous, flammable, corrosive, n.o.s. (Inhalation Hazard Zone A)	100 m (300 ft)	0.5 km (0.3 mi)	2.5 km (1.6 mi)	500 m (1500 ft)	2.9 km (1.8 mi)	9.2 km (5.7 mi)		

3305	119	Compressed gas, poisonous, flammable, corrosive, n.o.s. (Inhalation Hazard Zone B)	30 m (100 ft)	0.2 km (0.2 mi)	1.0 km (0.7 mi)	400 m (1250 ft)	2.3 km (1.4 mi)	5.1 km (3.2 mi)
3305	119	Compressed gas, poisonous, flammable, corrosive, n.o.s. (Inhalation Hazard Zone C)	30 m (100 ft)	0.1 km (0.1 mi)	0.5 km (0.3 mi)	300 m (1000 ft)	1.6 km (1.0 mi)	3.2 km (2.0 mi)
3305	119	Compressed gas, poisonous, flammable, corrosive, n.o.s. (Inhalation Hazard Zone D)	30 m (100 ft)	0.1 km (0.1 mi)	0.2 km (0.1 mi)	150 m (500 ft)	0.8 km (0.5 mi)	2.0 km (1.3 mi)
3305	119	Compressed gas, toxic, flammable, corrosive, n.o.s.						
3305	119	Compressed gas, toxic, flammable, corrosive, n.o.s. (Inhalation Hazard Zone A)	100 m (300 ft)	0.5 km (0.3 mi)	2.5 km (1.6 mi)	500 m (1500 ft)	2.9 km (1.8 mi)	9.2 km (5.7 mi)
3305	119	Compressed gas, toxic, flammable, corrosive, n.o.s. (Inhalation Hazard Zone B)	30 m (100 ft)	0.2 km (0.2 mi)	1.0 km (0.7 mi)	400 m (1250 ft)	2.3 km (1.4 mi)	5.1 km (3.2 mi)
3305	119	Compressed gas, toxic, flammable, corrosive, n.o.s. (Inhalation Hazard Zone C)	30 m (100 ft)	0.1 km (0.1 mi)	0.5 km (0.3 mi)	300 m (1000 ft)	1.6 km (1.0 mi)	3.2 km (2.0 mi)
3305	119	Compressed gas, toxic, flammable, corrosive, n.o.s. (Inhalation Hazard Zone D)	30 m (100 ft)	0.1 km (0.1 mi)	0.2 km (0.1 mi)	150 m (500 ft)	0.8 km (0.5 mi)	2.0 km (1.3 mi)
3306	124	Compressed gas, poisonous, oxidizing, corrosive, n.o.s.						
3306	124	Compressed gas, poisonous, oxidizing, corrosive, n.o.s. (Inhalation Hazard Zone A)	100 m (300 ft)	0.5 km (0.3 mi)	2.5 km (1.6 mi)	500 m (1500 ft)	2.9 km (1.8 mi)	9.2 km (5.7 mi)
3306	124	Compressed gas, poisonous, oxidizing, corrosive, n.o.s. (Inhalation Hazard Zone B)	30 m (100 ft)	0.2 km (0.2 mi)	1.0 km (0.7 mi)	400 m (1250 ft)	2.3 km (1.4 mi)	5.1 km (3.2 mi)

"+" means distance can be larger in certain atmospheric conditions

TABLE 1

TABLE 1 - INITIAL ISOLATION AND PROTECTIVE ACTION DISTANCES

ID No.	Guide NAME OF MATERIAL	SMALL SPILLS (From a small package or small leak from a large package)				LARGE SPILLS (From a large package or from many small packages)			
		First ISOLATE in all Directions		Then PROTECT persons Downwind during		First ISOLATE in all Directions		Then PROTECT persons Downwind during	
		Meters (Feet)	Kilometers (Miles)	DAY Kilometers (Miles)	NIGHT Kilometers (Miles)	Meters (Feet)	Kilometers (Miles)	DAY Kilometers (Miles)	NIGHT Kilometers (Miles)
3306	124 Compressed gas, poisonous, oxidizing, corrosive, n.o.s. (Inhalation Hazard Zone C)	30 m (100 ft)	0.1 km (0.1 mi)	0.5 km (0.3 mi)	300 m (1000 ft)	1.6 km (1.0 mi)	3.2 km (2.0 mi)		
3306	124 Compressed gas, poisonous, oxidizing, corrosive, n.o.s. (Inhalation Hazard Zone D)	30 m (100 ft)	0.1 km (0.1 mi)	0.2 km (0.1 mi)	150 m (500 ft)	0.8 km (0.5 mi)	2.0 km (1.3 mi)		
3306	124 Compressed gas, toxic, oxidizing, corrosive, n.o.s. (Inhalation Hazard Zone A)	100 m (300 ft)	0.5 km (0.3 mi)	2.5 km (1.6 mi)	500 m (1500 ft)	2.9 km (1.8 mi)	9.2 km (5.7 mi)		
3306	124 Compressed gas, toxic, oxidizing, corrosive, n.o.s. (Inhalation Hazard Zone B)	30 m (100 ft)	0.2 km (0.2 mi)	1.0 km (0.7 mi)	400 m (1250 ft)	2.3 km (1.4 mi)	5.1 km (3.2 mi)		
3306	124 Compressed gas, toxic, oxidizing, corrosive, n.o.s. (Inhalation Hazard Zone C)	30 m (100 ft)	0.1 km (0.1 mi)	0.5 km (0.3 mi)	300 m (1000 ft)	1.6 km (1.0 mi)	3.2 km (2.0 mi)		
3306	124 Compressed gas, toxic, oxidizing, corrosive, n.o.s. (Inhalation Hazard Zone D)	30 m (100 ft)	0.1 km (0.1 mi)	0.2 km (0.1 mi)	150 m (500 ft)	0.8 km (0.5 mi)	2.0 km (1.3 mi)		

3307	124	Liquefied gas, poisonous, oxidizing, n.o.s.	100 m (300 ft)	0.5 km (0.3 mi)	2.5 km (1.6 mi)	800 m (2500 ft)	5.0 km (3.1 mi)	11.0+ km (7.0+ mi)
3307	124	Liquefied gas, poisonous, oxidizing, n.o.s. (Inhalation Hazard Zone A)	60 m (200 ft)	0.3 km (0.2 mi)	1.1 km (0.7 mi)	400 m (1250 ft)	2.5 km (1.5 mi)	6.7 km (4.2 mi)
3307	124	Liquefied gas, poisonous, oxidizing, n.o.s. (Inhalation Hazard Zone B)	30 m (100 ft)	0.1 km (0.1 mi)	0.3 km (0.2 mi)	150 m (500 ft)	1.0 km (0.6 mi)	2.9 km (1.8 mi)
3307	124	Liquefied gas, poisonous, oxidizing, n.o.s. (Inhalation Hazard Zone C)	30 m (100 ft)	0.1 km (0.1 mi)	0.2 km (0.1 mi)	150 m (500 ft)	0.8 km (0.5 mi)	2.0 km (1.3 mi)
3307	124	Liquefied gas, toxic, oxidizing, n.o.s. (Inhalation Hazard Zone D)	100 m (300 ft)	0.5 km (0.3 mi)	2.5 km (1.6 mi)	800 m (2500 ft)	5.0 km (3.1 mi)	11.0+ km (7.0+ mi)
3307	124	Liquefied gas, toxic, oxidizing, n.o.s. (Inhalation Hazard Zone A)	60 m (200 ft)	0.3 km (0.2 mi)	1.1 km (0.7 mi)	400 m (1250 ft)	2.5 km (1.5 mi)	6.7 km (4.2 mi)
3307	124	Liquefied gas, toxic, oxidizing, n.o.s. (Inhalation Hazard Zone B)	30 m (100 ft)	0.1 km (0.1 mi)	0.3 km (0.2 mi)	150 m (500 ft)	1.0 km (0.6 mi)	2.9 km (1.8 mi)
3307	124	Liquefied gas, toxic, oxidizing, n.o.s. (Inhalation Hazard Zone C)	30 m (100 ft)	0.1 km (0.1 mi)	0.2 km (0.1 mi)	150 m (500 ft)	0.8 km (0.5 mi)	2.0 km (1.3 mi)

"+" means distance can be larger in certain atmospheric conditions

TABLE 1

TABLE 1 - INITIAL ISOLATION AND PROTECTIVE ACTION DISTANCES

ID No.	Guide NAME OF MATERIAL	SMALL SPILLS (From a small package or small leak from a large package)			LARGE SPILLS (From a large package or from many small packages)		
		First ISOLATE in all Directions Meters (Feet)	Then PROTECT persons Downwind during		First ISOLATE in all Directions Meters (Feet)	Then PROTECT persons Downwind during	
			DAY Kilometers (Miles)	NIGHT Kilometers (Miles)		DAY Kilometers (Miles)	NIGHT Kilometers (Miles)
3308	125 Liquefied gas, poisonous, corrosive, n.o.s.	100 m (300 ft)	0.5 km (0.3 mi)	2.5 km (1.6 mi)	500 m (1500 ft)	2.9 km (1.8 mi)	9.2 km (5.7 mi)
3308	125 Liquefied gas, poisonous, corrosive, n.o.s. (Inhalation Hazard Zone A)	30 m (100 ft)	0.2 km (0.2 mi)	1.0 km (0.7 mi)	400 m (1250 ft)	2.3 km (1.4 mi)	5.1 km (3.2 mi)
3308	125 Liquefied gas, poisonous, corrosive, n.o.s. (Inhalation Hazard Zone B)	30 m (100 ft)	0.1 km (0.1 mi)	0.5 km (0.3 mi)	300 m (1000 ft)	1.6 km (1.0 mi)	3.2 km (2.0 mi)
3308	125 Liquefied gas, poisonous, corrosive, n.o.s. (Inhalation Hazard Zone D)	30 m (100 ft)	0.1 km (0.1 mi)	0.2 km (0.1 mi)	150 m (500 ft)	0.8 km (0.5 mi)	2.0 km (1.3 mi)
3308	125 Liquefied gas, toxic, corrosive, n.o.s.	100 m (300 ft)	0.5 km (0.3 mi)	2.5 km (1.6 mi)	500 m (1500 ft)	2.9 km (1.8 mi)	9.2 km (5.7 mi)
3308	125 Liquefied gas, toxic, corrosive, n.o.s. (Inhalation Hazard Zone B)	30 m (100 ft)	0.2 km (0.2 mi)	1.0 km (0.7 mi)	400 m (1250 ft)	2.3 km (1.4 mi)	5.1 km (3.2 mi)

3308	125	Liquefied gas, toxic, corrosive, n.o.s. (Inhalation Hazard Zone C)	30 m (100 ft)	0.1 km (0.1 mi)	0.5 km (0.3 mi)	300 m (1000 ft)	1.6 km (1.0 mi)	3.2 km (2.0 mi)
3308	125	Liquefied gas, toxic, corrosive, n.o.s. (Inhalation Hazard Zone D)	30 m (100 ft)	0.1 km (0.1 mi)	0.2 km (0.1 mi)	150 m (500 ft)	0.8 km (0.5 mi)	2.0 km (1.3 mi)
3309	119	Liquefied gas, poisonous, flammable, corrosive, n.o.s.						
3309	119	Liquefied gas, poisonous, flammable, corrosive, n.o.s. (Inhalation Hazard Zone A)	100 m (300 ft)	0.5 km (0.3 mi)	2.5 km (1.6 mi)	500 m (1500 ft)	2.9 km (1.8 mi)	9.2 km (5.7 mi)
3309	119	Liquefied gas, poisonous, flammable, corrosive, n.o.s. (Inhalation Hazard Zone B)	30 m (100 ft)	0.2 km (0.2 mi)	1.0 km (0.7 mi)	400 m (1250 ft)	2.3 km (1.4 mi)	5.1 km (3.2 mi)
3309	119	Liquefied gas, poisonous, flammable, corrosive, n.o.s. (Inhalation Hazard Zone C)	30 m (100 ft)	0.1 km (0.1 mi)	0.5 km (0.3 mi)	300 m (1000 ft)	1.6 km (1.0 mi)	3.2 km (2.0 mi)
3309	119	Liquefied gas, poisonous, flammable, corrosive, n.o.s. (Inhalation Hazard Zone D)	30 m (100 ft)	0.1 km (0.1 mi)	0.2 km (0.1 mi)	150 m (500 ft)	0.8 km (0.5 mi)	2.0 km (1.3 mi)
3309	119	Liquefied gas, toxic, flammable, corrosive, n.o.s.						
3309	119	Liquefied gas, toxic, flammable, corrosive, n.o.s. (Inhalation Hazard Zone A)	100 m (300 ft)	0.5 km (0.3 mi)	2.5 km (1.6 mi)	500 m (1500 ft)	2.9 km (1.8 mi)	9.2 km (5.7 mi)
3309	119	Liquefied gas, toxic, flammable, corrosive, n.o.s. (Inhalation Hazard Zone B)	30 m (100 ft)	0.2 km (0.2 mi)	1.0 km (0.7 mi)	400 m (1250 ft)	2.3 km (1.4 mi)	5.1 km (3.2 mi)
3309	119	Liquefied gas, toxic, flammable, corrosive, n.o.s. (Inhalation Hazard Zone C)	30 m (100 ft)	0.1 km (0.1 mi)	0.5 km (0.3 mi)	300 m (1000 ft)	1.6 km (1.0 mi)	3.2 km (2.0 mi)

"+" means distance can be larger in certain atmospheric conditions

TABLE 1

TABLE 1 - INITIAL ISOLATION AND PROTECTIVE ACTION DISTANCES

ID No.	Guide NAME OF MATERIAL	SMALL SPILLS (From a small package or small leak from a large package)				LARGE SPILLS (From a large package or from many small packages)			
		First ISOLATE in all Directions		Then PROTECT persons Downwind during		First ISOLATE in all Directions		Then PROTECT persons Downwind during	
		Meters (Feet)	Kilometers (Miles)	DAY Kilometers (Miles)	NIGHT Kilometers (Miles)	Meters (Feet)	Kilometers (Miles)	DAY Kilometers (Miles)	NIGHT Kilometers (Miles)
3309	119 Liquefied gas, toxic, flammable, corrosive, n.o.s. (Inhalation Hazard Zone D)	30 m (100 ft)	0.1 km (0.1 mi)	0.2 km (0.1 mi)	150 m (500 ft)	0.8 km (0.5 mi)	2.0 km (1.3 mi)		
3310	124 Liquefied gas, poisonous, oxidizing, corrosive, n.o.s.								
3310	124 Liquefied gas, poisonous, oxidizing, corrosive, n.o.s. (Inhalation Hazard Zone A)	100 m (300 ft)	0.5 km (0.3 mi)	2.5 km (1.6 mi)	500 m (1500 ft)	2.9 km (1.8 mi)	9.2 km (5.7 mi)		
3310	124 Liquefied gas, poisonous, oxidizing, corrosive, n.o.s. (Inhalation Hazard Zone B)	30 m (100 ft)	0.2 km (0.2 mi)	1.0 km (0.7 mi)	400 m (1250 ft)	2.3 km (1.4 mi)	5.1 km (3.2 mi)		
3310	124 Liquefied gas, poisonous, oxidizing, corrosive, n.o.s. (Inhalation Hazard Zone C)	30 m (100 ft)	0.1 km (0.1 mi)	0.5 km (0.3 mi)	300 m (1000 ft)	1.6 km (1.0 mi)	3.2 km (2.0 mi)		
3310	124 Liquefied gas, poisonous, oxidizing, corrosive, n.o.s. (Inhalation Hazard Zone D)	30 m (100 ft)	0.1 km (0.1 mi)	0.2 km (0.1 mi)	150 m (500 ft)	0.8 km (0.5 mi)	2.0 km (1.3 mi)		
3310	124 Liquefied gas, toxic, oxidizing, corrosive, n.o.s.								
3310	124 Liquefied gas, toxic, oxidizing, corrosive, n.o.s. (Inhalation Hazard Zone A)	100 m (300 ft)	0.5 km (0.3 mi)	2.5 km (1.6 mi)	500 m (1500 ft)	2.9 km (1.8 mi)	9.2 km (5.7 mi)		

3310	124	Liquefied gas, toxic, oxidizing, corrosive, n.o.s. (Inhalation Hazard Zone B)	30 m (100 ft)	0.2 km (0.2 mi)	1.0 km (0.7 mi)	400 m (1250 ft)	2.3 km (1.4 mi)	5.1 km (3.2 mi)
3310	124	Liquefied gas, toxic, oxidizing, corrosive, n.o.s. (Inhalation Hazard Zone C)	30 m (100 ft)	0.1 km (0.1 mi)	0.5 km (0.3 mi)	300 m (1000 ft)	1.6 km (1.0 mi)	3.2 km (2.0 mi)
3310	124	Liquefied gas, toxic, oxidizing, corrosive, n.o.s. (Inhalation Hazard Zone D)	30 m (100 ft)	0.1 km (0.1 mi)	0.2 km (0.1 mi)	150 m (500 ft)	0.8 km (0.5 mi)	2.0 km (1.3 mi)
3318	125	Ammonia solution, with more than 50% Ammonia	30 m (100 ft)	0.1 km (0.1 mi)	0.2 km (0.1 mi)	150 m (500 ft)	0.8 km (0.5 mi)	2.1 km (1.3 mi)
3355	119	Insecticide gas, poisonous, flammable, n.o.s.						
3355	119	Insecticide gas, poisonous, flammable, n.o.s. (Inhalation Hazard Zone A)	150 m (500 ft)	1.0 km (0.6 mi)	3.8 km (2.4 mi)	1000 m (3000 ft)	5.7 km (3.6 mi)	10.1 km (6.3 mi)
3355	119	Insecticide gas, poisonous, flammable, n.o.s. (Inhalation Hazard Zone B)	30 m (100 ft)	0.1 km (0.1 mi)	0.4 km (0.2 mi)	300 m (1000 ft)	1.3 km (0.8 mi)	3.4 km (2.1 mi)
3355	119	Insecticide gas, poisonous, flammable, n.o.s. (Inhalation Hazard Zone C)	30 m (100 ft)	0.1 km (0.1 mi)	0.3 km (0.2 mi)	150 m (500 ft)	1.0 km (0.6 mi)	2.9 km (1.8 mi)
3355	119	Insecticide gas, poisonous, flammable, n.o.s. (Inhalation Hazard Zone D)	30 m (100 ft)	0.1 km (0.1 mi)	0.2 km (0.1 mi)	150 m (500 ft)	0.8 km (0.5 mi)	2.0 km (1.3 mi)
3355	119	Insecticide gas, toxic, flammable, n.o.s.						
3355	119	Insecticide gas, toxic, flammable, n.o.s. (Inhalation Hazard Zone A)	150 m (500 ft)	1.0 km (0.6 mi)	3.8 km (2.4 mi)	1000 m (3000 ft)	5.7 km (3.6 mi)	10.1 km (6.3 mi)

"+" means distance can be larger in certain atmospheric conditions

TABLE 1

TABLE 1 - INITIAL ISOLATION AND PROTECTIVE ACTION DISTANCES

ID No.	Guide NAME OF MATERIAL	SMALL SPILLS (From a small package or small leak from a large package)				LARGE SPILLS (From a large package or from many small packages)			
		First ISOLATE in all Directions		Then PROTECT persons Downwind during		First ISOLATE in all Directions		Then PROTECT persons Downwind during	
		Meters (Feet)	Kilometers (Miles)	DAY Kilometers (Miles)	NIGHT Kilometers (Miles)	Meters (Feet)	Kilometers (Miles)	DAY Kilometers (Miles)	NIGHT Kilometers (Miles)
3355	119 Insecticide gas, toxic, flammable, n.o.s. (Inhalation Hazard Zone B)	30 m (100 ft)	0.1 km (0.1 mi)	0.4 km (0.2 mi)	300 m (1000 ft)	1.3 km (0.8 mi)	3.4 km (2.1 mi)		
3355	119 Insecticide gas, toxic, flammable, n.o.s. (Inhalation Hazard Zone C)	30 m (100 ft)	0.1 km (0.1 mi)	0.3 km (0.2 mi)	150 m (500 ft)	1.0 km (0.6 mi)	2.9 km (1.8 mi)		
3355	119 Insecticide gas, toxic, flammable, n.o.s. (Inhalation Hazard Zone D)	30 m (100 ft)	0.1 km (0.1 mi)	0.2 km (0.1 mi)	150 m (500 ft)	0.8 km (0.5 mi)	2.0 km (1.3 mi)		
3361	156 Chlorosilanes, poisonous, corrosive, n.o.s. (when spilled in water)	30 m (100 ft)	0.1 km (0.1 mi)	0.2 km (0.1 mi)	60 m (200 ft)	0.5 km (0.3 mi)	1.6 km (1.0 mi)		
3361	156 Chlorosilanes, toxic, corrosive, n.o.s. (when spilled in water)	30 m (100 ft)	0.1 km (0.1 mi)	0.2 km (0.1 mi)	60 m (200 ft)	0.5 km (0.3 mi)	1.6 km (1.0 mi)		
3362	155 Chlorosilanes, poisonous, corrosive, flammable, n.o.s. (when spilled in water)	30 m (100 ft)	0.1 km (0.1 mi)	0.2 km (0.1 mi)	60 m (200 ft)	0.5 km (0.3 mi)	1.6 km (1.0 mi)		
3362	155 Chlorosilanes, toxic, corrosive, flammable, n.o.s. (when spilled in water)	30 m (100 ft)	0.1 km (0.1 mi)	0.2 km (0.1 mi)	60 m (200 ft)	0.5 km (0.3 mi)	1.6 km (1.0 mi)		
3381	151 Poisonous by inhalation liquid, n.o.s. (Inhalation Hazard Zone A)	60 m (200 ft)	0.6 km (0.4 mi)	1.2 km (0.8 mi)	200 m (600 ft)	2.2 km (1.4 mi)	4.2 km (2.6 mi)		
3381	151 Toxic by inhalation liquid, n.o.s. (Inhalation Hazard Zone A)	60 m (200 ft)	0.6 km (0.4 mi)	1.2 km (0.8 mi)	200 m (600 ft)	2.2 km (1.4 mi)	4.2 km (2.6 mi)		

3382	151	Poisonous by inhalation liquid, n.o.s. (Inhalation Hazard Zone B)	30 m (100 ft)	0.2 km (0.1 mi)	0.2 km (0.2 mi)	60 m (200 ft)	0.5 km (0.3 mi)	0.7 km (0.5 mi)
3382	151	Toxic by inhalation liquid, n.o.s. (Inhalation Hazard Zone B)						
3383	131	Poisonous by inhalation liquid, flammable, n.o.s. (Inhalation Hazard Zone A)	60 m (200 ft)	0.5 km (0.3 mi)	1.5 km (0.9 mi)	300 m (1000 ft)	3.1 km (2.0 mi)	5.8 km (3.6 mi)
3383	131	Toxic by inhalation liquid, flammable, n.o.s. (Inhalation Hazard Zone A)						
3384	131	Poisonous by inhalation liquid, flammable, n.o.s. (Inhalation Hazard Zone B)	30 m (100 ft)	0.2 km (0.1 mi)	0.3 km (0.2 mi)	60 m (200 ft)	0.6 km (0.4 mi)	1.0 km (0.6 mi)
3384	131	Toxic by inhalation liquid, flammable, n.o.s. (Inhalation Hazard Zone B)						
3385	139	Poisonous by inhalation liquid, water-reactive, n.o.s. (Inhalation Hazard Zone A)	60 m (200 ft)	0.6 km (0.4 mi)	1.2 km (0.8 mi)	200 m (600 ft)	2.2 km (1.4 mi)	4.2 km (2.6 mi)
3385	139	Toxic by inhalation liquid, water-reactive, n.o.s. (Inhalation Hazard Zone A)						
3386	139	Poisonous by inhalation liquid, water-reactive, n.o.s. (Inhalation Hazard Zone B)	30 m (100 ft)	0.2 km (0.1 mi)	0.2 km (0.2 mi)	60 m (200 ft)	0.5 km (0.3 mi)	0.7 km (0.5 mi)
3386	139	Toxic by inhalation liquid, water-reactive, n.o.s. (Inhalation Hazard Zone B)						

"+" means distance can be larger in certain atmospheric conditions

TABLE 1

TABLE 1 - INITIAL ISOLATION AND PROTECTIVE ACTION DISTANCES

ID No.	Guide	NAME OF MATERIAL	SMALL SPILLS (From a small package or small leak from a large package)				LARGE SPILLS (From a large package or from many small packages)			
			First ISOLATE in all Directions		Then PROTECT persons Downwind during		First ISOLATE in all Directions		Then PROTECT persons Downwind during	
			Meters (Feet)	Kilometers (Miles)	DAY Kilometers (Miles)	NIGHT Kilometers (Miles)	Meters (Feet)	DAY Kilometers (Miles)	NIGHT Kilometers (Miles)	
3387	142	Poisonous by inhalation liquid, oxidizing, n.o.s. (Inhalation Hazard Zone A)	60 m (200 ft)	0.6 km (0.4 mi)	1.2 km (0.8 mi)	200 m (600 ft)	2.2 km (1.4 mi)	4.2 km (2.6 mi)		
3387	142	Toxic by inhalation liquid, oxidizing, n.o.s. (Inhalation Hazard Zone A)	60 m (200 ft)	0.6 km (0.4 mi)	1.2 km (0.8 mi)	200 m (600 ft)	2.2 km (1.4 mi)	4.2 km (2.6 mi)		
3388	142	Poisonous by inhalation liquid, oxidizing, n.o.s. (Inhalation Hazard Zone B)	30 m (100 ft)	0.1 km (0.1 mi)	0.1 km (0.1 mi)	30 m (100 ft)	0.3 km (0.2 mi)	0.4 km (0.3 mi)		
3388	142	Toxic by inhalation liquid, oxidizing, n.o.s. (Inhalation Hazard Zone B)	30 m (100 ft)	0.1 km (0.1 mi)	0.1 km (0.1 mi)	30 m (100 ft)	0.3 km (0.2 mi)	0.4 km (0.3 mi)		
3389	154	Poisonous by inhalation liquid, corrosive, n.o.s. (Inhalation Hazard Zone A)	100 m (300 ft)	0.3 km (0.2 mi)	0.8 km (0.5 mi)	400 m (1250 ft)	1.4 km (0.9 mi)	3.3 km (2.1 mi)		
3389	154	Toxic by inhalation liquid, corrosive, n.o.s. (Inhalation Hazard Zone A)	100 m (300 ft)	0.3 km (0.2 mi)	0.8 km (0.5 mi)	400 m (1250 ft)	1.4 km (0.9 mi)	3.3 km (2.1 mi)		
3390	154	Poisonous by inhalation liquid, corrosive, n.o.s. (Inhalation Hazard Zone B)	30 m (100 ft)	0.2 km (0.1 mi)	0.2 km (0.1 mi)	30 m (100 ft)	0.4 km (0.3 mi)	0.6 km (0.4 mi)		
3390	154	Toxic by inhalation liquid, corrosive, n.o.s. (Inhalation Hazard Zone B)	30 m (100 ft)	0.2 km (0.1 mi)	0.2 km (0.1 mi)	30 m (100 ft)	0.4 km (0.3 mi)	0.6 km (0.4 mi)		

3456	157	Nitrosylsulfuric acid, solid (when spilled in water)	30 m (100 ft)	0.1 km (0.1 mi)	0.3 km (0.2 mi)	300 m (1000 ft)	1.0 km (0.6 mi)	2.9 km (1.8 mi)
3456	157	Nitrosylsulfuric acid, solid (when spilled in water)						
3488	131	Poisonous by inhalation liquid, flammable, corrosive, n.o.s. (Inhalation Hazard Zone A)	100 m (300 ft)	0.9 km (0.6 mi)	2.0 km (1.2 mi)	400 m (1250 ft)	4.8 km (3.0 mi)	7.5 km (4.7 mi)
3488	131	Toxic by inhalation liquid, flammable, corrosive, n.o.s. (Inhalation Hazard Zone A)						
3489	131	Poisonous by inhalation liquid, flammable, corrosive, n.o.s. (Inhalation Hazard Zone B)	30 m (100 ft)	0.2 km (0.1 mi)	0.3 km (0.2 mi)	60 m (200 ft)	0.6 km (0.4 mi)	1.0 km (0.6 mi)
3489	131	Toxic by inhalation liquid, flammable, corrosive, n.o.s. (Inhalation Hazard Zone B)						
3490	155	Poisonous by inhalation liquid, water-reactive, flammable, n.o.s. (Inhalation Hazard Zone A)	60 m (200 ft)	0.5 km (0.3 mi)	1.5 km (0.9 mi)	300 m (1000 ft)	3.1 km (2.0 mi)	5.8 km (3.6 mi)
3490	155	Toxic by inhalation liquid, water- reactive, flammable, n.o.s. (Inhalation Hazard Zone A)						
3491	155	Poisonous by inhalation liquid, water-reactive, flammable, n.o.s. (Inhalation Hazard Zone B)	30 m (100 ft)	0.2 km (0.1 mi)	0.3 km (0.2 mi)	60 m (200 ft)	0.6 km (0.4 mi)	1.0 km (0.6 mi)
3491	155	Toxic by inhalation liquid, water- reactive, flammable, n.o.s. (Inhalation Hazard Zone B)						

"+" means distance can be larger in certain atmospheric conditions

TABLE 1

TABLE 1 - INITIAL ISOLATION AND PROTECTIVE ACTION DISTANCES

ID No.	Guide	NAME OF MATERIAL	SMALL SPILLS (From a small package or small leak from a large package)				LARGE SPILLS (From a large package or from many small packages)			
			First ISOLATE in all Directions		Then PROTECT persons Downwind during		First ISOLATE in all Directions		Then PROTECT persons Downwind during	
			Meters (Feet)	Kilometers (Miles)	DAY Kilometers (Miles)	NIGHT Kilometers (Miles)	Meters (Feet)	DAY Kilometers (Miles)	NIGHT Kilometers (Miles)	
3492	131	Poisonous by inhalation liquid, corrosive, flammable, n.o.s. (Inhalation Hazard Zone A)	100 m (300 ft)	0.9 km (0.6 mi)	2.0 km (1.2 mi)	400 m (1250 ft)	4.8 km (3.0 mi)	7.5 km (4.7 mi)		
3492	131	Toxic by inhalation liquid, corrosive, flammable, n.o.s. (Inhalation Hazard Zone A)	100 m (300 ft)	0.9 km (0.6 mi)	2.0 km (1.2 mi)	400 m (1250 ft)	4.8 km (3.0 mi)	7.5 km (4.7 mi)		
3493	131	Poisonous by inhalation liquid, corrosive, flammable, n.o.s. (Inhalation Hazard Zone B)	30 m (100 ft)	0.2 km (0.1 mi)	0.3 km (0.2 mi)	60 m (200 ft)	0.6 km (0.4 mi)	1.0 km (0.6 mi)		
3493	131	Toxic by inhalation liquid, corrosive, flammable, n.o.s. (Inhalation Hazard Zone B)	30 m (100 ft)	0.2 km (0.1 mi)	0.3 km (0.2 mi)	60 m (200 ft)	0.6 km (0.4 mi)	1.0 km (0.6 mi)		
3494	131	Petroleum sour crude oil, flammable, poisonous	30 m (100 ft)	0.2 km (0.1 mi)	0.2 km (0.2 mi)	60 m (200 ft)	0.5 km (0.3 mi)	0.7 km (0.5 mi)		
3494	131	Petroleum sour crude oil, flammable, toxic	30 m (100 ft)	0.2 km (0.1 mi)	0.2 km (0.2 mi)	60 m (200 ft)	0.5 km (0.3 mi)	0.7 km (0.5 mi)		
3507	166	Uranium hexafluoride, radioactive material, excepted package, less than 0.1 kg per package, non-fissile or fissile-excepted (when spilled in water)	30 m (100 ft)	0.1 km (0.1 mi)	0.1 km (0.1 mi)	30 m (100 ft)	0.1 km (0.1 mi)	0.1 km (0.1 mi)		

3512	173	Adsorbed gas, poisonous, n.o.s.	30 m (100 ft)	0.1 km (0.1 mi)	0.1 km (0.1 mi)	30 m (100 ft)	0.1 km (0.1 mi)	0.2 km (0.2 mi)
3512	173	Adsorbed gas, poisonous, n.o.s. (Inhalation hazard zone A)	30 m (100 ft)	0.1 km (0.1 mi)	0.1 km (0.1 mi)	30 m (100 ft)	0.1 km (0.1 mi)	0.2 km (0.2 mi)
3512	173	Adsorbed gas, poisonous, n.o.s. (Inhalation hazard zone B)	30 m (100 ft)	0.1 km (0.1 mi)	0.1 km (0.1 mi)	30 m (100 ft)	0.1 km (0.1 mi)	0.2 km (0.2 mi)
3512	173	Adsorbed gas, poisonous, n.o.s. (Inhalation hazard zone C)	30 m (100 ft)	0.1 km (0.1 mi)	0.1 km (0.1 mi)	30 m (100 ft)	0.1 km (0.1 mi)	0.2 km (0.2 mi)
3512	173	Adsorbed gas, poisonous, n.o.s. (Inhalation hazard zone D)	30 m (100 ft)	0.1 km (0.1 mi)	0.1 km (0.1 mi)	30 m (100 ft)	0.1 km (0.1 mi)	0.2 km (0.2 mi)
3512	173	Adsorbed gas, toxic, n.o.s. (Inhalation hazard zone A)	30 m (100 ft)	0.1 km (0.1 mi)	0.1 km (0.1 mi)	30 m (100 ft)	0.1 km (0.1 mi)	0.2 km (0.2 mi)
3512	173	Adsorbed gas, toxic, n.o.s. (Inhalation hazard zone B)	30 m (100 ft)	0.1 km (0.1 mi)	0.1 km (0.1 mi)	30 m (100 ft)	0.1 km (0.1 mi)	0.2 km (0.2 mi)
3512	173	Adsorbed gas, toxic, n.o.s. (Inhalation hazard zone C)	30 m (100 ft)	0.1 km (0.1 mi)	0.1 km (0.1 mi)	30 m (100 ft)	0.1 km (0.1 mi)	0.2 km (0.2 mi)
3512	173	Adsorbed gas, toxic, n.o.s. (Inhalation hazard zone D)	30 m (100 ft)	0.1 km (0.1 mi)	0.1 km (0.1 mi)	30 m (100 ft)	0.1 km (0.1 mi)	0.2 km (0.2 mi)
3514	173	Adsorbed gas, poisonous, flammable, n.o.s.	30 m (100 ft)	0.1 km (0.1 mi)	0.1 km (0.1 mi)	30 m (100 ft)	0.1 km (0.1 mi)	0.2 km (0.2 mi)
3514	173	Adsorbed gas, poisonous, flammable, n.o.s. (Inhalation hazard zone A)	30 m (100 ft)	0.1 km (0.1 mi)	0.1 km (0.1 mi)	30 m (100 ft)	0.1 km (0.1 mi)	0.2 km (0.2 mi)

"+" means distance can be larger in certain atmospheric conditions

TABLE 1

TABLE 1 - INITIAL ISOLATION AND PROTECTIVE ACTION DISTANCES

ID No.	Guide	NAME OF MATERIAL	SMALL SPILLS (From a small package or small leak from a large package)			LARGE SPILLS (From a large package or from many small packages)		
			First ISOLATE in all Directions Meters (Feet)	Then PROTECT persons Downwind during		First ISOLATE in all Directions Meters (Feet)	Then PROTECT persons Downwind during	
				DAY Kilometers (Miles)	NIGHT Kilometers (Miles)		DAY Kilometers (Miles)	NIGHT Kilometers (Miles)
3514	173	Adsorbed gas, poisonous, flammable, n.o.s. (Inhalation hazard zone B)						
3514	173	Adsorbed gas, poisonous, flammable, n.o.s. (Inhalation hazard zone C)	30 m (100 ft)	0.1 km (0.1 mi)	0.1 km (0.1 mi)	30 m (100 ft)	0.1 km (0.1 mi)	0.1 km (0.1 mi)
3514	173	Adsorbed gas, poisonous, flammable, n.o.s. (Inhalation hazard zone D)						
3514	173	Adsorbed gas, toxic, flammable, n.o.s.						
3514	173	Adsorbed gas, toxic, flammable, n.o.s. (Inhalation hazard zone A)	30 m (100 ft)	0.1 km (0.1 mi)	0.1 km (0.1 mi)	30 m (100 ft)	0.1 km (0.1 mi)	0.2 km (0.2 mi)
3514	173	Adsorbed gas, toxic, flammable, n.o.s. (Inhalation hazard zone B)						
3514	173	Adsorbed gas, toxic, flammable, n.o.s. (Inhalation hazard zone C)	30 m (100 ft)	0.1 km (0.1 mi)	0.1 km (0.1 mi)	30 m (100 ft)	0.1 km (0.1 mi)	0.1 km (0.1 mi)
3514	173	Adsorbed gas, toxic, flammable, n.o.s. (Inhalation hazard zone D)						

3515	173	Adsorbed gas, poisonous, oxidizing, n.o.s.	30 m (100 ft)	0.1 km (0.1 mi)	30 m (100 ft)	0.1 km (0.1 mi)	0.2 km (0.2 mi)
3515	173	Adsorbed gas, poisonous, oxidizing, n.o.s. (Inhalation hazard zone A)	30 m (100 ft)	0.1 km (0.1 mi)	30 m (100 ft)	0.1 km (0.1 mi)	0.2 km (0.2 mi)
3515	173	Adsorbed gas, poisonous, oxidizing, n.o.s. (Inhalation hazard zone B)	30 m (100 ft)	0.1 km (0.1 mi)	30 m (100 ft)	0.1 km (0.1 mi)	0.2 km (0.2 mi)
3515	173	Adsorbed gas, poisonous, oxidizing, n.o.s. (Inhalation hazard zone C)	30 m (100 ft)	0.1 km (0.1 mi)	30 m (100 ft)	0.1 km (0.1 mi)	0.2 km (0.2 mi)
3515	173	Adsorbed gas, poisonous, oxidizing, n.o.s. (Inhalation hazard zone D)	30 m (100 ft)	0.1 km (0.1 mi)	30 m (100 ft)	0.1 km (0.1 mi)	0.2 km (0.2 mi)
3515	173	Adsorbed gas, toxic, oxidizing, n.o.s.	30 m (100 ft)	0.1 km (0.1 mi)	30 m (100 ft)	0.1 km (0.1 mi)	0.2 km (0.2 mi)
3515	173	Adsorbed gas, toxic, oxidizing, n.o.s. (Inhalation hazard zone A)	30 m (100 ft)	0.1 km (0.1 mi)	30 m (100 ft)	0.1 km (0.1 mi)	0.2 km (0.2 mi)
3515	173	Adsorbed gas, toxic, oxidizing, n.o.s. (Inhalation hazard zone B)	30 m (100 ft)	0.1 km (0.1 mi)	30 m (100 ft)	0.1 km (0.1 mi)	0.2 km (0.2 mi)
3515	173	Adsorbed gas, toxic, oxidizing, n.o.s. (Inhalation hazard zone C)	30 m (100 ft)	0.1 km (0.1 mi)	30 m (100 ft)	0.1 km (0.1 mi)	0.2 km (0.2 mi)
3515	173	Adsorbed gas, toxic, oxidizing, n.o.s. (Inhalation hazard zone D)	30 m (100 ft)	0.1 km (0.1 mi)	30 m (100 ft)	0.1 km (0.1 mi)	0.2 km (0.2 mi)
3516	173	Adsorbed gas, poisonous, corrosive, n.o.s.	30 m (100 ft)	0.1 km (0.1 mi)	30 m (100 ft)	0.1 km (0.1 mi)	0.2 km (0.2 mi)
3516	173	Adsorbed gas, poisonous, corrosive, n.o.s. (Inhalation hazard zone A)	30 m (100 ft)	0.1 km (0.1 mi)	30 m (100 ft)	0.1 km (0.1 mi)	0.2 km (0.2 mi)

"+" means distance can be larger in certain atmospheric conditions

TABLE 1

TABLE 1 - INITIAL ISOLATION AND PROTECTIVE ACTION DISTANCES

		SMALL SPILLS (From a small package or small leak from a large package)			LARGE SPILLS (From a large package or from many small packages)		
ID No.	Guide NAME OF MATERIAL	First ISOLATE	Then PROTECT		First ISOLATE	Then PROTECT	
		Meters (Feet) in all Directions	persons Downwind during DAY	NIGHT	Meters (Feet) in all Directions	persons Downwind during DAY	NIGHT
			Kilometers (Miles)	Kilometers (Miles)		Kilometers (Miles)	Kilometers (Miles)
3516	173 Adsorbed gas, poisonous, corrosive, n.o.s. (inhalation hazard zone B)	30 m (100 ft)	0.1 km (0.1 mi)	0.1 km (0.1 mi)	30 m (100 ft)	0.1 km (0.1 mi)	0.1 km (0.1 mi)
3516	173 Adsorbed gas, poisonous, corrosive, n.o.s. (inhalation hazard zone C)	30 m (100 ft)	0.1 km (0.1 mi)	0.1 km (0.1 mi)	30 m (100 ft)	0.1 km (0.1 mi)	0.1 km (0.1 mi)
3516	173 Adsorbed gas, poisonous, corrosive, n.o.s. (inhalation hazard zone D)	30 m (100 ft)	0.1 km (0.1 mi)	0.1 km (0.1 mi)	30 m (100 ft)	0.1 km (0.1 mi)	0.1 km (0.1 mi)
3516	173 Adsorbed gas, toxic, corrosive, n.o.s.	30 m (100 ft)	0.1 km (0.1 mi)	0.1 km (0.1 mi)	30 m (100 ft)	0.1 km (0.1 mi)	0.2 km (0.2 mi)
3516	173 Adsorbed gas, toxic, corrosive, n.o.s. (inhalation hazard zone A)	30 m (100 ft)	0.1 km (0.1 mi)	0.1 km (0.1 mi)	30 m (100 ft)	0.1 km (0.1 mi)	0.2 km (0.2 mi)
3516	173 Adsorbed gas, toxic, corrosive, n.o.s. (inhalation hazard zone B)	30 m (100 ft)	0.1 km (0.1 mi)	0.1 km (0.1 mi)	30 m (100 ft)	0.1 km (0.1 mi)	0.1 km (0.1 mi)
3516	173 Adsorbed gas, toxic, corrosive, n.o.s. (inhalation hazard zone C)	30 m (100 ft)	0.1 km (0.1 mi)	0.1 km (0.1 mi)	30 m (100 ft)	0.1 km (0.1 mi)	0.1 km (0.1 mi)
3516	173 Adsorbed gas, toxic, corrosive, n.o.s. (inhalation hazard zone D)	30 m (100 ft)	0.1 km (0.1 mi)	0.1 km (0.1 mi)	30 m (100 ft)	0.1 km (0.1 mi)	0.2 km (0.2 mi)
3517	173 Adsorbed gas, poisonous, flammable, corrosive, n.o.s.	30 m (100 ft)	0.1 km (0.1 mi)	0.1 km (0.1 mi)	30 m (100 ft)	0.1 km (0.1 mi)	0.2 km (0.2 mi)
3517	173 Adsorbed gas, poisonous, flammable, corrosive, n.o.s. (inhalation hazard zone A)	30 m (100 ft)	0.1 km (0.1 mi)	0.1 km (0.1 mi)	30 m (100 ft)	0.1 km (0.1 mi)	0.2 km (0.2 mi)

3517	173	Adsorbed gas, poisonous, flammable, corrosive, n.o.s. (Inhalation hazard zone B)	30 m (100 ft)	0.1 km (0.1 mi)	0.1 km (0.1 mi)	30 m (100 ft)	0.1 km (0.1 mi)	0.1 km (0.1 mi)	0.1 km (0.1 mi)
3517	173	Adsorbed gas, poisonous, flammable, corrosive, n.o.s. (Inhalation hazard zone C)	30 m (100 ft)	0.1 km (0.1 mi)	0.1 km (0.1 mi)	30 m (100 ft)	0.1 km (0.1 mi)	0.1 km (0.1 mi)	0.1 km (0.1 mi)
3517	173	Adsorbed gas, poisonous, flammable, corrosive, n.o.s. (Inhalation hazard zone D)	30 m (100 ft)	0.1 km (0.1 mi)	0.1 km (0.1 mi)	30 m (100 ft)	0.1 km (0.1 mi)	0.1 km (0.1 mi)	0.1 km (0.1 mi)
3517	173	Adsorbed gas, toxic, flammable, corrosive, n.o.s.	30 m (100 ft)	0.1 km (0.1 mi)	0.1 km (0.1 mi)	30 m (100 ft)	0.1 km (0.1 mi)	0.1 km (0.1 mi)	0.2 km (0.2 mi)
3517	173	Adsorbed gas, toxic, flammable, corrosive, n.o.s. (Inhalation hazard zone A)	30 m (100 ft)	0.1 km (0.1 mi)	0.1 km (0.1 mi)	30 m (100 ft)	0.1 km (0.1 mi)	0.1 km (0.1 mi)	0.1 km (0.1 mi)
3517	173	Adsorbed gas, toxic, flammable, corrosive, n.o.s. (Inhalation hazard zone B)	30 m (100 ft)	0.1 km (0.1 mi)	0.1 km (0.1 mi)	30 m (100 ft)	0.1 km (0.1 mi)	0.1 km (0.1 mi)	0.1 km (0.1 mi)
3517	173	Adsorbed gas, toxic, flammable, corrosive, n.o.s. (Inhalation hazard zone C)	30 m (100 ft)	0.1 km (0.1 mi)	0.1 km (0.1 mi)	30 m (100 ft)	0.1 km (0.1 mi)	0.1 km (0.1 mi)	0.1 km (0.1 mi)
3517	173	Adsorbed gas, toxic, flammable, corrosive, n.o.s. (Inhalation hazard zone D)	30 m (100 ft)	0.1 km (0.1 mi)	0.1 km (0.1 mi)	30 m (100 ft)	0.1 km (0.1 mi)	0.1 km (0.1 mi)	0.2 km (0.2 mi)
3518	173	Adsorbed gas, poisonous, oxidizing, corrosive, n.o.s.	30 m (100 ft)	0.1 km (0.1 mi)	0.1 km (0.1 mi)	30 m (100 ft)	0.1 km (0.1 mi)	0.1 km (0.1 mi)	0.2 km (0.2 mi)
3518	173	Adsorbed gas, poisonous, oxidizing, corrosive, n.o.s. (Inhalation hazard zone A)	30 m (100 ft)	0.1 km (0.1 mi)	0.1 km (0.1 mi)	30 m (100 ft)	0.1 km (0.1 mi)	0.1 km (0.1 mi)	0.2 km (0.2 mi)

"+" means distance can be larger in certain atmospheric conditions

TABLE 1

TABLE 1 - INITIAL ISOLATION AND PROTECTIVE ACTION DISTANCES

		SMALL SPILLS (From a small package or small leak from a large package)			LARGE SPILLS (From a large package or from many small packages)		
ID No.	Guide NAME OF MATERIAL	First ISOLATE in all Directions Meters (Feet)	Then PROTECT persons Downwind during		First ISOLATE in all Directions Meters (Feet)	Then PROTECT persons Downwind during	
			DAY Kilometers (Miles)	NIGHT Kilometers (Miles)		DAY Kilometers (Miles)	NIGHT Kilometers (Miles)
3518	173 Adsorbed gas, poisonous, oxidizing, corrosive, n.o.s. (Inhalation hazard zone B)						
3518	173 Adsorbed gas, poisonous, oxidizing, corrosive, n.o.s. (Inhalation hazard zone C)	30 m (100 ft)	0.1 km (0.1 mi)	0.1 km (0.1 mi)	30 m (100 ft)	0.1 km (0.1 mi)	0.1 km (0.1 mi)
3518	173 Adsorbed gas, poisonous, oxidizing, corrosive, n.o.s. (Inhalation hazard zone D)						
3518	173 Adsorbed gas, toxic, oxidizing, corrosive, n.o.s.						
3518	173 Adsorbed gas, toxic, oxidizing, corrosive, n.o.s. (Inhalation hazard zone A)	30 m (100 ft)	0.1 km (0.1 mi)	0.1 km (0.1 mi)	30 m (100 ft)	0.1 km (0.1 mi)	0.2 km (0.2 mi)
3518	173 Adsorbed gas, toxic, oxidizing, corrosive, n.o.s. (Inhalation hazard zone B)						
3518	173 Adsorbed gas, toxic, oxidizing, corrosive, n.o.s. (Inhalation hazard zone C)	30 m (100 ft)	0.1 km (0.1 mi)	0.1 km (0.1 mi)	30 m (100 ft)	0.1 km (0.1 mi)	0.1 km (0.1 mi)
3518	173 Adsorbed gas, toxic, oxidizing, corrosive, n.o.s. (Inhalation hazard zone D)						
3519	173 Boron trifluoride, adsorbed	30 m (100 ft)	0.1 km (0.1 mi)	0.1 km (0.1 mi)	30 m (100 ft)	0.1 km (0.1 mi)	0.1 km (0.1 mi)
3520	173 Chlorine, adsorbed	30 m (100 ft)	0.1 km (0.1 mi)	0.1 km (0.1 mi)	30 m (100 ft)	0.1 km (0.1 mi)	0.1 km (0.1 mi)

3521	173	Silicon tetrafluoride, adsorbed	30 m (100 ft)	0.1 km (0.1 mi)	0.1 km (0.1 mi)	30 m (100 ft)	0.1 km (0.1 mi)	0.1 km (0.1 mi)	0.1 km (0.1 mi)
3522	173	Arsine, adsorbed	30 m (100 ft)	0.1 km (0.1 mi)	0.1 km (0.1 mi)	30 m (100 ft)	0.1 km (0.1 mi)	0.1 km (0.1 mi)	0.2 km (0.2 mi)
3523	173	Germane, adsorbed	30 m (100 ft)	0.1 km (0.1 mi)	0.1 km (0.1 mi)	30 m (100 ft)	0.1 km (0.1 mi)	0.1 km (0.1 mi)	0.2 km (0.2 mi)
3524	173	Phosphorus pentafluoride, adsorbed	30 m (100 ft)	0.1 km (0.1 mi)	0.1 km (0.1 mi)	30 m (100 ft)	0.1 km (0.1 mi)	0.1 km (0.1 mi)	0.1 km (0.1 mi)
3525	173	Phosphine, adsorbed	30 m (100 ft)	0.1 km (0.1 mi)	0.1 km (0.1 mi)	30 m (100 ft)	0.1 km (0.1 mi)	0.1 km (0.1 mi)	0.1 km (0.1 mi)
3526	173	Hydrogen selenide, adsorbed	30 m (100 ft)	0.1 km (0.1 mi)	0.1 km (0.1 mi)	30 m (100 ft)	0.1 km (0.1 mi)	0.1 km (0.1 mi)	0.4 km (0.3 mi)
3539	123	Articles containing toxic gas, n.o.s.	30 m (100 ft)	0.1 km (0.1 mi)	0.1 km (0.1 mi)	30 m (100 ft)	0.1 km (0.1 mi)	0.1 km (0.1 mi)	0.4 km (0.3 mi)
9191	143	Chlorine dioxide, hydrate, frozen (when spilled in water)	30 m (100 ft)	0.1 km (0.1 mi)	0.1 km (0.1 mi)	30 m (100 ft)	0.2 km (0.1 mi)	0.2 km (0.1 mi)	0.5 km (0.3 mi)
9202	168	Carbon monoxide, refrigerated liquid (cryogenic liquid)	30 m (100 ft)	0.1 km (0.1 mi)	0.2 km (0.1 mi)	200 m (600 ft)	1.2 km (0.7 mi)	4.3 km (2.7 mi)	
9206	137	Methyl phosphonic dichloride	30 m (100 ft)	0.1 km (0.1 mi)	0.2 km (0.1 mi)	30 m (100 ft)	0.4 km (0.3 mi)	0.6 km (0.4 mi)	
9263	156	Chloropivaloyl chloride	30 m (100 ft)	0.1 km (0.1 mi)	0.1 km (0.1 mi)	30 m (100 ft)	0.2 km (0.2 mi)	0.3 km (0.2 mi)	
9264	151	3,5-Dichloro-2,4,6-trifluoropyridine	30 m (100 ft)	0.1 km (0.1 mi)	0.1 km (0.1 mi)	30 m (100 ft)	0.2 km (0.2 mi)	0.3 km (0.2 mi)	
9269	132	Trimethoxysilane	30 m (100 ft)	0.2 km (0.2 mi)	0.6 km (0.4 mi)	100 m (300 ft)	1.3 km (0.8 mi)	2.3 km (1.5 mi)	

See Next Page for Table of Water-Reactive Materials Which Produce Toxic Gases

"+" means distance can be larger in certain atmospheric conditions

TABLE 1

HOW TO USE TABLE 2 – WATER-REACTIVE MATERIALS THAT PRODUCE TOXIC GASES

Table 2 lists materials that produce large amounts of Toxic Inhalation Hazard (TIH) (PIH in the US) gases when spilled in water, and identifies the TIH gases produced.

The materials are listed by order of ID number.

These Water-Reactive materials are easily identified in Table 1 as their name is immediately followed by **(when spilled in water)**.

Note 1: The TIH gases indicated in Table 2 are for information purposes only. In Table 1, the initial isolation and protective action distances have already taken into consideration the TIH gases produced.

For example: Table 2 indicates that UN1689 sodium cyanide, when spilled in water, will generate hydrogen cyanide gas (HCN). In Table 1, you must refer to the distances for sodium cyanide and not the distances for hydrogen cyanide gas.

Note 2: Some Water-Reactive materials are also TIH materials themselves (e.g., UN1746 (Bromine trifluoride), UN1836 (Thionyl chloride)). In these instances, two entries are provided in Table 1 for land-based and water-based spills. If a water-reactive material only has one entry in Table 1 for **(when spilled in water)**, and the product is **NOT** spilled in water, Tables 1 and 2 do **NOT** apply. Refer only to the appropriate orange-bordered guide.

Note 3: Materials classified as a Division 4.3 are substances that, on contact with water, are liable to become spontaneously **FLAMMABLE** or give off **FLAMMABLE** or sometimes **TOXIC** gases in dangerous quantities. For the purpose of this table, water-reactive materials are materials that generate substantial quantities of **TOXIC** gases rapidly after a spill into water; therefore, a material classified as a Division 4.3 will not always be included in Table 2.

TABLE 2 - WATER-REACTIVE MATERIALS WHICH PRODUCE TOXIC GASES

**Materials Which Produce Large Amounts of Toxic-by-Inhalation (TIH)
(PIH in the US) Gas(es) When Spilled in Water**

ID No.	Guide No.	Name of Material	TIH Gas(es) Produced
1162	155	Dimethyldichlorosilane	HCl
1183	139	Ethyldichlorosilane	HCl
1196	155	Ethyltrichlorosilane	HCl
1242	139	Methyldichlorosilane	HCl
1250	155	Methyltrichlorosilane	HCl
1295	139	Trichlorosilane	HCl
1298	155	Trimethylchlorosilane	HCl
1305	155P	Vinyltrichlorosilane	HCl
1305	155P	Vinyltrichlorosilane, stabilized	HCl
1340	139	Phosphorus pentasulfide, free from yellow and white Phosphorus	H ₂ S
1340	139	Phosphorus pentasulphide, free from yellow and white Phosphorus	H ₂ S
1360	139	Calcium phosphide	PH ₃
1384	135	Sodium dithionite	H ₂ S SO ₂
1384	135	Sodium hydrosulfite	H ₂ S SO ₂
1384	135	Sodium hydrosulphite	H ₂ S SO ₂
1390	139	Alkali metal amides	NH ₃
1397	139	Aluminum phosphide	PH ₃
1419	139	Magnesium aluminum phosphide	PH ₃
1432	139	Sodium phosphide	PH ₃
1541	155	Acetone cyanohydrin, stabilized	HCN
1680	157	Potassium cyanide, solid	HCN
1689	157	Sodium cyanide, solid	HCN

Chemical Symbols for TIH (PIH in the US) Gases:

Br ₂	Bromine	HF	Hydrogen fluoride	NO ₂	Nitrogen dioxide
Cl ₂	Chlorine	HI	Hydrogen iodide	PH ₃	Phosphine
HBr	Hydrogen bromide	H ₂ S	Hydrogen sulfide	SO ₂	Sulfur dioxide
HCl	Hydrogen chloride	H ₂ S	Hydrogen sulphide	SO ₂	Sulphur dioxide
HCN	Hydrogen cyanide	NH ₃	Ammonia		

TABLE 2

TABLE2 - WATER-REACTIVE MATERIALS WHICH PRODUCE TOXIC GASES

**Materials Which Produce Large Amounts of Toxic-by-Inhalation (TIH)
(PIH in the US) Gas(es) When Spilled in Water**

ID No.	Guide No.	Name of Material	TIH Gas(es) Produced
1716	156	Acetyl bromide	HBr
1717	155	Acetyl chloride	HCl
1724	155	Allyltrichlorosilane, stabilized	HCl
1725	137	Aluminum bromide, anhydrous	HBr
1726	137	Aluminum chloride, anhydrous	HCl
1728	155	Amyltrichlorosilane	HCl
1732	157	Antimony pentafluoride	HF
1741	125	Boron trichloride	HCl
1745	144	Bromine pentafluoride	HF Br ₂
1746	144	Bromine trifluoride	HF Br ₂
1747	155	Butyltrichlorosilane	HCl
1752	156	Chloroacetyl chloride	HCl
1753	156	Chlorophenyltrichlorosilane	HCl
1754	137	Chlorosulfonic acid (with or without sulfur trioxide)	HCl
1754	137	Chlorosulphonic acid (with or without sulphur trioxide)	HCl
1758	137	Chromium oxychloride	HCl
1762	156	Cyclohexenyltrichlorosilane	HCl
1763	156	Cyclohexyltrichlorosilane	HCl
1765	156	Dichloroacetyl chloride	HCl
1766	156	Dichlorophenyltrichlorosilane	HCl
1767	155	Diethyldichlorosilane	HCl
1769	156	Dipenyldichlorosilane	HCl
1771	156	Dodecyltrichlorosilane	HCl

Chemical Symbols for TIH (PIH in the US) Gases:

Br ₂	Bromine	HF	Hydrogen fluoride	NO ₂	Nitrogen dioxide
Cl ₂	Chlorine	HI	Hydrogen iodide	PH ₃	Phosphine
HBr	Hydrogen bromide	H ₂ S	Hydrogen sulfide	SO ₂	Sulfur dioxide
HCl	Hydrogen chloride	H ₂ S	Hydrogen sulphide	SO ₂	Sulphur dioxide
HCN	Hydrogen cyanide	NH ₃	Ammonia		

TABLE 2 - WATER-REACTIVE MATERIALS WHICH PRODUCE TOXIC GASES

**Materials Which Produce Large Amounts of Toxic-by-Inhalation (TIH)
(PIH in the US) Gas(es) When Spilled in Water**

ID No.	Guide No.	Name of Material	TIH Gas(es) Produced
1777	137	Fluorosulfonic acid	HF
1777	137	Fluorosulphonic acid	HF
1781	156	Hexadecyltrichlorosilane	HCl
1784	156	Hexyltrichlorosilane	HCl
1799	156	Nonyltrichlorosilane	HCl
1800	156	Octadecyltrichlorosilane	HCl
1801	156	Octyltrichlorosilane	HCl
1804	156	Phenyltrichlorosilane	HCl
1806	137	Phosphorus pentachloride	HCl
1808	137	Phosphorus tribromide	HBr
1809	137	Phosphorus trichloride	HCl
1810	137	Phosphorus oxychloride	HCl
1815	132	Propionyl chloride	HCl
1816	155	Propyltrichlorosilane	HCl
1818	157	Silicon tetrachloride	HCl
1828	137	Sulfur chlorides	HCl SO ₂ H ₂ S
1828	137	Sulphur chlorides	HCl SO ₂ H ₂ S
1834	137	Sulfuryl chloride	HCl
1834	137	Sulphuryl chloride	HCl
1836	137	Thionyl chloride	HCl SO ₂
1838	137	Titanium tetrachloride	HCl
1898	156	Acetyl iodide	HI
1923	135	Calcium dithionite	H ₂ S SO ₂

TABLE 2

Chemical Symbols for TIH (PIH in the US) Gases:

Br ₂	Bromine	HF	Hydrogen fluoride	NO ₂	Nitrogen dioxide
Cl ₂	Chlorine	HI	Hydrogen iodide	PH ₃	Phosphine
HBr	Hydrogen bromide	H ₂ S	Hydrogen sulfide	SO ₂	Sulfur dioxide
HCl	Hydrogen chloride	H ₂ S	Hydrogen sulphide	SO ₂	Sulphur dioxide
HCN	Hydrogen cyanide	NH ₃	Ammonia		

TABLE2 - WATER-REACTIVE MATERIALS WHICH PRODUCE TOXIC GASES

**Materials Which Produce Large Amounts of Toxic-by-Inhalation (TIH)
(PIH in the US) Gas(es) When Spilled in Water**

ID No.	Guide No.	Name of Material	TIH Gas(es) Produced
1923	135	Calcium hydrosulfite	H ₂ S SO ₂
1923	135	Calcium hydrosulphite	H ₂ S SO ₂
1929	135	Potassium dithionite	H ₂ S SO ₂
1929	135	Potassium hydrosulfite	H ₂ S SO ₂
1929	135	Potassium hydrosulphite	H ₂ S SO ₂
1931	171	Zinc dithionite	H ₂ S SO ₂
1931	171	Zinc hydrosulfite	H ₂ S SO ₂
1931	171	Zinc hydrosulphite	H ₂ S SO ₂
2004	135	Magnesium diamide	NH ₃
2011	139	Magnesium phosphide	PH ₃
2012	139	Potassium phosphide	PH ₃
2013	139	Strontium phosphide	PH ₃
2308	157	Nitrosylsulfuric acid, liquid	NO ₂
2308	157	Nitrosylsulphuric acid, liquid	NO ₂
2353	132	Butyryl chloride	HCl
2395	132	Isobutyryl chloride	HCl
2434	156	Dibenzylidichlorosilane	HCl
2435	156	Ethylphenyldichlorosilane	HCl
2437	156	Methylphenyldichlorosilane	HCl
2495	144	Iodine pentafluoride	HF
2691	137	Phosphorus pentabromide	HBr
2692	157	Boron tribromide	HBr
2806	139	Lithium nitride	NH ₃

Chemical Symbols for TIH (PIH in the US) Gases:

Br ₂	Bromine	HF	Hydrogen fluoride	NO ₂	Nitrogen dioxide
Cl ₂	Chlorine	HI	Hydrogen iodide	PH ₃	Phosphine
HBr	Hydrogen bromide	H ₂ S	Hydrogen sulfide	SO ₂	Sulfur dioxide
HCl	Hydrogen chloride	H ₂ S	Hydrogen sulphide	SO ₂	Sulphur dioxide
HCN	Hydrogen cyanide	NH ₃	Ammonia		

TABLE 2 - WATER-REACTIVE MATERIALS WHICH PRODUCE TOXIC GASES

**Materials Which Produce Large Amounts of Toxic-by-Inhalation (TIH)
(PIH in the US) Gas(es) When Spilled in Water**

ID No.	Guide No.	Name of Material	TIH Gas(es) Produced
2965	139	Boron trifluoride dimethyl etherate	HF
2977	166	Radioactive material, Uranium hexafluoride, fissile	HF
2977	166	Uranium hexafluoride, radioactive material, fissile	HF
2978	166	Radioactive material, Uranium hexafluoride, non fissile or fissile-excepted	HF
2978	166	Uranium hexafluoride, radioactive material, non fissile or fissile-excepted	HF
2985	155	Chlorosilanes, flammable, corrosive, n.o.s	HCl
2986	155	Chlorosilanes, corrosive, flammable, n.o.s	HCl
2987	156	Chlorosilanes, corrosive, n.o.s	HCl
2988	139	Chlorosilanes, water-reactive, flammable, corrosive, n.o.s.	HCl
3048	157	Aluminum phosphide pesticide	PH ₃
3361	156	Chlorosilanes, poisonous, corrosive, n.o.s.	HCl
3361	156	Chlorosilanes, toxic, corrosive, n.o.s.	HCl
3362	155	Chlorosilanes, poisonous, corrosive, flammable, n.o.s.	HCl
3362	155	Chlorosilanes, toxic, corrosive, flammable, n.o.s.	HCl
3456	157	Nitrosylsulfuric acid, solid	NO ₂
3456	157	Nitrosylsulphuric acid, solid	NO ₂
3507	166	Uranium hexafluoride, radioactive material, excepted package, less than 0.1 kg per package, non-fissile or fissile-excepted	HF
9191	143	Chlorine dioxide, hydrate, frozen	Cl ₂

TABLE 2

Chemical Symbols for TIH (PIH in the US) Gases:

Br ₂	Bromine	HF	Hydrogen fluoride	NO ₂	Nitrogen dioxide
Cl ₂	Chlorine	HI	Hydrogen iodide	PH ₃	Phosphine
HBr	Hydrogen bromide	H ₂ S	Hydrogen sulfide	SO ₂	Sulfur dioxide
HCl	Hydrogen chloride	H ₂ S	Hydrogen sulphide	SO ₂	Sulphur dioxide
HCN	Hydrogen cyanide	NH ₃	Ammonia		

**HOW TO USE TABLE 3 – INITIAL ISOLATION AND PROTECTIVE ACTION
DISTANCES FOR LARGE SPILLS FOR DIFFERENT QUANTITIES OF
SIX COMMON TIH (PIH in the US) GASES**

Table 3 lists Toxic Inhalation Hazard (TIH) materials that may be more commonly encountered.

The selected materials are:

- UN1005 - Ammonia, anhydrous
- UN1017 - Chlorine
- UN1040 - Ethylene oxide and UN1040 – Ethylene oxide with nitrogen
- UN1050 - Hydrogen chloride, anhydrous and UN2186 - and Hydrogen chloride, refrigerated liquid
- UN1052 - Hydrogen fluoride, anhydrous
- UN1079 - Sulfur dioxide/Sulphur dioxide

The materials are presented in numerical order of ID number and provide Initial Isolation and Protective Action Distances **FOR LARGE SPILLS** (more than 208 liters or 55 US gallons) involving different container types (therefore different volume capacities, see below) for day time and night time situations and different wind speeds.

- Rail tank car: 80 000 kg (176 368 lbs.)
- Highway tank truck or trailer: 20 000 – 25 000 kg (44 092 – 55 115 lbs.)
- Agricultural nurse tank: 3785 L (1000 gallons)
- Small cylinder: 72 L (19 gallons)
- Ton cylinder: 757 - 1135 L (200 - 300 gallons)

Estimating Wind Speed from Environmental Clues

mph	km/h	Wind Description	Specifications
< 6	< 10	Low wind	Wind felt on face; leaves rustle; ordinary vane moved by wind
6 - 12	10 - 20	Moderate wind	Raises dust, loose paper; small branches are moved
> 12	> 20	High wind	Large branches in motion; whistling heard in telephone wires; umbrellas used with difficulty

(Data taken from the Beaufort Wind Scale has been reworked in order to create 3 categories of wind speed: Low, Moderate and High)

TABLE 3 - INITIAL ISOLATION AND PROTECTIVE ACTION DISTANCES FOR LARGE SPILLS FOR DIFFERENT QUANTITIES OF SIX COMMON TIH (PIH in the US) GASES

	First ISOLATE in all Directions	Then PROTECT persons Downwind during							
		DAY				NIGHT			
		Low wind (< 6 mph = < 10 km/h)	Moderate wind (6-12 mph = 10 - 20 km/h)	High wind (> 12 mph = > 20 km/h)	Low wind (< 6 mph = < 10 km/h)	Moderate wind (6-12 mph = 10 - 20 km/h)	High wind (> 12 mph = > 20 km/h)	Low wind (< 6 mph = < 10 km/h)	Moderate wind (6-12 mph = 10 - 20 km/h)
Meters (Feet)	km (Miles)	km (Miles)	km (Miles)	km (Miles)	km (Miles)	km (Miles)	km (Miles)	km (Miles)	
UN1005 Ammonia, anhydrous: Large Spills									
TRANSPORT CONTAINER									
Rail tank car	300 (1000)	1.9 (1.2)	1.5 (0.9)	1.1 (0.6)	4.5 (2.8)	2.5 (1.5)	1.4 (0.9)		
Highway tank truck or trailer	150 (500)	0.9 (0.6)	0.5 (0.3)	0.4 (0.3)	2.0 (1.3)	0.8 (0.5)	0.6 (0.4)		
Agricultural nurse tank	60 (200)	0.5 (0.3)	0.3 (0.2)	0.3 (0.2)	1.4 (0.9)	0.3 (0.2)	0.3 (0.2)		
Multiple small cylinders	30 (100)	0.3 (0.2)	0.2 (0.1)	0.1 (0.1)	0.7 (0.5)	0.3 (0.2)	0.2 (0.1)		
UN1017 Chlorine: Large Spills									
TRANSPORT CONTAINER									
Rail tank car	1000 (3000)	10.1 (6.3)	6.8 (4.2)	5.3 (3.3)	11+ (7+)	9.2 (5.7)	6.9 (4.3)		
Highway tank truck or trailer	600 (2000)	5.8 (3.6)	3.4 (2.1)	2.9 (1.8)	6.7 (4.3)	5.0 (3.1)	4.1 (2.5)		
Multiple ton cylinders	300 (1000)	2.1 (1.3)	1.3 (0.8)	1.0 (0.6)	4.0 (2.5)	2.4 (1.5)	1.3 (0.8)		
Multiple small cylinders or single ton cylinder	150 (500)	1.5 (0.9)	0.8 (0.5)	0.5 (0.3)	2.9 (1.8)	1.3 (0.8)	0.6 (0.4)		

TABLE 3

"+" means distance can be larger in certain atmospheric conditions

TABLE 3 - INITIAL ISOLATION AND PROTECTIVE ACTION DISTANCES FOR LARGE SPILLS FOR DIFFERENT QUANTITIES OF SIX COMMON TH (PIH in the US) GASES

		Then PROTECT persons Downwind during					
		DAY			NIGHT		
First ISOLATE in all Directions	Meters (Feet)	Low wind (<6 mph = <10 km/h)	Moderate wind (6-12 mph = 10 - 20 km/h)	High wind (> 12 mph = > 20 km/h)	Low wind (<6 mph = < 10 km/h)	Moderate wind (6-12 mph = 10 - 20 km/h)	High wind (> 12 mph = > 20 km/h)
		km (Miles)	km (Miles)	km (Miles)	km (Miles)	km (Miles)	km (Miles)
TRANSPORT CONTAINER		UN1040 Ethylene oxide: Large Spills					
UN1040 Ethylene oxide with Nitrogen: Large Spills							
Rail tank car	200 (600)	1.6 (1.0)	0.8 (0.5)	0.7 (0.5)	3.3 (2.1)	1.4 (0.9)	0.8 (0.5)
Highway tank truck or trailer	100 (300)	0.9 (0.6)	0.5 (0.3)	0.4 (0.3)	2.0 (1.3)	0.7 (0.4)	0.4 (0.3)
Multiple small cylinders or single ton cylinder	30 (100)	0.4 (0.3)	0.2 (0.1)	0.1 (0.1)	0.9 (0.6)	0.3 (0.2)	0.2 (0.1)
TRANSPORT CONTAINER		UN1050 Hydrogen chloride, anhydrous: Large Spills					
UN2186 Hydrogen chloride, refrigerated liquid: Large Spills							
Rail tank car	500 (1500)	3.9 (2.5)	2.1 (1.2)	1.8 (1.2)	10.1 (6.3)	3.5 (2.2)	2.3 (1.5)
Highway tank truck or trailer	200 (600)	1.5 (0.9)	0.8 (0.5)	0.6 (0.4)	3.9 (2.5)	1.5 (0.9)	0.8 (0.5)
Multiple ton cylinders	30 (100)	0.4 (0.3)	0.2 (0.1)	0.1 (0.1)	1.1 (0.7)	0.3 (0.2)	0.2 (0.1)
Multiple small cylinders or single ton cylinder	30 (100)	0.3 (0.2)	0.2 (0.1)	0.1 (0.1)	0.9 (0.6)	0.3 (0.2)	0.2 (0.1)

TABLE 3 - INITIAL ISOLATION AND PROTECTIVE ACTION DISTANCES FOR LARGE SPILLS FOR DIFFERENT QUANTITIES OF SIX COMMON TIH (PIH in the US) GASES

	First ISOLATE in all Directions	Then PROTECT persons Downwind during					
		DAY			NIGHT		
		Low wind (< 6 mph = < 10 km/h)	Moderate wind (6-12 mph = 10 - 20 km/h)	High wind (> 12 mph = > 20 km/h)	Low wind (< 6 mph = < 10 km/h)	Moderate wind (6-12 mph = 10 - 20 km/h)	High wind (> 12 mph = > 20 km/h)
Meters (Feet)	km (Miles)	km (Miles)	km (Miles)	km (Miles)	km (Miles)		
TRANSPORT CONTAINER							
UN1052 Hydrogen fluoride, anhydrous: Large Spills							
Rail tank car	500 (1500)	3.5 (2.2)	2.1 (1.3)	1.8 (1.2)	6.6 (4.1)	3.1 (1.9)	2.0 (1.2)
Highway tank truck or trailer	200 (700)	2.0 (1.2)	1.0 (0.7)	0.9 (0.6)	3.7 (2.3)	1.6 (1.0)	0.9 (0.6)
Multiple small cylinders or single ton cylinder	100 (300)	0.8 (0.5)	0.4 (0.2)	0.3 (0.2)	1.7 (1.1)	0.5 (0.3)	0.3 (0.2)
TRANSPORT CONTAINER							
UN1079 Sulfur dioxide/Sulphur dioxide: Large Spills							
Rail tank car	1000 (3000)	11+ (7+)	11+ (7+)	7.2 (4.5)	11+ (7+)	11+ (7+)	10.1 (6.3)
Highway tank truck or trailer	1000 (3000)	11+ (7+)	6.2 (3.8)	5.3 (3.3)	11+ (7+)	8.2 (5.1)	6.2 (3.9)
Multiple ton cylinders	500 (1500)	5.4 (3.4)	2.4 (1.5)	1.8 (1.1)	7.8 (4.8)	4.2 (2.6)	2.9 (1.8)
Multiple small cylinders or single ton cylinder	200 (600)	3.2 (2.0)	1.5 (0.9)	1.1 (0.7)	5.8 (3.6)	2.5 (1.6)	1.5 (0.9)

TABLE 3

"+" means distance can be larger in certain atmospheric conditions

ERG2020 USER'S GUIDE

For the purposes of this guidebook, the terms hazardous materials/dangerous goods are synonymous.

The 2020 Emergency Response Guidebook (ERG2020) was developed jointly by Transport Canada (TC), the U.S. Department of Transportation (DOT), and the Secretariat of Communications and Transport of Mexico (SCT), with help from CIQUIME (Centro de Información Química para Emergencias) of Argentina.

This guidebook is for firefighters, police and other emergency services personnel who may be first to arrive at the scene of a transportation incident involving dangerous goods.

It is primarily a guide to help first responders to quickly:

- **identify the specific or generic hazards of material(s) involved in a transportation incident**
- **protect themselves and the general public during the initial response phase of the incident**

For the purposes of this guidebook, “initial response phase” is the period after first responders arrive at the scene of an incident. During this phase, responders:

- confirm the presence and/or identification of dangerous goods
- start taking protective action and securing the area
- request the help of qualified personnel

This guide is designed for use at a dangerous goods incident on a highway or railroad. It may have limited value at fixed-facility locations, or onboard aircrafts or vessels.

This guide **does not**:

- provide information on the physical or chemical properties of dangerous goods
- replace emergency response training, knowledge, or sound judgment
- address all possible circumstances that may be associated with a dangerous goods incident

ERG2020 incorporates dangerous goods lists from the most recent United Nations Recommendations, and from other international and national regulations.

Explosives are not listed individually (by either proper shipping name or ID number) but, under the general heading “Explosives”, they do appear:

- on the first page of the ID Number index (yellow-bordered pages)
- alphabetically in the Name of Material index (blue-bordered pages)

Chemical warfare agents do not have an assigned ID number because they are not commercially transported. In an emergency situation, the assigned guide (orange-bordered pages) will provide guidance for the initial response.

The letter **(P)** following the guide number in the yellow and blue bordered pages identifies materials that present a polymerization hazard under certain conditions. For example: UN1092 - Acrolein, stabilized GUIDE **131P**.

First responders at the scene of a dangerous goods incident should not solely rely on this guidebook. Always seek specific information about any material in question as soon as possible. To do so:

- Contact the appropriate emergency response agency listed on the inside back cover.
- Call the emergency response telephone number on the shipping paper.
- Consult information on or accompanying the shipping paper.

BEFORE AN EMERGENCY – BECOME FAMILIAR WITH THIS GUIDEBOOK! In the U.S., according to the requirements of the U.S. Department of Labor's Occupational Safety and Health Administration (OSHA, 29 CFR 1910.120) and regulations issued by the U.S. Environmental Protection Agency (EPA, 40 CFR Part 311), first responders must be trained in how to use this guidebook.

GUIDEBOOK CONTENTS

1- Yellow-bordered pages: Index list of dangerous goods in order of ID number. The list displays the 4-digit ID followed by its assigned emergency response guide and material name.

For example:	ID No.	GUIDE No.	Name of Material
	1090	127	Acetone

2- Blue-bordered pages: Index list of dangerous goods in alphabetical order of material name. The list displays the name followed by its assigned emergency response guide and 4-digit ID number.

For example:	Name of Material	GUIDE No.	ID No.
	Sulfuric acid	137	1830

3- Orange-bordered pages: All safety recommendations are provided here. It is made up of 62 individual guides in a 2-page format. Each guide recommends safety and emergency response procedures to protect yourself and the public. The left-hand page gives safety-related information and evacuation distances. The right-hand page gives emergency response guidance for fires, spills or leaks, and first aid. Each guide applies to a group of materials with similar chemical and toxicological characteristics. The guide title identifies the general hazards of the dangerous goods.

For example: GUIDE 124 - **Gases - Toxic and/or Corrosive - Oxidizing.**

Each guide is divided into 3 main sections:

POTENTIAL HAZARDS:

- Displays the hazards in terms of **FIRE OR EXPLOSION** and **HEALTH** effects upon exposure.
- Primary potential hazard is listed first.
- Consult this section first to help you make decisions about how to protect the emergency response team and surrounding population.

PUBLIC SAFETY:

- Provides general information on initial precautionary measures to be taken by those first on scene.
- Provides general guidance on **PROTECTIVE CLOTHING** requirements and respiratory protection.
- Lists suggested **EVACUATION** distances for immediate precautionary measures, spills, and for fires (fragmentation hazard).
- When the material is highlighted in green in the yellow and blue bordered pages, it directs the reader to consult Table 1, which lists Toxic Inhalation Hazard (TIH) (PIH in the U.S.) materials, water-reactive materials and chemical warfare agents (green-bordered pages).

EMERGENCY RESPONSE:

- Outlines special precautions for incidents that involve **FIRE**, **SPILL OR LEAK** or chemical exposure.
- Lists several recommendations under each part to further assist your decision-making process.
- Provides general **FIRST AID** guidance to use before seeking medical care.

4- Green-bordered pages: This section has 3 tables.

Table 1 - Initial Isolation and Protective Action Distances

Lists, by order of ID number:

- TIH (PIH in the U.S.) materials
- water-reactive materials that produce toxic gases upon contact with water
- certain chemical warfare agents

These materials are highlighted in green in the yellow and blue bordered pages so you can easily identify them.

Table 1 provides two types of recommended safety distances: “**initial isolation distances**” and “**protective action distances**” for:

- **small spills:** 208 liters (55 US gallons) or less
- **large spills:** more than 208 liters (55 US gallons)
- Exception: For entries marked (**when used as a weapon**), volumes vary, but in most cases, small spills include releases up to 2 kg (4.4 lbs.), and large spills include releases up to 25 kg (55 lbs.).

Within the “**initial isolation distance**”, protective clothing and respiratory protection is required. You should consider evacuating all people **in all directions** from the spill or leak source. This distance defines the radius of the “initial isolation zone” surrounding the spill in which people may be exposed to:

- dangerous concentrations upwind of the source
- life-threatening concentrations downwind of the source

The “**protective action distances**” are downwind distances from the spill or leak source, within which responders could carry out protective actions to:

- preserve the health and safety of emergency responders and the public
- evacuate and/or shelter-in-place people in this area (For more information, consult pp. 289 to 291)

The “protective action distance” is divided into **daytime** and **nighttime** incidents because varying atmospheric conditions affect a hazardous area’s size. In fact, the quantity or concentration of the material’s vapor poses problems, not its mere presence. During the night, the air is generally calmer. This causes the vapor to disperse less and therefore creates a greater toxic zone. In daytime, the atmosphere is more active, so the vapor disperses more. As a result, there is a lower concentration of vapor in the surrounding air and the area that reaches toxic levels is smaller. Daytime is after sunrise and before sunset. Nighttime is between sunset and sunrise.

For example, in the case of a small spill of UN1955 - compressed gas, toxic, n.o.s., the “**initial isolation distance**” is 100 meters (300 feet); therefore its “initial isolation zone” is 200 meters (600 feet) in diameter. Its “**protective action distance**” is 0.5 kilometers (0.3 miles) for daytime and 2.5 kilometers (1.6 miles) for nighttime.

Note 1: Some water-reactive materials have 2 entries in Table 1. They are identified by (**when spilled on land**) since they are TIH products and (**when spilled in water**) because they produce additional toxic gases when spilled in water.

For example: UN1746 - Bromine trifluoride and UN1836 - Thionyl chloride.

Note 2: If a water-reactive material only has one entry in Table 1 for (**when spilled in water**) and the product is NOT spilled in water, Table 1 and Table 2 do not apply. You will find safe distances in the appropriate orange-bordered guide.

For example: UN1183 - Ethyldichlorosilane and UN1898 – Acetyl iodide.

Table 2 - Water-Reactive Materials Which Produce Toxic Gases

Lists:

- by order of ID number, materials that produce large amounts of Toxic Inhalation Hazard (TIH) gases when spilled in water; and
- TIH gases produced by these materials.

You can easily identify water-reactive materials in **Table 1**, as their names are immediately followed by **(when spilled in water)**.

NOTE: The TIH gases indicated in Table 2 are for information purposes only. These TIH gases have already been taken into consideration in the distances of Table 1.

For example, Table 2 indicates that UN1689 sodium cyanide, when spilled in water, will generate hydrogen cyanide gas (HCN). In Table 1, you must refer to the distances for sodium cyanide, solid and not the distances for hydrogen cyanide gas.

Table 3 - Initial Isolation and Protective Action Distances for Large Spills for Different Quantities of Six Common TIH Gases

Lists the following 6 most common TIH materials:

- UN1005 - Ammonia, anhydrous
- UN1017 - Chlorine
- UN1040 - Ethylene oxide and UN1040 - Ethylene oxide with nitrogen
- UN1050 - Hydrogen chloride, anhydrous and UN2186 - Hydrogen chloride, refrigerated liquid
- UN1052 - Hydrogen fluoride, anhydrous
- UN1079 - Sulfur dioxide/Sulphur dioxide

Table 3 shows:

- initial isolation and protective action distances for large spills (more than 208 liters or 55 US gallons)
- different container types (therefore different volume capacities) for daytime and nighttime, and for three different wind speeds (low, moderate and high)

HOW TO CHOOSE THE APPROPRIATE ISOLATION AND PROTECTIVE ACTION DISTANCES

ERG2020 lists isolation or evacuation distances in 2 places:

- the individual guides (orange-bordered pages)
- Table 1 – Initial Isolation and Protective Action Distances (green-bordered pages)

If you are dealing with a **non-TIH material** (not highlighted in green in the yellow-bordered or blue-bordered pages),

- Go to the assigned guide for the material (orange-bordered pages).
- Under **EVACUATION**, you will find:
 - initial isolation distance as an immediate precautionary measure
 - specific distances for spill or fire situations (fragmentation hazard)
 - **Please note** that certain guides may also refer to Table 1. This is just a reminder for green highlighted materials only.

If you are dealing with a **TIH, water-reactive** or **chemical warfare** material (green highlighted entries in the yellow or blue bordered pages):

If there is no fire:

- Go directly to Table 1 – Initial Isolation and Protective Action Distances (green-bordered pages).
- Also, consult the assigned guide for the material (orange-bordered pages).

If a fire is involved:

- Go directly to the assigned guide (orange-bordered pages) and apply the distances found under **EVACUATION** - Fire.
- Also, consult Table 1 distances for residual material release.

PROTECTIVE CLOTHING

STREET CLOTHING AND WORK UNIFORMS

These garments, such as uniforms worn by police and emergency medical services personnel, provide almost no protection from the harmful effects of hazardous materials/dangerous goods.

STRUCTURAL FIREFIGHTERS' PROTECTIVE CLOTHING (SFPC)

This category of clothing, often called turnout or bunker gear, is the protective clothing firefighters normally wear during structural firefighting operations. It includes a helmet, coat, pants, boots, gloves and a hood to cover parts of the head that are not protected by the helmet and facepiece. It can be used with full-facepiece positive pressure self-contained breathing apparatus (SCBA). It should, at minimum, meet the OSHA Fire Brigades Standard (29 CFR 1910.156) or NFPA 1851.

Structural firefighters' protective clothing provides limited protection from heat and cold. It may not provide adequate protection from harmful vapors or liquids encountered during hazardous materials/dangerous goods incidents.

Each guide includes a statement about the use of SFPC in incidents involving the materials referenced by that guide. Some guides state that SFPC provides limited protection. In those cases, the responder wearing SFPC and SCBA may be able to perform a quick "in-and-out" operation. However, this type of operation can place the responder at risk of exposure, injury or death. The incident commander makes the decision to do this only if there is an overriding benefit (for example, to perform an immediate rescue, turn off a valve to control a leak, etc.).

Please note that the coverall-type protective clothing customarily worn to fight fires in forests or wildlands is not SFPC and **is not** recommended nor referred to elsewhere in this guidebook.

POSITIVE PRESSURE SELF-CONTAINED BREATHING APPARATUS (SCBA)

This apparatus provides a constant, positive pressure flow of air within the facepiece.

You should always use an SCBA certified by NIOSH and the Department of Labor/Mine Safety and Health Administration, in accordance with:

- 42 CFR Part 84
- requirements for respiratory protection specified in OSHA 29 CFR 1910.134 (Respiratory Protection) and/or 29 CFR 1910.156 (f) (Fire Brigades Standard)
- NFPA 1852

Chemical-cartridge respirators or other filtering masks are not acceptable substitutes for positive pressure SCBA. Demand-type SCBA does not meet the OSHA 29 CFR 1910.156 (f)(1)(i) of the Fire Brigades Standard.

RESPIRATORS

If you suspect a chemical warfare agent is involved in an incident, use NIOSH-certified respirators with CBRN protection.

N95 respirators are the most common of the seven types of particulate filtering facepiece respirators. This product filters at least 95% of airborne particles (0.3 microns), but is not resistant to oil. N95 filtering facepiece respirators do not protect against gases and vapors.

Powered air-purifying respirators (PAPR) force ambient air through the air-purifying cartridge or filter into the facepiece. A PAPR does not supply oxygen or air from a separate source (e.g., cylinders).

CHEMICAL PROTECTIVE CLOTHING AND EQUIPMENT

For you to safely use this type of protective clothing and equipment, you need specific skills developed through training and experience. This type of special clothing may protect against one chemical but be readily permeated by chemicals for which it was not designed. Therefore, do not use this type of protective clothing unless it is compatible with the released material. Also, be aware that it offers little or no protection against heat and/or cold.

Examples of this type of equipment have been described as:

- (1) Vapor Protective Suits (NFPA 1991), also known as Totally-Encapsulating Chemical Protective Suits or Level A* protection (OSHA 29 CFR 1910.120, Appendix A & B)
- (2) Liquid-Splash Protective Suits (NFPA 1992), also known as Level B* or C* protection (OSHA 29 CFR 1910.120, Appendix A & B), or suits for chemical/biological terrorism incidents (NFPA 1994), class 1, 2 or 3 Ensembles and Standard CAN/CGSB/CSA-Z1610-11 – Protection of first responders from chemical, biological, radiological, and nuclear (CBRN) events

No single protective clothing material will protect you from all hazardous materials/dangerous goods. Do not assume any protective clothing is resistant to cold and/or heat or flame exposure, unless certified by the manufacturer (NFPA 1991 5-3 Flammability Resistance Test and 5-6 Cold Temperature Performance Test).

*Consult the glossary for more information about protection levels under the heading “Protective Clothing.”

DECONTAMINATION

The ways to decontaminate people and equipment can vary. If you need help with decontamination, contact the emergency response telephone number provided on the shipping papers or the agencies listed on the inside back cover. These resources may be able to put you in contact with the chemical manufacturer to determine the appropriate procedure if not otherwise available.

Decontamination is the process of removing or neutralizing hazardous materials/dangerous goods that have contaminated people and equipment during an incident.

Contamination happens in the area generally referred to as the Hot Zone. Everything and everyone entering this zone should be decontaminated when leaving, including emergency response personnel. This reduces the chances that more contamination will occur.

There are two main types of contamination:

- **Direct contamination** happens in the Hot Zone.
- **Cross contamination** happens when someone or something outside the Hot Zone was not properly decontaminated and comes in contact with another object or person, usually in the Warm or Cold Zone.

To decontaminate, you must:

- physically remove contaminants; and/or
- chemically neutralize contaminants*.

The NFPA 472, Chapter 3, describes the following four kinds of decontamination.

- (1) **Gross decontamination:** Quickly removing surface contamination, which usually happens by mechanically removing the contaminant or rinsing with water from handheld hose lines, emergency showers, or other nearby water sources.
- (2) **Technical decontamination:** Reducing contamination to a level as low as possible by chemical or physical methods. A hazmat team will perform this kind of decontamination.
- (3) **Mass decontamination:** Reducing or removing surface contaminants as fast as possible from a large number of people in potentially life-threatening situations.
- (4) **Emergency decontamination:** Immediately reducing contamination of people in potentially life-threatening situations with or without formally setting up a decontamination corridor. This process should be performed upwind and uphill from victims. Responders should avoid contact with victims, runoff or spray from the decontamination process.

Emergency and mass decontamination can be done with firefighting and rescue operations equipment. Nozzles can be put on wide-angle fog patterns and sprayed towards the ground to create a decontamination shower. Responders can also place nozzles on the discharge ports of engines.

Contaminated clothing and equipment must be removed after use and stored in a controlled area (Warm Zone) until cleanup procedures can begin. Sometimes protective clothing and equipment cannot be decontaminated and must be disposed of properly.

*Chemical neutralization releases heat. DO NOT PERFORM on a victim.

FIRE AND SPILL CONTROL

FIRE CONTROL

Water is the most common and generally most available fire extinguishing agent. Use caution in selecting a fire extinguishing method, as there are many factors to consider. Water may be ineffective in fighting fires that involve some materials.

Fires Involving a Spill of Flammable Liquids

These fires are usually controlled by applying a firefighting foam to the surface of the burning material.

Fighting flammable liquid fires requires:

- foam concentrate that is chemically compatible with the burning material
- correct mixing of the foam concentrate with water and air
- careful application and maintenance of the foam blanket

There are two general types of firefighting foam: regular and alcohol-resistant. Examples of regular foam are protein-base, fluoroprotein, and aqueous film-forming foam (AFFF).

You can control some flammable liquid fires, including many petroleum products, by applying regular foam. Other flammable liquids, including polar solvents (flammable liquids that are water soluble), such as alcohols and ketones, have different chemical properties. You cannot easily control a fire that involves these materials with regular foam, and should use alcohol-resistant foam instead.

Polar solvent fires may be difficult to control and require a higher foam application rate than other flammable liquid fires (see NFPA Standards 11 for further information). Refer to the appropriate guide to determine which type of foam to use. For flammable liquids which have subsidiary corrosive or toxic hazards, it is difficult to make specific recommendations. However, alcohol-resistant foam may be effective for many of these materials.

Contact the emergency response telephone number on the shipping paper, or the appropriate emergency response agency, as soon as possible for guidance on the proper fire extinguishing agent to use.

How you decide to control the fire depends on factors such as:

- incident location
- exposure hazards
- size of the fire
- environmental concerns
- availability of extinguishing agents and equipment at the scene

WATER-REACTIVE MATERIALS

Water is sometimes used to flush spills and reduce or direct vapors in spill situations. Some of the materials covered by this guidebook can react violently or even explosively with water. In these cases, consider letting the fire burn or leaving the spill alone (except to prevent its spreading by diking) until you can get more technical advice.

The applicable guides clearly warn you of these potentially dangerous reactions. Technical advice is required for these materials since:

- Water getting inside a ruptured or leaking container may cause an explosion.
- You may need to cool adjoining containers with water to prevent them from rupturing (exploding), or to prevent the fire spreading further.
- Water may be effective in mitigating an incident involving a water-reactive material, but only if you can apply it at a **sufficient flooding rate for a long period**.
- Products from the reaction with water may be more toxic, corrosive or undesirable than the product that caused the fire.

When you respond to an incident involving water-reactive materials, take into account:

- existing conditions, such as wind, precipitation, location and accessibility to the incident
- availability of agents to control the fire or spill

Because there are variables to consider, base your decision to use water on fires or spills involving water-reactive materials on information from a reliable source. For example, consult the material's manufacturer through the emergency response telephone number or the appropriate emergency response agency listed on the inside back cover.

VAPOR CONTROL

Limiting the amount of vapor released from a pool of flammable or corrosive liquids is an operational concern. It requires proper protective clothing, specialized equipment, appropriate chemical agents and skilled personnel. Before you engage in vapor control, seek advice on tactics to be used from qualified personnel.

There are several ways to minimize the amount of vapors escaping from pools of spilled liquids, such as special foams, adsorbing agents, absorbents, and neutralizing agents. To be effective, you must select a method for the specific material involved, and use it in a way that mitigates, not worsens, the incident.

Where specific materials are known, such as at a manufacturing or storage facilities, the hazardous materials/dangerous goods response team should prearrange with the facility operators to select and stockpile these control agents before a spill.

In the field, first responders may not have the most effective vapor control agent for the material available. They will be more likely to have only water, and only one type of firefighting foam on their vehicles. If the available foam is not appropriate, they will probably use water spray. Because water is being used to form a vapor seal, care must be taken not to churn or further spread the spill during application. Vapors that do not react with water may be directed away from the site using the air currents surrounding the water spray. Before using water spray or other methods to safely control vapor emission or suppress ignition, get technical advice based on a specific chemical name.

BLEVE AND HEAT INDUCED TEAR

BLEVE (BOILING LIQUID EXPANDING VAPOR EXPLOSION)

The following pages present important safety-related information on BLEVEs, including a table, to consider in a situation involving Liquefied Petroleum Gases (LPG), UN1075.

LPGs include the following flammable gases:

- UN1011 - Butane
- UN1012 - Butylene
- UN1055 - Isobutylene
- UN1077 - Propylene
- UN1969 - Isobutane
- UN1978 - Propane

A BLEVE occurs when a fire impinged or damaged tank car fails to contain its internal pressure and explodes with a sudden product release. This catastrophic failure is more likely to occur with damaged pressure tank cars, even in the absence of an active fire.

The **main hazards** from a LPG BLEVE are:

- **Fire:** If the released substance is ignited, there is an immediate fireball.
- **Thermal radiation:** At a distance of about 4 times the radius of a fireball, the heat radiated from a fireball is enough to burn exposed skin in 2 seconds. Wearing protective clothing limits the thermal radiation dose.
- **Blast:** A concussive force caused by the sudden release of the pressurized substance. For a BLEVE occurring out in the open, the blast strength at a distance of 4 times the radius of a fireball can break window glass and may cause minor damage to buildings.
- **Projectiles:** Tank failure can throw metal fragments over large distances. These fragments can and have been deadly.

The danger decreases as you move away from the BLEVE centre. The furthest-reaching hazard is projectiles.

For a video with information on critical safety issues concerning BLEVEs, please visit <http://www.tc.gc.ca/eng/tdg/publications-menu-1238.html>.

HEAT INDUCED TEAR (HIT)

A heat induced tear (HIT) is a rupture of a NON-PRESSURE tank car containing flammable liquids when exposed to the intense heat of a fire. The metal will soften and the pressure in the tank car will increase which can lead to containment failure. The tear generally occurs at the vapor space (upper side) of the container, venting large quantities of flammable liquid and vapors at high speed. A fireball and an intense heat wave will occur.

Compared to BLEVEs, HITs rarely result in the projection of tank car fragments. Heat induced tearing has occurred within 20 minutes of the derailment and as long as 10+ hours following the initial fire.

Responding to these types of incidents (BLEVE and HIT) requires specialized training, equipment and a tactical approach.

BLEVE – SAFETY PRECAUTIONS

Use with caution. The following table gives a summary of tank properties, critical times, critical distances and cooling water flow rates for various tank sizes. This table is provided to give responders some guidance but it should be used with caution.

Tank dimensions are approximate and can vary depending on the tank design and application.

Minimum time to failure is based on **severe torch fire impingement** on the vapor space of a tank in good condition, and is approximate. Tanks may fail earlier if they are damaged or corroded. Tanks may fail minutes or hours later than these minimum times depending on the conditions. It has been assumed here that the tanks are not equipped with thermal barriers or water spray cooling.

Minimum time to empty is based on an engulfing fire with a properly sized pressure relief valve. If the tank is only partially engulfed, then time to empty will increase (i.e., if tank is 50% engulfed, then the tanks will take twice as long to empty). Once again, it has been assumed that the tank is not equipped with a thermal barrier or water spray.

Tanks equipped with thermal barriers or water spray cooling significantly increase the times to failure and the times to empty. A thermal barrier can reduce the heat input to a tank by a factor of ten or more. This means it could take ten times as long to empty the tank through the Pressure Relief Valve (PRV).

Fireball radius and emergency response distance is based on mathematical equations and is approximate. They assume spherical fireballs and this is not always the case.

Two safety distances for public evacuation. The minimum distance is based on tanks that are launched with a small elevation angle (i.e., a few degrees above horizontal). This is most common for horizontal cylinders. The preferred evacuation distance has more margin of safety since it assumes the tanks are launched at a 45 degree angle to the horizontal. This might be more appropriate if a vertical cylinder is involved.

It is understood that these distances are very large and may not be practical in a highly populated area. However, it should be understood that the risks increase rapidly the closer you are to a BLEVE. Keep in mind that the furthest reaching projectiles tend to come off in the zones 45 degrees on each side of the tank ends.

Water flow rate is based on $5 (\sqrt{\text{capacity (USgal)}}) = \text{USgal/min}$ needed to cool tank metal.

Warning: the data given are approximate and should only be used with extreme caution. For example, where times are given for tank failure or tank emptying through the pressure relief valve – these times are typical but they can vary from situation to situation. Therefore, never risk life based on these times.

WARNING:

The data given are approximate and should only be used with extreme caution. These times can vary from situation to situation. LPG tanks have been known to BLEVE within minutes. Therefore, never risk life based on these times.

BLEVE (USE WITH CAUTION)

Capacity Litres (Gallons)	Diameter Meters (Feet)	Length Meters (Feet)	Propane Mass Kilograms (Pounds)	Minimum time to failure for severe torch	Approximate time to empty for engulfing fire	Fireball radius Meters (Feet)	Emergency response distance Meters (Feet)	Minimum evacuation distance Meters (Feet)	Preferred evacuation distance Meters (Feet)	Cooling water flow rate	
										Litres/min	USgal/min
100 (26.4)	0.3 (1)	1.5 (4.9)	40 (88)	4	8	10 (33)	90 (295)	154 (505)	307 (1007)	97	26
400 (106)	0.61 (2)	1.5 (4.9)	160 (353)	4	12	16 (53)	90 (295)	244 (801)	488 (1601)	195	51
2000 (528)	0.96 (3.2)	3 (9.8)	800 (1764)	5	18	28 (92)	111 (364)	417 (1368)	834 (2736)	435	115
4000 (1057)	1 (3.3)	4.9 (16.1)	1600 (3527)	5	20	35 (115)	140 (459)	525 (1722)	1050 (3445)	615	163
8000 (2113)	1.25 (4.1)	6.5 (21.3)	3200 (7055)	6	22	44 (144)	176 (577)	661 (2169)	1323 (4341)	870	230
22000 (5812)	2.1 (6.9)	6.7 (22)	8800 (19400)	7	28	62 (203)	247 (810)	926 (3038)	1852 (6076)	1443	381
42000 (11095)	2.1 (6.9)	11.8 (38.7)	16800 (37037)	7	32	77 (253)	306 (1004)	1149 (3770)	2200 (7218)	1994	527
82000 (21662)	2.75 (9)	13.7 (45)	32800 (72310)	8	40	96 (315)	383 (1257)	1435 (4708)	2200 (7218)	2786	736
140000 (36984)	3.3 (10.8)	17.2 (56.4)	56000 (123457)	9	45	114 (374)	457 (1499)	1715 (5627)	2200 (7218)	3640	962

CRIMINAL OR TERRORIST USE OF CHEMICAL, BIOLOGICAL AND RADIOLOGICAL AGENTS

If you suspect an intentional release of a chemical, biological or radiological agent (CBRN), you should immediately contact your local emergency response authorities (911). Additionally, for CBRN incidents occurring:

- within the United States, call the National Response Center at 1-800-424-8802
- within Canada, call CANUTEC at 613-996-6666 (1-888-226-8832)
- within Mexico, call CENACOM at 555128-0000 extensions 36428, 36422, 36469, 37807, 37810
- in other countries, consult page 392

The following is general guidance and does not serve as specialized incident response training. Do not enter the scene without appropriate training and equipment.

First responders can use the following information to make an initial assessment of a situation they suspect involves criminal or terrorist use of chemical agents, biological agents and/ or radioactive materials (CBRN). To help with this, the following paragraphs have a list of observable indicators that a CB agent or radioactive material has been used or is present. This section ends with a Safe Stand-Off Distance Chart for various threats when improvised explosive devices (IEDs) are involved.

DIFFERENCES BETWEEN A CHEMICAL, BIOLOGICAL AND RADIOLOGICAL AGENT

Chemical and biological agents as well as radioactive materials can be dispersed in the air we breathe, the water we drink, or on surfaces we physically contact. Dispersion methods may be as simple as opening a container or using conventional (garden) spray devices, or as elaborate as detonating an improvised explosive device.

Chemical incidents are characterized by the rapid onset of medical symptoms (in minutes to hours) and easily observed signatures (colored residue, dead foliage, pungent odor, dead insects and animals).

Biological incidents are characterized by the onset of symptoms in hours to days. Typically, there will be no characteristic signatures because biological agents are usually odorless and colorless. Because of the delayed onset of symptoms, the affected area may be greater due to the movement of infected people.

Radiological incidents are characterized by the onset of symptoms, if any, in days to weeks or longer. Typically, there will be no characteristic signatures because radioactive materials are usually odorless and colorless. Specialized equipment is needed to determine the size of the affected area, and if the level of radioactivity is an immediate or long-term health hazard. Because it is impossible to detect radioactivity without special equipment, the affected area may be greater due to the migration of contaminated people.

The most probable sources would not generate enough radiation to kill people or cause severe illness. In a radiological incident generated by a “dirty bomb,” or radiological dispersal device (RDD), in which a conventional explosive is detonated to spread radioactive contamination, the primary hazard is from the explosion. However, certain radioactive materials dispersed in the air could contaminate up to several city blocks, creating fear and possibly panic, and needing potentially costly cleanup.

INDICATORS OF A POSSIBLE CHEMICAL INCIDENT

Dead animals/birds/fish	Not just an occasional road kill, but numerous animals (wild and domestic, small and large), birds, and fish in the same area.
Lack of insect life	If normal insect activity (ground, air, and/or water) is missing, check the ground, water surface or shore line for dead insects. If near water, check for dead fish and/or aquatic birds.
Unexplained odors	Possible odors include fruity, flowery, sharp, pungent, garlic, horseradish-like, bitter almonds, peach kernels, or newly mown hay. The odor is completely out of character with its surroundings.
Unusual numbers of dying or sick people (mass casualties)	Health problems including nausea, disorientation, difficulty in breathing, convulsions, localized sweating, conjunctivitis (reddening of eyes), erythema (reddening of skin) and death.
Pattern of casualties	Casualties will likely be distributed downwind, or if indoors, by the air ventilation system.
Blisters or rashes	Numerous people experiencing unexplained water-like blisters, weals (like bee stings), and/or rashes.
Illness in confined area	Different casualty rates for people working indoors versus outdoors dependent on where the agent was released.
Unusual liquid droplets	Numerous surfaces show oily droplets or film; numerous water surfaces have an oily film (no recent rain).
Different-looking areas	Not just a patch of dead weeds, but trees, shrubs, bushes, food crops, and/or lawns that are dead, discolored, or withered (no current drought).
Low-lying clouds	Low-lying cloud or fog-like condition not consistent with its surroundings.
Unusual metal debris	Unexplained bomb or munitions-like material, especially if it contains a liquid.

INDICATORS OF A POSSIBLE BIOLOGICAL INCIDENT

Unusual numbers of sick or dying people or animals	Any number of symptoms may occur. Casualties may occur hours to days after an incident has occurred. The time required before symptoms are observed is dependent on the agent.
Unscheduled and unusual spray being disseminated	Especially if outdoors during periods of darkness.
Abandoned spray devices	Devices may not have distinct odors.

INDICATORS OF A POSSIBLE RADIOLOGICAL INCIDENT

Radiation Symbols	Containers may display a “propeller” radiation symbol.
Unusual metal debris	Unexplained bomb or munitions-like material.
Heat-emitting material	Material that is hot or seems to emit heat without any sign of an external heat source.
Glowing material	Strongly radioactive material may emit or cause radioluminescence.
Sick people/animals	In very improbable scenarios there may be unusual numbers of sick or dying people or animals. Casualties may occur hours to days or weeks after an incident has occurred. The time required before symptoms are observed is dependent on the radioactive material used, and the dose received. Possible symptoms include skin reddening or vomiting.

PERSONAL SAFETY CONSIDERATIONS

When you approach a scene that may involve CB agents or radioactive materials, the most critical thing to consider is your safety and that of other responders.

Use protective clothing and respiratory protection of an appropriate level of safety. In incidents where you suspect that CBRN materials have been used as weapons, NIOSH-certified respirators with CBRN protection are highly recommended. Be aware that you may not be able to verify or identify CB agents or radioactive materials, especially in the case of biological or radiological agents.

The following actions apply to a chemical, biological or radiological incident. This guidance is general. Responders will need to apply it on a case-by-case basis.

Approach and response strategies:

- Minimize exposure time.
- Maximize the distance between you and the item that is likely to harm you.
- Use cover as protection.

- Wear appropriate personal protective equipment and respiratory protection.
- Identify and estimate the hazard by using the indicators above.
- Isolate the area and secure the scene.
- Isolate and decontaminate potentially contaminated people as soon as possible.
- To the extent possible, take measures to limit the spread of contamination.

In the event of a **chemical** incident, the fading of chemical odors does not necessarily indicate reduced vapor concentrations. Some chemicals deaden the senses, giving you the false perception that the chemical is no longer present.

If there is any indication that an area may be contaminated with **radioactive** materials, including the site of any non-accidental explosion, responders:

- should be equipped with radiation detection equipment
- should have adequate training in how to use this equipment

This equipment should be designed to also alert responders when an unacceptable ambient dose rate or ambient dose has been reached.

Initial actions to consider in a potential CBRN/terrorism event:

- Avoid using cell phones, radios, etc. within 100 meters (300 feet) of a suspect device.
- Notify your local police by calling 911.
- Set up incident command upwind and uphill of the area.
- Do **not** touch or move suspicious packages or containers.
- Be cautious about the potential presence of secondary devices (e.g., improvised explosive devices (IEDs)).
- Avoid contamination.
- Limit access to only those responsible for rescue of victims or assessment of unknown materials or devices.
- Evacuate and isolate people who were potentially exposed to hazardous materials/ dangerous goods.
- Isolate contaminated areas and secure the scene for analysis of material.

DECONTAMINATION MEASURES

For chemical and biological agents: Emergency responders should follow standard decontamination procedures (flush-strip-flush). Mass casualty decontamination should begin as soon as possible by stripping all clothing, and flushing with soap and water. For further information, contact the agencies listed on the inside back cover of this guidebook.

For people contaminated with radioactive material: Take care to minimize the spread of the contamination to the extent possible. Move them to a low radiation area if necessary, and if it can be done safely. Remove their clothing and place it in a clearly marked and sealed receptacle, such as a plastic bag, for later testing. Use decontamination methods

described above, but avoid breaking the skin (e.g., vigorous brushing). External radiological contamination on intact skin rarely causes a high enough dose to be a hazard, to either the contaminated individual or the first responders. For this reason, prioritize medical stabilization for a contaminated injured individual.









NOTE: The above information was developed in part by the Department of National Defence (Canada), the U.S. Department of the Army, Aberdeen Proving Ground and the Federal Bureau of Investigation (FBI).

IMPROVISED EXPLOSIVE DEVICE (IED)

An IED is a “homemade” bomb and/or destructive device used to destroy, incapacitate, harass, or distract. Because they are improvised, IEDs can come in many forms, ranging from a small pipe bomb to a sophisticated device capable of causing massive damage and loss of life.

The following table predicts the damage radius based on the volume or weight of explosive (TNT equivalent) and the type of bomb.

Improvised Explosive Device (IED) SAFE STAND-OFF DISTANCE

Threat Description	Explosives Capacity ¹	Mandatory Evacuation Distance ²	Shelter-in-Place Zone	Preferred Evacuation Distance ³
 Pipe Bomb	5 lbs 2.3 kg	70 ft 21 m	71 - 1,199 ft 22 - 365 m	+1,200 ft 366 m
 Suicide Bomber	20 lbs 9 kg	110 ft 34 m	111 - 1,699 ft 35 - 518 m	+1,700 ft 519 m
 Briefcase/Suitcase	50 lbs 23 kg	150 ft 46 m	151 - 1,849 ft 47 - 563 m	+1,850 ft 564 m
 Car	500 lbs 227 kg	320 ft 98 m	321 - 1,899 ft 99 - 579 m	+1,900 ft 580 m
 SUV/Van	1,000 lbs 454 kg	400 ft 122 m	401 - 2,399 ft 123 - 731 m	+2,400 ft 732 m
 Small Delivery Truck	4,000 lbs 1,814 kg	640 ft 195 m	641 - 3,799 ft 196 - 1,158 m	+3,800 ft 1,159 m
 Container/Water Truck	10,000 lbs 4,536 kg	860 ft 263 m	861 - 5,099 ft 264 - 1,554 m	+5,100 ft 1,555 m
 Semi-Trailer	60,000 lbs 27,216 kg	1,570 ft 475 m	1,571 - 9,299 ft 476 - 2,834 m	+9,300 ft 2,835 m

High Explosives (TNT Equivalent)

¹ Based on the maximum amount of material that could reasonably fit into a container or vehicle. Variations possible.

² Governed by the ability of an unreinforced building to withstand severe damage or collapse.

³ Governed by the greater of fragment throw distance or glass breakage/falling glass hazard distance. These distances can be reduced for personnel wearing ballistic protection. Note that the pipe bomb, suicide bomb, and briefcase/suitcase bomb are assumed to have a fragmentation characteristic that requires greater stand-off distances than an equal amount of explosives in a vehicle.

Improvised Explosive Device (IED) SAFE STAND-OFF DISTANCE

Threat Description	LPG Mass / Volume ¹	Fireball Diameter ²	Safe Distance ^{3,4}
Small LPG Tank	20 lbs / 5 gal	40 ft	160 ft
Large LPG Tank	100 lbs / 25 gal	69 ft	276 ft
Commercial/Residential LPG Tank	2,000 lbs / 500 gal	184 ft	736 ft
Small LPG Truck	8,000 lbs / 2,000 gal	292 ft	1,168 ft
Semitanker LPG	40,000 lbs / 10,000 gal	499 ft	1,996 ft

LPG - Butane or Propane

¹ Based on the maximum amount of LPG that could reasonably fit into a container or vehicle. Variations possible.

² Assuming efficient mixing of the flammable gas with ambient air.

³ Determined by U.S. firefighting practices wherein safe distances are approximately 4 times the flame height.

⁴ This table is for a loaded LPG tank with explosives on the exterior. Note that an LPG tank filled with high explosives would require a significantly greater stand-off distance than if it were filled with LPG.

GLOSSARY

Adsorbed gas	A gas which sticks (adsorbs) to the surface of a solid and porous material (such as activated charcoal) contained within a metal cylinder. This results in an internal cylinder pressure of less than 101.3 kPa at 20°C (14 psi at 68°F) and less than 300 kPa at 50°C (43 psi at 122°F). These pressures are much lower than those of conventional cylinders containing compressed or liquefied gases.
AEGL(s)	Acute Exposure Guideline Level(s), AEGLs represent threshold exposure limits for the general public after a once-in-a-lifetime, or rare, exposure and are applicable to emergency exposure periods ranging from 10 minutes to 8 hours. Three levels AEGL-1, AEGL-2 and AEGL-3 are developed for each of five exposure periods (10 and 30 minutes, 1 hour, 4 hours, and 8 hours) and are distinguished by varying degrees of severity of toxic effects; see AEGL-1, AEGL-2 and AEGL-3.
AEGL-1	AEGL-1 is the airborne concentration (expressed as parts per million or milligrams per cubic meter [ppm or mg/m ³]) of a substance above which it is predicted that the general population, including susceptible individuals, could experience notable discomfort, irritation, or certain asymptomatic, non-sensory effects. However, the effects are not disabling and are transient and reversible upon cessation of exposure.
AEGL-2	AEGL-2 is the airborne concentration (expressed as ppm or mg/m ³) of a substance above which it is predicted that the general population, including susceptible individuals, could experience irreversible or other serious, long-lasting adverse health effects or an impaired ability to escape.
AEGL-3	AEGL-3 is the airborne concentration (expressed as ppm or mg/m ³) of a substance above which it is predicted that the general population, including susceptible individuals, could experience life-threatening health effects or death.
Alcohol-resistant foam	A foam that is resistant to polar chemicals such as ketones and esters which may break down other types of foam.
Biological agents	Pathogens (bacteria, viruses, etc.) or the toxins they produce (such as anthrax) that are dispersed with criminal intent. They can cause disease or death in otherwise healthy humans. Refer to GUIDE 158.
BLEVE	Boiling Liquid Expanding Vapor Explosion

GLOSSARY

Blister agents (vesicants)	<p>Substances that cause blistering of the skin. Exposure is through liquid or vapor contact with any exposed tissue (eyes, skin, lungs). Mustard (H), Distilled Mustard (HD), Nitrogen Mustard (HN) and Lewisite (L) are blister agents.</p> <p>Symptoms: Red eyes, skin irritation, burning of skin, blisters, upper respiratory damage, cough, hoarseness.</p>
Blood agents	<p>Substances that injure a person by interfering with cell respiration (the exchange of oxygen and carbon dioxide between blood and tissues). Hydrogen cyanide (AC) and Cyanogen chloride (CK) are blood agents.</p> <p>Symptoms: Respiratory distress, headache, unresponsiveness, seizures, coma.</p>
Boil over	<p>A sudden increase in fire intensity associated with the expulsion of burning flammable liquid caused by the boiling of water that has accumulated in the bottom of a tank car.</p>
Burn	<p>Refers to either a chemical or thermal burn, the former may be caused by corrosive substances and the latter by liquefied cryogenic gases, hot molten substances, or flames.</p>
Carcinogen	<p>A substance or mixture which induces cancer or increases its incidence.</p>
Category A	<p>An infectious substance that poses a high risk to the health of individuals and/or animals or public health. These substances can cause serious disease and can lead to death. Effective treatment and preventative measures may not be available.</p>
Category B	<p>An infectious substance that poses a low to moderate risk to individuals and/or animals and/or public health. These substances are unlikely to cause serious disease. Effective treatment and preventative measures are available.</p>
CBRN	<p>Chemical, biological, radiological or nuclear agent.</p>
Choking agents	<p>Substances that cause physical injury to the lungs. Exposure is through inhalation. In extreme cases, membranes swell and lungs become filled with liquid (pulmonary edema). Death results from lack of oxygen; hence, the victim is "choked". Phosgene (CG) is a choking agent.</p> <p>Symptoms: Irritation to eyes/nose/throat, respiratory distress, nausea and vomiting, burning of exposed skin.</p>
CO₂	<p>Carbon dioxide gas.</p>

GLOSSARY

- Cold zone** Area where the command post and support functions that are necessary to control the incident are located. This is also referred to as the clean zone, green zone or support zone in other documents. (EPA Standard Operating Safety Guidelines, OSHA 29 CFR 1910.120, NFPA 472).
- Combustible liquid** Liquids which have a flash point greater than 60°C (140°F) and below 93°C (200°F). U.S. regulations permit a flammable liquid with a flash point between 38°C (100°F) and 60°C (140°F) to be reclassified as a combustible liquid.
- Compatibility Group** Letters identify explosives that are deemed to be compatible. The definition of these Compatibility Groups in this Glossary are intended to be descriptive. Please consult the transportation of hazardous materials/dangerous goods or explosives regulations of your jurisdiction for the exact wording of the definitions. Class 1 materials are considered to be “compatible” if they can be transported together without significantly increasing either the probability of an incident or, for a given quantity, the magnitude of the effects of such an incident.
- A Substances which are expected to mass detonate very soon after fire reaches them.
- B Articles which are expected to mass detonate very soon after fire reaches them.
- C Substances or articles which may be readily ignited and burn violently without necessarily exploding.
- D Substances or articles which may mass detonate (with blast and/or fragment hazard) when exposed to fire.
- E & F Articles which may mass detonate in a fire.
- G Substances and articles which may mass explode and give off smoke or toxic gases.
- H Articles which in a fire may eject hazardous projectiles and dense white smoke.
- J Articles which may mass explode.
- K Articles which in a fire may eject hazardous projectiles and toxic gases.
- L Substances and articles which present a special risk and could be activated by exposure to air or water.

GLOSSARY

Compatibility Group (continued)	N	Articles which contain only extremely insensitive detonating substances and demonstrate a negligible probability of accidental ignition or propagation.
	S	Packaged substances or articles which, if accidentally initiated, produce effects that are usually confined to the immediate vicinity.
Control zones		Designated areas at hazardous materials/dangerous goods incidents, based on safety and the degree of hazard. Many terms are used to describe control zones; however, in this guidebook, these zones are defined as the hot/exclusion/red/restricted zone, warm/contamination reduction/yellow/limited access zone, and cold/support/green/clean zone. (EPA Standard Operating Safety Guidelines, OSHA 29 CFR 1910.120, NFPA 472).
Cryogenic liquid		A refrigerated, liquefied gas that has a boiling point colder than -90°C (-130°F) at atmospheric pressure or is handled or transported at a temperature equal to or less than -100°C (-148°F).
Decomposition products		Products of a chemical or thermal break-down of a substance.
Decontamination		The removal of hazardous materials/dangerous goods from personnel and equipment to the extent necessary to prevent potential adverse health effects. See "Decontamination", page 362.
Dry chemical		A preparation designed for fighting fires involving flammable liquids, pyrophoric substances and electrical equipment. Common types contain sodium bicarbonate or potassium bicarbonate.
Edema		The accumulation of an excessive amount of watery fluid in cells and tissues. Pulmonary edema is an excessive buildup of water in the lungs, for instance, after inhalation of a gas that is corrosive to lung tissue.
ERPG(s)		Emergency Response Planning Guideline(s). Values intended to provide estimates of concentration ranges above which one could reasonably anticipate observing adverse health effects; see ERPG-1, ERPG-2 and ERPG-3.
ERPG-1		The maximum airborne concentration below which it is believed nearly all individuals could be exposed for up to 1 hour without experiencing more than mild, transient adverse health effects or without perceiving a clearly defined objectionable odor.

GLOSSARY

ERPG-2	The maximum airborne concentration below which it is believed nearly all individuals could be exposed for up to 1 hour without experiencing or developing irreversible or other serious health effects or symptoms that could impair an individual's ability to take protective action.
ERPG-3	The maximum airborne concentration below which it is believed nearly all individuals could be exposed for up to 1 hour without experiencing or developing life-threatening health effects.
Flammable liquid	A liquid that has a flash point of 60°C (140°F) or lower.
Flash point	Lowest temperature at which a liquid or solid gives off vapor in such a concentration that, when the vapor combines with air near the surface of the liquid or solid, a flammable mixture is formed. Hence, the lower the flash point, the more flammable the material.
Flooding quantities	Minimum of 1900 L/min (500 US gal/min) of water.
Hazard zones (Inhalation Hazard Zones)	HAZARD ZONE A: Gases: LC50 of less than or equal to 200 ppm, Liquids: V equal to or greater than 500 LC50 and LC50 less than or equal to 200 ppm. HAZARD ZONE B: Gases: LC50 greater than 200 ppm and less than or equal to 1000 ppm, Liquids: V equal to or greater than 10 LC50; LC50 less than or equal to 1000 ppm and criteria for Hazard Zone A are not met. HAZARD ZONE C: LC50 greater than 1000 ppm and less than or equal to 3000 ppm. HAZARD ZONE D: LC50 greater than 3000 ppm and less than or equal to 5000 ppm. Please note: even though the term “zone” is used, hazard zones are not an actual area or distance. How zones are assigned is strictly a function of the lethal concentration 50 (LC50) of the product. For example, TIH Zone A is more toxic than Zone D.
High expansion foam	Foams that have a high expansion ratio (over 1:200) with a low water content.
Hot zone	Area immediately surrounding a hazardous materials/dangerous goods incident which extends far enough to prevent adverse effects from the released product to personnel outside the zone. This zone is also referred to as exclusion zone, red zone or restricted zone in other documents. (EPA Standard Operating Safety Guidelines, OSHA 29 CFR 1910.120, NFPA 472).
IED	See “Improvised Explosive Device”.

GLOSSARY

Immiscible	In this guidebook, means that a material does not mix readily with water.
Improvised Explosive Device	A bomb that is manufactured from commercial, military or homemade explosives.
Large spill	A spill that involves quantities that are greater than 208 liters (55 US gallons). This usually involves a spill from a large package, or multiple spills from many small packages.
LC50	Lethal concentration 50. The concentration of a material administered by inhalation that is expected to cause the death of 50% of an experimental animal population within a specified time. (Concentration is reported in either ppm or mg/m ³).
Mass explosion	Explosion which affects almost the entire load virtually instantaneously.
MAWP	Maximum Allowable Working Pressure: The maximum allowable internal pressure that the tank may experience during normal operations.
mg/m³	Milligrams of a material per cubic meter of air.
Miscible	In this guidebook, means that a material mixes readily with water.
mL/m³	Milliliters of a material per cubic meter of air. (1 mL/m ³ equals 1 ppm).
Mutagen	An agent giving rise to an increased occurrence of mutations in populations of cells and/or organisms. Mutation means a permanent change in the amount or structure of the genetic material in a cell.
Narcotic	A substance which acts as a central nervous system depressor producing effects such as drowsiness, narcosis, reduced alertness, loss of reflexes, lack of coordination, and vertigo. These effects can also be manifested as severe headache or nausea, and can lead to reduced judgment, dizziness, irritability, fatigue, impaired memory function, deficit in perception and coordination, reaction time, or sleepiness.
Nerve agents	Substances that interfere with the central nervous system. Exposure is primarily through contact with the liquid (via skin and eyes) and secondarily through inhalation of the vapor. Tabun (GA), Sarin (GB), Soman (GD) and VX are nerve agents. Symptoms: Pinpoint pupils, extreme headache, severe tightness in the chest, dyspnea, runny nose, coughing, salivation, unresponsiveness, seizures.

GLOSSARY

n.o.s.	These letters refer to “not otherwise specified”. The entries which use this description are generic names such as “Corrosive liquid, n.o.s.” This means that the actual chemical name for that corrosive liquid is not listed in the regulations; therefore, a generic name must be used to describe it on shipping papers.
Noxious	In this guidebook, means that a material may be harmful or injurious to health or physical well-being.
Organic Peroxide	An organic (carbon-containing) compound having two oxygen atoms joined together. Organic peroxides are thermally unstable chemicals. They may have one or more of the following properties: be liable to explosive decomposition; burn rapidly; be sensitive to impact or friction; react dangerously with other substances.
Oxidizer	A chemical which supplies its own oxygen and which helps other combustible material burn more readily.
P	See “Polymerization”.
Packing Group	The Packing Group (PG) is assigned based on the degree of danger presented by the hazardous material/dangerous good: PG I : Great danger PG II : Medium danger PG III : Minor danger
PG	See “Packing Group”.
pH	pH is a value that represents the acidity or alkalinity of a water solution. Pure water has a pH of 7. A pH value below 7 indicates an acid solution (a pH of 1 is extremely acidic). A pH above 7 indicates an alkaline solution (a pH of 14 is extremely alkaline). Acids and alkalies (bases) are commonly referred to as corrosive materials.
PIH	Poison Inhalation Hazard. See “TIH”.
Polar	See “Miscible”.
Polymerization	A chemical reaction that often produces heat and pressure. Once initiated, the reaction is accelerated by the heat that it produces. The uncontrolled buildup of heat and pressure can cause a fire or an explosion, or can rupture closed containers. The letter (P) following a guide number in the yellow-bordered and blue-bordered pages identifies a material that may polymerize violently under high temperature conditions or contamination with other products during a transportation incident. It is also used to identify materials that have a strong potential for polymerization in the absence of an inhibitor due to depletion of this inhibitor caused by accident conditions.

GLOSSARY

ppm	Parts per million. (1 ppm equals 1 mL/m ³).
Protective clothing	<p>In this guidebook, protective clothing includes both respiratory and physical protection. One cannot assign a level of protection to clothing or respiratory devices separately. These levels were accepted and defined by response organizations such as U.S. Coast Guard, NIOSH, and U.S. EPA.</p> <p>Level A: SCBA plus totally encapsulating chemical resistant clothing (permeation resistant).</p> <p>Level B: SCBA plus hooded chemical resistant clothing (splash suit).</p> <p>Level C: Full or half-face respirator plus hooded chemical resistant clothing (splash suit).</p> <p>Level D: Coverall, including structural firefighters' protective clothing (SFPC), with no respiratory protection.</p> <p>SCBA: Self-contained breathing apparatus.</p> <p>Consult "Protective Clothing", pages 360-361</p>
Pyrophoric	A material which ignites spontaneously upon exposure to air (or oxygen).
Radiation Authority	As referred to in GUIDES 161 through 166 for radioactive materials, the Radiation Authority is either a Federal, state/provincial agency or state/province designated official. The responsibilities of this authority include evaluating radiological hazard conditions during normal operations and during emergencies. If the identity and telephone number of the authority are not known by emergency responders, or included in the local response plan, the information can be obtained from the agencies listed on the inside back cover. They maintain a periodically updated list of radiation authorities.
Radioactivity	The property of some substances to emit invisible and potentially harmful radiation.
Refrigerated liquid	See "Refrigerated liquefied gas".
Refrigerated liquefied gas	A gas which when packaged for transport is made partially liquid because of its low temperature. See "Cryogenic liquid".
Respiratory sensitizer	A substance that induces hypersensitivity of the airways following inhalation of the substance.
Right-of-way	A defined area on a property containing one or more high-pressure natural gas pipelines.

GLOSSARY

Shelter-in-place	People should seek shelter inside a building and remain inside until the danger passes. Sheltering-in-place is used when evacuating the public would cause greater risk than staying where they are, or when an evacuation cannot be performed. Direct the people inside to close all doors and windows and to shut off all ventilating, heating and cooling systems. In-place protection (shelter-in-place) may not be the best option if (a) the vapors are flammable; (b) if it will take a long time for the gas to clear the area; or (c) if buildings cannot be closed tightly. Vehicles can offer some protection for a short period if the windows are closed and the ventilating systems are shut off. Vehicles are not as effective as buildings for in-place protection.
Skin corrosion	The production of irreversible damage to the skin following the application of a test substance for up to 4 hours.
Skin irritation	The production of reversible damage to the skin following the application of a test substance for up to 4 hours.
Skin sensitizer	A substance that will induce an allergic response following skin contact.
Small spill	A spill that involves quantities that are 208 liters (55 US gallons) or less. This generally corresponds to a spill from a single small package (for example, a drum), a small cylinder, or a small leak from a large package.
Specific gravity	Weight of a substance compared to the weight of an equal volume of water at a given temperature. Specific gravity less than 1 indicates a substance is lighter than water; specific gravity greater than 1 indicates a substance is heavier than water.
Straight (solid) stream	Method used to apply or distribute water from the end of a hose. The water is delivered under pressure for penetration. In an efficient straight (solid) stream, approximately 90% of the water passes through an imaginary circle 38 cm (15 inches) in diameter at the breaking point. Hose (solid or straight) streams are frequently used to cool tanks and other equipment exposed to flammable liquid fires, or for washing burning spills away from danger points. However, straight streams will cause a spill fire to spread if improperly used or when directed into open containers of flammable and combustible liquids.
TIH	Toxic Inhalation Hazard. Term used to describe gases and volatile liquids that are toxic when inhaled (same as PIH). These materials pose a known hazard to human health during transport or is presumed to be toxic to humans because of animal-based studies.

GLOSSARY

V	Saturated vapor concentration in air of a material in mL/m ³ (ppm) at 20°C and standard atmospheric pressure.
Vapor density	Weight of a volume of pure vapor or gas (with no air present) compared to the weight of an equal volume of dry air at the same temperature and pressure. A vapor density less than 1 (one) indicates that the vapor is lighter than air and will tend to rise. A vapor density greater than 1 (one) indicates that the vapor is heavier than air and may travel along the ground
Vapor pressure	Pressure at which a liquid and its vapor are in equilibrium at a given temperature. Liquids with high vapor pressures evaporate rapidly.
Viscosity	Measure of a liquid's internal resistance to flow. This property is important because it indicates how fast a material will leak out through holes in containers or tanks.
Warm zone	Area between Hot and Cold zones where personnel and equipment decontamination and hot zone support take place. It includes control points for the access corridor and thus assists in reducing the spread of contamination. Also referred to as the contamination reduction corridor (CRC), contamination reduction zone (CRZ), yellow zone or limited access zone in other documents. (EPA Standard Operating Safety Guidelines, OSHA 29 CFR 1910.120, NFPA 472).
Water Reactive Material	In this guidebook, materials which produce significant toxic gas when it comes in contact with water.
Water-sensitive	Substances which may produce flammable and/or toxic decomposition products upon contact with water.

GLOSSARY

Water spray (fog)

Method or way to apply or distribute water. The water is finely divided to provide for high heat absorption. Water spray patterns can range from about 10 to 90 degrees. Water spray streams can be used to extinguish or control the burning of a fire or to provide exposure protection for personnel, equipment, buildings, etc. **(This method can be used to absorb vapors, knock-down vapors or disperse vapors. Direct a water spray (fog), rather than a straight (solid) stream, into the vapor cloud to accomplish any of the above).**

Water spray is particularly effective on fires of flammable liquids and volatile solids having flash points above 37.8°C (100°F).

Regardless of the above, water spray can be used successfully on flammable liquids with low flash points. The effectiveness depends particularly on the method of application. With proper nozzles, even gasoline spill fires of some types have been extinguished when coordinated hose lines were used to sweep the flames off the surface of the liquid. Furthermore, water spray carefully applied has frequently been used with success in extinguishing fires involving flammable liquids with high flash points (or any viscous liquids) by causing frothing to occur only on the surface, and this foaming action blankets and extinguishes the fire.

PUBLICATION DATA

The 2020 Emergency Response Guidebook (ERG2020) was prepared by the staff of Transport Canada, the U.S. Department of Transportation, and the Secretariat of Communications and Transport of Mexico with the assistance of many interested parties from government and industry including the collaboration of CIQUIME of Argentina. Printing and publication services are provided through U.S. DOT's Pipeline and Hazardous Materials Safety Administration (PHMSA), Outreach, Engagement, and Grants Division.

ERG2020 is based on earlier Transport Canada, U.S. DOT, and Secretariat of Communications and Transport emergency response guidebooks. ERG2020 is published in three languages: English, French and Spanish. The Emergency Response Guidebook has been translated and printed in other languages, including Chinese, German, Hebrew, Japanese, Portuguese, Korean, Hungarian, Polish, Turkish and Thai.

We encourage countries that wish to translate this Guidebook to please contact any of the websites or telephone numbers in the next paragraph.

DISTRIBUTION OF THIS GUIDEBOOK

The primary objective is to place one copy of the ERG2020 in each publicly owned emergency service vehicle through distribution to Federal, state, provincial and local public safety authorities. The distribution of this guidebook is being accomplished through the voluntary cooperation of a network of key agencies. Emergency service organizations that have not yet received copies of ERG2020 should contact the respective distribution center in their country, state or province. In the U.S., information about the distribution center for your location may be obtained from the Office of Hazardous Materials Safety website at <https://www.phmsa.dot.gov/hazmat/erg/emergency-response-guidebook-erg> or call 202-366-4900. In Canada, contact CANUTEC at 1-888-706-0195 or via the website at <https://www.tc.gc.ca/canutec> for information. In Mexico, call SCT at +52 55-57-23-93-00 ext. 20010 or 20577, or via email at cserrano@sct.gob.mx. In Argentina, call CIQUIME at +54-11-5199-1409, or via the website at <http://www.ciquime.org> or via email at gre@ciquime.org.

REPRODUCTION AND RESALE

Copies of this document which are provided free-of-charge to fire, police and other emergency services may not be resold. ERG2020 (PHH50-ERG2020) may be reproduced without further permission subject to the following:

The names and the seals of the participating governments may not be reproduced on a copy of this document unless that copy accurately reproduces the entire content (text, format, and coloration) of this document without modification. In addition, the publisher's full name and address must be displayed on the outside back cover of each copy, replacing the wording placed on the center of the back cover.

Constructive comments concerning ERG2020 are solicited; in particular, comments concerning its use in handling incidents involving hazardous materials/dangerous goods. Comments should be addressed to:

In Canada:

Director, CANUTEC
Transport Dangerous Goods
Transport Canada
Ottawa, Ontario
Canada K1A 0N5

Phone: 613-992-4624 (information)

Fax: 613-954-5101

Email: canutec@tc.gc.ca

In the U.S.:

U. S. Department of Transportation
Pipeline and Hazardous Materials Safety Administration
Outreach, Engagement, and Grants Division (PHH-50)
Washington, DC 20590-0001

Phone: 202-366-4900

Fax: 202-366-7342

Email: ERGComments@dot.gov

In Mexico:

Secretaría de Comunicaciones y Transportes
Dirección General de Autotransporte Federal
Dirección General Adjunta de Normas y Especificaciones
Técnicas y de Seguridad en el Autotransporte
Calzada de las Bombas No. 411-2 piso,
Col. Los Girasoles,
Alcaldía de Coyoacán,
Código Postal 04920,
Ciudad de México

Phone: +52 55-57-23-93-00 ext. 20010 or 20577

Email: cserrano@sct.gob.mx

In Argentina:

Centro de Información Química para Emergencias (CIQUIME)
Av. Alvarez Thomas 636
C1427CCT Buenos Aires, Argentina
Phone: +54-11-5199-1409
Email: gre@ciquime.org

The Emergency Response Guidebook is normally revised and reissued every four years. However, in the event of a significant mistake, omission or change in the state of knowledge, special instructions to change the guidebook (in pen-and-ink, with paste-over stickers, or with a supplement) may be issued.

Users of this guidebook should check periodically (about every 6 months) to make sure their version is current. Changes should be annotated below. Contact:

DOT/PHMSA

<https://www.phmsa.dot.gov/hazmat/erg/emergency-response-guidebook-erg>

TRANSPORT CANADA

<https://www.tc.gc.ca/eng/canutec/menu.htm>

CIQUIME

<http://www.ciquime.org>

This guidebook incorporates changes dated:

CANADA AND UNITED STATES NATIONAL RESPONSE CENTERS

For the purposes of this guidebook, the terms hazardous materials/dangerous goods are synonymous.

CANADA

1. **CANUTEC**

CANUTEC is the **Canadian Transport Emergency Centre** operated by the Transportation of Dangerous Goods Directorate of Transport Canada.

CANUTEC provides a national bilingual (French and English) advisory service and is staffed by professional scientists experienced and trained in interpreting technical information and providing emergency response advice.

**In an emergency, CANUTEC may be called at 1-888-CANUTEC (226-8832)
or collect at 613-996-6666 (24 hours)
*666 cellular (Press Star 666, Canada only)**

In a non-emergency situation, please call the information line at 613-992-4624 (24 hours).

2. **PROVINCIAL/TERRITORIAL AGENCIES**

Although technical information and emergency response assistance can be obtained from **CANUTEC**, there are federal, provincial and territorial regulations requiring the reporting of dangerous goods incidents to certain authorities.

The following list of provincial/territorial agencies is supplied for your convenience.

Province	Emergency Authority and/or Telephone Number
Alberta	Local Police and Provincial Authorities 1-800-272-9600 or 780-422-9600
British Columbia	Local Police and Provincial Authorities 1-800-663-3456
Manitoba	Provincial Authority 204-945-4888 and Local Police or fire brigade, as appropriate
New Brunswick	Local Police or 1-800-565-1633
Newfoundland and Labrador	Local Police and 709-772-2083
Northwest Territories.....	867-920-8130
Nova Scotia	Local Police or 1-800-565-1633
Nunavut	Local Police and 867-920-8130
Ontario.....	Local Police
Prince Edward Island.....	Local Police or 1-800-565-1633
Quebec	Local Police
Saskatchewan	Local Police or 1-800-667-7525
Yukon Territory.....	867-667-7244

NOTE:

1. The appropriate federal agency must be notified in the case of rail, air or marine incidents.
2. The nearest police department must be notified in the case of lost, stolen or misplaced explosives, radioactive materials or infectious substances.
3. **CANUTEC must** be notified in the case of:
 - a. lost, stolen or unlawfully interfered with dangerous goods (except Class 9)
 - b. an incident involving infectious substances
 - c. an accidental release from a cylinder that has suffered a catastrophic failure
 - d. an incident where the shipping papers display **CANUTEC's** telephone number 1-888-CANUTEC (226-8832) or 613-996-6666 as the emergency telephone number or
 - e. a dangerous goods incident in which a railway vehicle, a ship, an aircraft, an aerodrome or an air cargo facility is involved
3. **EMERGENCY RESPONSE ASSISTANCE PLANS (Applies in Canada ONLY)**

An ERAP or Emergency Response Assistance Plan is an approved plan that describes what is to be done in the event of a transportation accident involving certain higher risk dangerous goods. The ERAP is required by the Canadian *Transportation of Dangerous Goods Act* for dangerous goods that require special expertise and response equipment to respond to an incident. The plan is intended to assist local emergency responders by providing them with technical experts and specially trained and equipped emergency response personnel at the scene of a dangerous goods incident.

The ERAP will describe the specialized response capabilities, equipment and procedures that will be used to support a response to incidents involving high risk dangerous goods. The plan will also address emergency preparedness, including personnel training, response exercises and equipment maintenance. The ERAP plans supplement those of the carrier and of the local and provincial authorities, and must be integrated with other organizations to help mitigate the consequences of an accident.

For shipments that require an ERAP, the ERAP number and the phone number to activate the ERAP will be included on the shipping paper. If additional information is required, or to determine if the product involved in the emergency requires an ERAP, contact **CANUTEC**.

**CANUTEC may be called at 1-888-CANUTEC (226-8832)
or collect at 613-996-6666 (24 hours)
*666 on cellular phone (Press star 666) In Canada Only**

NATIONAL RESPONSE CENTER (NRC)

The NRC, which is operated by the U.S. Coast Guard, receives reports required when hazardous materials are spilled. After receiving notification of an incident, the NRC will immediately notify the appropriate Federal On-Scene Coordinator and concerned Federal agencies. Federal law requires that anyone who releases into the environment a reportable quantity of a hazardous material (including oil when water is, or may be affected) or a material identified as a marine pollutant, must **immediately** notify the NRC. When in doubt as to whether the amount released equals the required reporting levels for these materials, the NRC should be notified.

CALL NRC (24 hours)

1-800-424-8802

(Toll-free in the U.S., Canada, and the U.S. Virgin Islands)

202-267-2675 in the District of Columbia

Calling the emergency response telephone number, CHEMTREC®, CHEMTEL, INC., INFOTRAC or 3E COMPANY, does not constitute compliance with regulatory requirements to call the NRC.

24-HOUR EMERGENCY RESPONSE TELEPHONE NUMBERS

MEXICO

1. CENACOM

555128-0000 extensions 36428, 36422, 36469, 37807, 37810

2. CONASENUSA

800-11-131-68 in the Republic of Mexico

3. SETIQ

800-00-21-400 or 55-5559-1588

For calls originating elsewhere, call: +52-55-5559-1588

ARGENTINA

1. CIQUIME

0-800-222-2933 in the Republic of Argentina

For calls originating elsewhere, call: +54-11-4552-8747*

BRAZIL

1. PRÓ-QUÍMICA

0-800-118270 in Brazil

For calls originating elsewhere, call: +55-19-3833-5310*

COLOMBIA

1. CISPROQUIM

01-800-091-6012 in Colombia

For calls originating in Bogotá, Colombia call: 288-6012

For calls originating elsewhere call: +57-1-288-6012

CHILE

1. CITUC QUÍMICO

2-2247-3600 in the Republic of Chile

For calls originating elsewhere call +56-2-2247-3600

* Collect calls are accepted

24-HOUR EMERGENCY RESPONSE TELEPHONE NUMBERS

CANADA

1. CANUTEC

1-888-CANUTEC (226-8832) or 613-996-6666 *
***666 (STAR 666) cellular (in Canada only)**

UNITED STATES

1. CHEMTREC

1-800-424-9300
(in the U.S., Canada and the U.S. Virgin Islands)
For calls originating elsewhere: **703-527-3887 ***

2. CHEMTEL, INC.

1-888-255-3924
(in the U.S., Canada, Puerto Rico and the U.S. Virgin Islands)
For calls originating elsewhere: **813-248-0573 ***

3. INFOTRAC

1-800-535-5053
(in the U.S., Canada and the U.S. Virgin Islands)
For calls originating elsewhere: **352-323-3500 ***

4. VERISK 3E

1-800-451-8346
(in the U.S., Canada and the U.S. Virgin Islands)
For calls originating elsewhere: **760-602-8703 ***

The emergency response information services shown above maintain periodically updated lists of state and Federal radiation authorities who provide information and technical assistance on handling incidents involving radioactive materials.

5. MILITARY SHIPMENTS, for assistance at incidents involving materials being shipped by, for, or to the Department of Defense (DOD), call one of the following numbers:

703-697-0218 * - Explosives/ammunition incidents
(U.S. Army Operations Center)

1-800-851-8061 - All other hazardous materials/dangerous goods incidents
(Defense Logistics Agency)

6. NATIONWIDE POISON CONTROL CENTER (United States only)

1-800-222-1222

* Collect calls are accepted

A guidebook intended for use by first responders
during the initial phase of a transportation incident
involving hazardous materials/dangerous goods

**THIS DOCUMENT SHOULD NOT BE USED TO
DETERMINE COMPLIANCE WITH THE
HAZARDOUS MATERIALS/
DANGEROUS GOODS REGULATIONS
OR
TO CREATE WORKER SAFETY DOCUMENTS
FOR SPECIFIC CHEMICALS**

NOT FOR SALE

**This document is intended for distribution
free of charge to Public Safety Organizations
by the US Department of Transportation and
Transport Canada. This copy may not be
resold by commercial distributors.**



U.S. Department of Transportation

**Pipeline and Hazardous Materials
Safety Administration**

<https://www.phmsa.dot.gov/hazmat>



Transport
Canada

Transports
Canada

<https://www.tc.gc.ca/TDG>



SCT

SECRETARÍA DE
COMUNICACIONES
Y TRANSPORTES

<http://www.sct.gob.mx>